

THEORY AND RESEARCH IN  
**SOCIAL, HUMAN AND  
ADMINISTRATIVE SCIENCES**

*October 2022*

**EDITORS**

**ASSOC. PROF. DR. SALİH BATAL**

**ASSIST. PROF. DR. CEYLAN SÜLÜ AKGÜL**

**Genel Yayın Yönetmeni / Editor in Chief • C. Cansın Selin Temana**  
**Kapak & İç Tasarım / Cover & Interior Design • Serüven Yayınevi**  
**Birinci Basım / First Edition • © Ekim 2022**  
**ISBN • 978-605-71770-7-0**

**© copyright**

Bu kitabın yayın hakkı Serüven Yayınevi'ne aittir.

Kaynak gösterilmeden alıntı yapılamaz, izin almadan hiçbir yolla çoğaltılamaz.

The right to publish this book belongs to Serüven Publishing.

Citation can not be shown without the source, reproduced in any way without permission.

**Serüven Yayınevi / Serüven Publishing**

**Türkiye Adres / Turkey Address:** Yalı Mahallesi İstikbal Caddesi No:6

Güzelbahçe / İZMİR

**Telefon / Phone:** 05437675765

**web:** [www.seruvenyayinevi.com](http://www.seruvenyayinevi.com)

**e-mail:** [seruvenyayinevi@gmail.com](mailto:seruvenyayinevi@gmail.com)

**Baskı & Cilt / Printing & Volume**

Sertifika / Certificate No: 47083

# **Theory and Research in Social, Human and Administrative Sciences**

October 2022

## Editors

Assoc. Prof. Dr. Salih BATAL

Assist. Prof. Dr. Ceylan SÜLÜ AKGÜL





## CONTENTS

### Chapter 1

THE CONCEPT OF FLANEUR FROM MODERN SOCIETY TO  
THE NETWORK SOCIETY AND AN APPLICATION EXAMPLE:  
FLANEUR APP

Tüba KARAHİSAR..... 1

### Chapter 2

MIGRATION PERCEPTION IN LOCAL ADMINISTRATIONS: A  
CASE OF ÇANAKKALE MUNICIPALITY

Alper BİLGİLİ & Fatma HIRLAK.....25

### Chapter 3

TECHNOLOGICAL PROGRESS AND ECONOMIC GROWTH  
RELATIONSHIP: THE CASE OF TURKEY WITH ARTIFICIAL  
NEURAL NETWORKS METHOD

Nazlı SEYHAN & Burak SEYHAN.....39

### Chapter 4

FINANCE GEOGRAPHY

Sezen GÜNGÖR & Nihan TOMRİS KÜÇÜN &

Kader EROL & Hatice ER.....59

### Chapter 5

THE INFLUENCE OF DOGMATISM ON CONSUMER  
PREFERENCES IN REGARD TO CONSUMER  
ETHNOCENTRISM

Ulvi Cenap TOPÇU ..... 71

### Chapter 6

THE EFFECT OF SOCIAL MEDIA MARKETING PRACTICES  
ON GREEN PURCHASING BEHAVIOR

Tuğba YEĞİN .....87

Chapter 7

ASABIYYA AS A USEFUL CONCEPTUAL TOOL FOR THE  
PALESTINIAN CASE

Abdurrahman GÜMÜŞ..... 117

Chapter 8

AHP-TOPSIS INTEGRATED APPROACH IN USED CAR  
SELECTION AND AN APPLICATION

Hakan AYDOĞAN & Fatma AKGÜN ..... 137

Chapter 9

ANALYSIS OF THE RUSSIA-UKRAINE WAR IN TERMS OF  
CLIMATE CRISIS POLICIES: THE CASE OF THE EUROPEAN  
UNION

Selçuk GÜRÇAM ..... 159

Chapter 10

A NEW MODEL OF PUBLIC-PRIVATE PARTNERSHIP FOR  
DEVELOPING COUNTRIES

Özcan ERDOĞAN..... 185

Chapter 11

A SHORT RETROSPECTIVE REVIEW ON THE THEORETICAL  
FRAMEWORK OF AGGLOMERATION ECONOMIES

Oya KENT ..... 199

Chapter 12

CUSTOMER RELATIONSHIP MANAGEMENT'S IMPACT ON  
CUSTOMER SATISFACTION AND PERFORMANCE OF SALES  
PROFESSIONALS

Enis PEKER & Yalçın KIRDAR ..... 227

Chapter 13

READING INGMAR BERGMAN CINEMA FROM A  
CINEMATOGRAPHIC PERSPECTIVE THROUGH THE FILM  
SCENES FROM A MARRIAGE

Gözde SUNAL ..... 263

Chapter 14

EXAMINING THE IRANIAN NUCLEAR PROGRAM THROUGH  
THE DOMESTIC POLITICS MODEL

Erdal BAYAR.....275

Chapter 15

A RESEARCH ON CONSUMERS' ATTITUDES TOWARDS  
HALAL CERTIFIED PRODUCTS

İbrahim ALKARA.....295

Chapter 16

CRYPTOCURRENCY USER PROFILE AND PROBLEMATIC  
CRYPTOCURRENCY USAGE FREQUENCY IN TURKISH  
SOCIETY

Nurettin MENTEŞ & Mahmut BULUT & İlyas YOLBAŞ .....313

Chapter 17

IN SEARCH OF GRACE PALEY: INTERVIEWS AND STORIES

Sultan KOMUT BAKINÇ .....327

Chapter 18

THE USE OF SHORT STORIES IN LANGUAGE CLASSES:  
A SAMPLE ANALYSIS

Semra SARAÇOĞLU .....343

Chapter 19

DETERMINING THE FACTORS AFFECTING THE SELECTION  
OF RESEARCH ASSISTANT AND RANKING OF IMPORTANCE:  
EXAMPLE OF MANAGEMENT INFORMATION SYSTEMS  
DEPARTMENT

Fatma AKGUN & Alper AYTEKIN .....365

Chapter 20

ORIENTALISM(S) IN TWO EMPIRES: COMPARING VASILY  
VERESHCHAGIN AND OSMAN HAMDİ BEY

Fatma COŞKUNER.....383

Chapter 21

BETWEEN MYTH AND HISTORY: REFLECTIONS OF THE  
EUROPEAN BATTLE PAINTINGS IN NINETEENTH-CENTURY  
OTTOMAN IMPERIAL IMAGERY

Fatma COŞKUNER.....399

Chapter 22

DRIVERS OF FINANCIAL DEVELOPMENT FOR RUSSIA AND  
CHINA AS NEW-STATE CAPITALISTIC AND EX-COMMUNIST  
COUNTRIES: PERESTROIKA OR GLASNOST?

Mehmet KUZU .....423

Chapter 23

REFLECTION OF TURKISH MYTHOLOGICAL SYMBOLS ON  
PRINTMAKING ART

Dizar ERCIVAN ZENCIRCI.....437

Chapter 24

NONLINEAR CANONICAL CORRELATION ANALYSIS AND  
AN APPLICATION ON SOCIAL INSTITUTION AND GENDER  
INDEX

Dilek VEYSİKARANI & Çiğdem KOŞAR TAŞ &

Sibel ÖRK ÖZEL.....455

Chapter 25

INVESTIGATION OF FACTORS AFFECTING RELIGIOUS  
COPING IN THE PANDEMIC PROCESS: PERCEPTION OF  
SUBJECTIVE RELIGIOSITY, PRAYER, WORSHIP, AND SOME  
SOCIO-DEMOGRAPHIC FEATURES

Nurten KIMTER.....481

Chapter 26

MONETARY POLICY UNCERTAINTY AND STOCK MARKETS  
IN GCC COUNTRIES: EVIDENCE FROM METHOD OF  
MOMENTS QUANTILE REGRESSION APPROACH

Murat GUVEN & Merve ALTAYLAR.....507

“

# Chapter 1

**THE CONCEPT OF FLANEUR FROM  
MODERN SOCIETY TO THE NETWORK  
SOCIETY AND AN APPLICATION  
EXAMPLE: FLANEUR APP**

*Tüba KARAHİSAR<sup>1</sup>*

”

---

<sup>1</sup> Assoc. Prof. Tüba Karahisar, Uşak University, Orcid: 0000 0002 9952 8977

## INTRODUCTION

Since ancient times, human beings have been constantly on the move from one place to another due to wars, trade or unforgiving climatic conditions. The movements that started on foot have continued with automobiles, trains, ships and planes due to technological advancements. Now the Internet offers us opportunities such as visiting a virtual museum, choosing a book in a virtual library or visiting a city virtually from where we live. Thus, the view on the concept of time-space began to change. In this period of speed and rapid experience, which David Harvey describes as time-space compression, it is possible to “go” from one museum to another in different cities without leaving home. In fact, real-time and three-dimensional navigations in the metaverse will be possible in the near future.

Mentioned in the literature as the Grand Tour, the trips made by noble and wealthy English men to Europe after the Renaissance (17th - 19th centuries) in order to increase their knowledge and manners are remembered as a turning point in the history of travel. Especially with the industrial revolution, the separation of home and workplace, the beginning of the formation of large and crowded cities, and the innovations in transportation accelerated and facilitated the movement of people (Çallı, 2015). Passages where first innovations were seen and the increase in manufactured goods brought a new actor to the relationship of the modern individual with the city: the city traveler (flaneur).

The flaneur mentioned by Charles Baudelaire in his book *The Painter of Modern Life* is

“A city traveler who travels across the metropolis to its farthest corners, observes all aspects of modern life with great love, extracts it and records it in his memory. He shelters in crowds, breathes in crowds, becomes enchanted with crowds. He wanders in disguise. No one notices him; he notices everyone. He is a great judge of character.” (Baudelaire, 2013).

The flaneur wanders on foot, slowly like a tortoise, but in fact his walk is an act of observing and thinking rather than idly wandering. Whereas walking while also contemplating is popular in modern society, fast pace walking activities for just a bit of taste of surroundings are at the forefront in today’s society. Again, in modern society, the flaneur’s tour has no special purpose. It doesn’t matter if he gets lost in the city. Today, however, even though one desires to get lost, this is not possible due to the applications on mobile devices. In the network society as conceptualized by Castells, everything is interconnected: social media, applications, the interconnection of institutions, the traces left by individuals while surfing the Internet, the use of traces in the data pool of other travelers, being

online, GPS, etc. This has transformed the relationship of the individual with the city, and the character of the flaneur has been tried to be explained with the names such as “network flaneur”, or “virtual flaneur”.

The aim of the study, which deals with the transformation of the flaneur character in the modern society in the network society and the changes in the way the flaneur communicates with the city, is to determine how the flaneur character’s dynamics of integration with the city in the fluid network society change through a mobile application. This study examines the concept of transforming flaneur in the network society and is important and original in terms of revealing how the transformation happens with an application. For this purpose, the concept of flaneur in the network society was examined with the semi-structured interview method.

This study consists of three parts after the introduction. In the first part, urbanization and opposition to work, the reflection of the concept of flaneur in the field of literature are discussed, and in the second part, the biography of Walter Benjamin, the author of the *Passages*, and the reasons that prompted him to write about passages and flanerie are addressed. Then, the concepts of dandy, bohemian and flaneur are explained in detail and finally, the concept of flaneur and new media possibilities and the possible transformation of flaneur are discussed. In the third part, with reference to the findings obtained from the interview, the experience of traveling in today’s fluid and spectacle society was critically examined through the “Flaneur App” application.

## **1) Opposition to Urbanization and Work**

Each period has revealed its own urban structure due to common needs. The structure of Miletus, Ephesus, and Bergama and the structure of the cities in the second half of the 17th century, when the baroque understanding was dominant, are quite different. Cities that were formed after the industrial revolution in the 19th century are the places where population explosion took place (Keleş, 1993). At the end of the century, a mass society in which the manufacturing sector predominates instead of agriculture is mentioned, and at first, there was a flow of masses to the city and poor working conditions (Giddens & Sutton, 2020, s. 104, 105). While pre-industrial cities are religious and administrative cities where the economic function is put into the background, post-industrial cities are places where trade and industry, specialization and division of labor come to the forefront (Keleş, 1993). By saying that “behaviors, attitudes and ideological elements necessary for the survival and development of the capitalist mode of production were created within the new urban culture”,

Tekeli states that the concept of urbanization cannot be explained only by population growth (Tekeli, 2011).

At the beginning of the industrial revolution, the population migrated from the village to the city in masses and there was a population explosion. Thus, the workforce needed by the factories is ready to work. In the early days of the industrial revolution, men, women, the elderly and even children were forced to work under very difficult conditions, and labor and work became values that were glorified. With a brief look at the pre-industrial era with regard to the concept of work, however, it is seen that cynics, Buddhists and dervishes chose an isolated life because they opposed or rejected social values and rules. The most famous cynic, Diogenes of Sinope, led a reclusive life by rejecting property. Likewise, Buddhists lived away from passions, society and its rules. Content with themselves, Dervishes, like Diogenes, did not want to acquire property and lived their lives without a homeland (Süsem, 2019).

Religious discourses also helped work and capital accumulation in Europe. Examining the influence of sects on capitalism, Weber said for Catholics, “they are calmer; they are equipped with less motivation to earn”, while mentioning Protestants in his book, he said: “The statement of St. Paulus ‘He who does not work, neither shall he eat’ is valid for everyone. Unwillingness for work is a sign of a lack of blessedness” (Weber, 1999). The first objections to work, which is sanctified by almost all institutions of the society, including religion, were initiated by “idlers” (Coşkuner, 2014).

Before talking about flanerier, which is described as a stance against capitalism, consumption, division of labor and commodity fetishism, it would be appropriate to mention the philosophers and writers who expressed their opinions on the philosophy of work. Veblen says that low-incomers are always forced to work in order to live a life like the upper classes and to be able to climb the social ladder. Because the lower classes have no money or property, “work” is thus a source of pride for them. Using the concept of consumption as a keyword, Veblen emphasizes that the lower classes work more than necessary and their free time is eliminated so that the upper classes can be idle (Coşkuner, 2014). Lafargue and Bertrand Russell’s thoughts are parallel to each other. Lafargue, in his work titled “The Right to Laziness”, criticized the institutions for glorifying overwork by saying “A strange frenzy has enveloped the working classes of the nations dominated by capitalist civilization. This madness has led to individual and social deprivation, which for two centuries has afflicted humanity which is in pain. This madness, the love of work; It is the individual’s passion for work, so extreme that it consumes the life force of his children with him. Priests, economists and moralists, instead of



opposing this heresy, sanctified work” (Lafargue, 2017). Russell, on the other hand, explained that a 4-hour study is sufficient in his book “In Praise of Idleness” saying: “If ordinary workers worked 4 hours a day, there would be enough of everything for everyone, and there would be no unemployment. In a world where no one had to work more than 4 hours a day, anyone who is interested in science would be able to deal with science without being hungry; no matter how perfect their paintings are, every painter would be able to paint without starving.” (Russell, 1992). Ivan Illich questioned the institutions of modern society and severely criticized schooling, health system and working life in his books “The Extortion of Health”, “Society Without School” and “The Right to Unemployment”.

Another person against authority and work is Henry D. Thoreau. Thoreau preferred to write his work *Walden* by secluding himself in the cottage that he built himself (Thoreau and Gandhi, 2012, s. 7). In his work, *Walking*, he objected to capitalism kneading the individual like a dough and giving it the shape it wanted by saying “I think that I would not be able to maintain my health and morale if I did not wander around in the forest, over the hills and fields, free from all worldly pursuits, at least 4 hours a day, usually more than four hours.” (Thoreau, 2014). In his book “The Philosophy of Walking”, Frederic Gros bases the success of philosophers and intellectuals in their work on their free time and their opportunity to be able to walk freely. Nietzsche, Rimbaud, Henry David Thoreau, Rousseau, Gandhi, Walter Benjamin are the free and idle personalities he mentioned in his book (Susem, 2019). For example, he mentions Rimbaud in the records of the hospital where he died: “He was born in Charleville, he was passing through Marseille ...”. On the other hand, Rousseau said, “I do nothing without walking, my study room is the countryside” (Çayırılı, 2018).

### **1.1) The Concept of Flaneur in Literature and Not Working**

It is possible to come across works with flaneur characters in both Turkish and Western literature. Ahmet Mithat Efendi’s novel *Felâtnun Bey* and Râkım Efendi is the first flaneur novel of Turkish literature because it tells about an idle character, *Felâtnun Bey* (Aslan, 2012). Bihruz Bey, in Rezaizade Mahmut Ekrem’s novel *Araba Sevdası*, is a prodigal who spends his days dressing up, traveling and trying to learn French. “After coming to Istanbul, his curiosity focused on three things: firstly, driving a car, secondly, wandering around in a fancier way than any of the European-style gentlemen, and thirdly, speaking French with barbers, shoemakers, tailors and waiters in casinos” (Ekrem, 2018). Mansur Bey in Sait Faik Abasıyanık’s novel *The Unnecessary Man* is different from the characters

of the previous novels. His tours are often in his own neighborhood, and he feels restless when he leaves his own neighborhood. Mansur Bey is a flaneur with eastern traces (Karahian, 2017). He describes the moments when he rarely left his neighborhood as follows: “Yesterday I decided to leave the neighborhood for a while. I hit Unkapanı and went to Saraçhane. Istanbul has changed quite a bit. I was surprised. I also liked it in a way: Clean asphalt, huge roads... What a beautiful thing that aqueduct was! What is it that looks like a triumphal arch from a kilometer away! Next to it is the Gazanferaga madrasa, very pretty, all white” (Abasıyanık, 1992). Based on the character of Mansur Bey, Yusuf Atılgan attributes idleness to the easterners and bohemianism to the westerners. According to him, bohemianism is a choice (Aslan, 2012). The *Aylak Adam* novel by Yusuf Atılgan emphasizes the loneliness of the individual in the face of modernization and his alienation from the society in which he lives. It tells about being idle in crowds (Aslan, 2012). In search of love to get rid of his loneliness, the protagonist C. fears that when he finds love, he will look like a “person with a package”. Because the people with packages are the people who work, shop spending the money they earn, take them home and lead an ordinary life (Süsem, 2019). The flaneur figure mentioned in Walter Benjamin also denies work and division of labor. Because his job is to wander (Canpolat, 2014). In his article, Türkmenoğlu refers to the flaneur theme in İlhan Berk’s book *Istanbul*. The book touches on poverty, the workers, the hustle and bustle of the city and daily life. In the poem, which consists of 25 pages, Berk travels to Istanbul. He reflected his observations in his poetry. Poverty reveals the unwelcoming aspects of workers and Istanbul (Türkmenoğlu, 2011). Ulrich is the protagonist of Robert Musil’s novel *The Man Without Qualities*. “Ulrich is lazy, mischievous, and meddling. Because he perceives society as a dead mask, Ulrich is the ‘Man Without Qualities’ (Musil, 2009). Ulrich is described as unqualified, but he is an intellectual when it comes to art and life and his world view. Since he is against standardization and avoids responsibility, he tries to protect himself by showing himself as unqualified (Karahian, 2017). Ivan Alexandrovich Goncharov’s *Oblomov*, on the other hand, tells about Oblomov, who spends all day lazily and rebels against capitalism by refusing to work for someone else. At the beginning of the book, Oblomov’s conversation with his friend summarises Ivan’s view of work as follows:

“But you work at home from eight to twelve, from twelve to five at the apartment, then at home again. Amazed Indeed!

(...) Sudbinski asked:

What would I do if I didn’t work?

-Is there little you would do? You would read... You would write... Said Oblomov” (Sungurlar, 2021).

## 2. Walter Benjamin, The Author of Passages

In his book “On Walter Benjamin”, Adorno provides information about Benjamin’s childhood: Benjamin’s father, who was born in Berlin, is an antique dealer and is of Jewish origin. No one knows the secret spots and place names of the city as much as he does (Adorno, 2012). Ünsal Oskay states that Benjamin does not agree with the idea that his family will get rid of Judaism by trying to emulate the German bourgeoisie. He was involved with Zionist and Marxist groups in his early youth, but he did not define himself as a Zionist (Oskay, 2000). Although Adorno did not like Benjamin’s friendship with Brecht, Benjamin was fed with ideas from both Adorno and Scholeme. Since Benjamin is fed from both sides, he was likened to Janus. Benjamin blended his thoughts by taking Marxism from Adorno, theology from Scholeme, and politics from Brechte. His distinguishing feature is that he could combine opposing thoughts in himself (Avcı, 2015). Arendt, however, explains this situation as follows: He states that Benjamin does not fit into any mold. He was very patient and meticulous, but not a scientist, he interpreted texts in his studies, but he was not a philosopher, he was related to theology but was not a theologian, he was not a translator even though he had translations (Avcı, 2015). Benjamin had financial difficulties and problems with his parents for a while. He lost his security as a result of his father cutting financial aid and reminding him that he had to work for a living. Even when he was experiencing financial difficulties, he managed to expand his library (Tayanç, 2018). With Nazis coming to power, he went to Paris in 1933 and continued his studies and wrote the work “Passages”. The work, which was modified between 1927 and 1940, could not take the final shape Benjamin wanted (Canpolat, 2014). In 1939-1940, when France started to get closer to Germany, he realized that he could not stay in Paris. He aimed to reach Spain and then to New York University, but in 1940, at the border crossing, he committed suicide by swallowing the morphia crystal that Arthur Koestler gave him to use if he was caught by the Gestapo. When Brecht heard that he had died, he said: “Finally, you came to the border that cannot be crossed / we heard, you did not stop / you found a border that could be crossed, and you did” (Oskay, 2000).

### 2.1. The Concept of Dandy, Bohemian and Flaneur

For Baudelaire, it can be said that dandy is the embodiment for bohemian and flaneur. (Süsem, 2019). In the 19th century in Europe, not the aristocrats, the nobility and the church, but the heterogeneous

“city” was the key. The actors of the city are the dandy, bohemian and flaneur described by Baudelaire in his book *The Painter of Modern Life* (Demirkıran, 2017). The starting point of dandyism is London, and every artist who has gained the appreciation of Baudelaire is a dandy for him. Despite the artist’s attitude towards crowds, dandy does not like crowds, just like an aristocrat. Brought up in debauchery, Dandy is a man who pursues happiness despite his wealth and boredom, accustomed to others considering him important, and whose profession is grace (Baudelaire, 2013). Dandy adopts the idea of art for art and supports the separation of art from social and moral elements (Süsem, 2019).

The bohemian period Baudelaire mentioned in the Bohemia section begins with the rise of romanticism after 1830. This concept has been the subject of debate between Marx and Lafargue. According to Lafargue, bohemians do not know any rules and with their rebellious attitude almost ignore the society that humiliates them. Marx, on the other hand, says that the bohemians are an extremely heterogeneous crowd: an obscure mob of thieves, vagrants, escapees, crooks, beggars, in short, the rabble. Described as the rabble, this crowd is the Flowers of Evil for Baudelaire. However, there is no place for rabble in *La Bohème* opera, which is identified with bohemian. According to Siegel, *La Bohème* is the apprenticeship period for art and literature lovers (Baudelaire, 2013). The concept of flaneur comes from the French verb “flaneur” and in German “bummeln”. It means “walking slowly and doing nothing” (Aydın, 2019). The concept of flaneur includes a masculine reference, since walking on the street in the 19th century and the beginning of the 20th century was a masculine action. If it is to be used for women, the concept of flaneuse is preferred (Erdoğan, 2020). The concept of flaneur is first encountered in Charles Baudelaire’s *Painters of Modern Life*:

“The flaneur is a city traveler. He travels across the metropolis to its farthest corners and observes all aspects of modern life with great love, extracts it and records it in his memory. He shelters in crowds, breathes in crowds, becomes enchanted with crowds. He wanders in disguise. No one notices him; he notices everyone. He is a great judge of character.” (Baudelaire, 2013).

According to Poe, the flaneur gets rid of the uneasiness he experiences in society by blending in with the crowds (Benjamin, 2011). Benjamin points out that Baudelaire’s flanerıe is much more than idleness. He discovers the city by observing, and takes pleasure in what he observes. For this reason, flaneur is defined as a “thinker-traveler” according to Oskay (Oskay, 2000). Simmel, who has studies on modernity and the city, travels like a flaneur to investigate how industrialization affects the individual in the city. “Simmel’s social type is not a stranger, an aimless vagabond who

comes today and leaves tomorrow, but one who comes today and stays tomorrow.” Homelessness, being involved in the chaos of the city and not feeling any belonging to any group are the characteristics of flaneur (Erdoğan, 2020). Baudelaire, for example, has fourteen addresses in Paris. Benjamin, in his *Passages*, said for him, “Every bed he slept on became a ‘lit hasardeux’ (bed of adventure) for him” (Benjamin, 2011).

Flaneur does not worry about time like dandy. Even in the 1840s, turtles were taken for walks in the passages. Flaneur also adopts this tortoise speed and all his time is leisure time (Baudelaire, 2013). The flaneur, who goes for a walk in the crowd, pays attention to the objects in daily life and to how people look and behave. Although the concept of semiology was not mentioned at that time, what flaneur actually did was to try to make sense of all the images he saw because, as Simmel said, the signs of the modern period require understanding (Özbek, 2000).

Benjamin is so fascinated by the passages connecting the great boulevards that he named his work “*Passages*” which he wrote for 19th Century Paris (Tayanç, 2018). In this period, in the most active shopping places of Paris, “covered promenades, the ends of which are supported by columns, were built on the edges of the big bazaar buildings, where many shops, stores and cafes are located, leaving the shops inside. These are called Arkads/Arcades” (Oskay, 2000). Most of these passages in Paris were made between the years 1822-1837. According to Benjamin, passages emerged for two reasons: First, with the increase in textile trade, passages became places where these products were exhibited. The second reason is the use of iron construction in architecture. In addition, with the increase of gas street lamps during the 3rd Napoleon period, the masses felt at home in the light (Özbek, 2000). He mentions the passages in his 1852 Paris guide as follows:

“A relatively new invention of industrial luxury, passages are glass-topped, marble-clad passages that pass through building blocks. The most elegant shops are located on both sides of these passages, which receive the light from above; so a passage of this kind is a city in itself, a small world. This world is the home of the flaneur” (Benjamin, 2011).

Paris is a different place for flaneur compared to London and Brussels. Paris is not as industrialized and monotonous as London. While London is a city where hustle and bustle and individualization begin, Paris is crowded and allows viewing like flaneur wants (Özbek, 2000). Baudelaire, who likes to be alone in the crowd, said of Brussels: “There are no shop windows here. There is nothing to see, making use of the streets is out of the question.” (Benjamin, 2011). In the eyes of the flaneur, the city is a place where you cannot get enough of watching, it’s like a land of fantasies (Baudelaire, 2013). With capitalism, when consumption

ceased to be a necessity and started to commodify things, the products displayed in the shop windows began to be presented to the visitors. Thus, Paris began to turn into a city of commodities. Those who could not buy the products in the stores were consoled by watching the commodities at fairs around the world (Aydın, 2019). World fairs trivialize the use value of goods and alienate people from themselves and others by presenting a phantasmagorical world (Benjamin, 2011). Flaneur, on the other hand, was not deceived by this fantasy and resisted the change brought about by modernization and capitalism. When he was in the crowd, he saw what they did not see, so he saved himself from alienation (Aydın, 2019). He protested the division of labor brought by capitalism and the hustle and bustle of the metropolis by adapting himself to a turtle's pace (Benjamin, 2011). Baron Haussmann, who calls himself the subversive artist, destroys and rebuilds Paris in accordance with capitalism with the task given by Napoleon III. The city, where individuals of different statuses and classes lived together, is arranged to serve the capital. Public buildings, factories, boulevards come to the fore. With the construction of shopping centers, passages are pushed into the background. The purpose of Haussmann making the boulevards so wide was to prevent the rioters from setting up barricades. The journey of the flaneur ends with the shopping centers built instead of the passages (Özbek, 2000). This time, flaneur will continue his tour by walking the whole city instead of the passages. Both situationists and Dadaists see the city as a field of experimentation and raise the flag against alienation. For example, in spite of the budget-friendly and punctual city life, random tours were organized at random times in the 1920s. Now the city itself is an object of art: Marcel Duchamp announces in 1917 that the Woolworth building in New York is a ready made object (Baudelaire, 2013).

## **2.2. The Concept of Flaneur Today and Its Possible Transformation**

Today, although the concept of flaneur is transformed with the new media tools, there are still those who act with the flaneur spirit of the 19th century. For example, Haldun Hürel, who wrote many travel books about Istanbul, tells how he traveled and made notes in one of his books as follows:

“With my own hands, I drew the pictures or the details of many works that I came across while looking for all the forgotten and abandoned neighborhoods of Istanbul, street by street. I wanted it to be like this. It was really exciting. Experiencing this pleasure in every street and before every piece of art has literally become happiness for me” (Hürel, 2015).

Evgeny Morozov tells how today's flanerier, which finds its equivalent in Haldun Hürel, has turned into cyber flanerier and how social media has killed it. He even accuses Facebook of being the Hausmann of the Internet. According to him, social media has taken away loneliness and mystery and continues to enrich advertisers by forcing us to share our every moment with everyone (Morozov, 2012).

While there was no interaction in the Web 1.0 era, social media and applications brought the interaction among individuals to the highest level with Web 2.0. Speed, customization, consumption and curiosity to show off came to the fore.

It transformed from a time when Flaneur took long walks and knew the street in the most secluded corners, to a time when he is trying to reach his destination at great speed. The speed of the metropolis combined with the Internet and resulted in a rush in our daily life (Ercan, 2012). Thus, based on Castels' concept of network societies, Muraszkievics named societies that are intertwined with technology as mobile network societies (Özel, 2013). For example, applications that allow check-ins have increased the communication of individuals with the city and other individuals. In this way, feelings and thoughts about the place (park, cafe, restaurant, exhibition, etc.) are shared with others and the information can be constantly updated.

Bauman, on the other hand, put forward the concept of fluid surveillance and argues that the applications that make our lives easier are not that innocent. He emphasizes that scopophilia (desire to be seen) in individuals has reached alarming levels and it has come to cause ontological problems like if individuals are not followed or recorded, they will not exist (Bauman & Lyon, 2013, s. 142, 144-145). Debord, on the other hand, criticizes that the show is presented as a positive behavior with the sentence "What appears is good, what is good appears" (Debord, 2010). Netchitailova defines Facebook users as empathetic workers in her study. Because the Facebook user is exploited while having fun. On Facebook, which we can call a showroom, our life turns into a commodity. On our page are the things we buy, the places we visit and the things we consume (2018). Fuchs put it more sternly, "Google is the ultimate economic surveillance and user exploitation machine. It instrumentalizes all users and all data for investment profits" (Fuchs, 2018).

All experiences, trips, photos and comments that take place under the supervision of companies such as Facebook and Google are constantly recorded. It has become almost impossible to individually explore the city like the flaneur in the 19th century. For this reason, Conor McGarrigle



writes in his article “Forget The Flaneur” that new communication technologies have killed the flaneur (Lavarone, 2019).

With the widespread informatics, the media has become a structure that is produced, transformed, constantly updated, shared and integrated with the city, rather than being just a consumed tool as it used to be (Kut, 2013). Therefore, the act of navigating the networked city will offer a multi-layered experience with augmented reality and the metaverse, which is expected to take place in the future. Based on McLuhan, the tool is the extension of the human being, and the network system is the extension of our nervous system. Technology, which is an extension of human, also affects human relations (Altay, 2005). Smartphones, Google glasses and applications used by today’s travelers to experience the city can also be considered as extensions. The space that Müller defines as the “immersion” stage is cyberspace and is mentioned for the first time in Gibson’s *Neuromancer* book (Lavarone, 2019). According to Gibson, “if cyberspace is where people go, hybrid space is where people are. Our grandchildren will find it strange that we distinguish between virtual and real” (Tokgöz, 2017). Augmented reality, on the other hand, is a structure that contains both real and digital elements, offers a 3-dimensional experience and allows real-time interaction (Kut, 2019). The new Google Glass with an artificial intelligence engine can be quite functional in the city browsing experience.

New browsing experiences in the network society are criticized by some researchers for serving big data. On the other hand, the traces left by the travelers in the city can serve as a guide for those who will visit after them. While the 19th century flaneur was disturbed by the rapid transformation of the city, will his service to companies that collect data today not distract him from the flaneur spirit? For this reason, Rober Luke introduced the concept of “phoner” (Lavarone, 2019).

Neal Stephenson, the author of *Snowcrash* (Parasite), used the concept of metaverse for the first time in this book and explained his reasoning as follows: “The words avatar and metaverse are my inventions; These are the words I found because I was convinced that existing words (such as virtual reality) were insufficient” (Stephenson, 2016). The concept of metaverse consists of the words meta (beyond) and universe. Some researchers say that humanity, accustomed to working online with the Covid 19 pandemic, will easily adapt to the metaverse, which is the upper stage of the Internet (Kuş, 2021). Although the concept of the metaverse has only just begun to be discussed, it was explained in detail in the 1992 book *Snow Crash* with that same name. People living with their avatars in the multiverse are mentioned as follows: “Your avatar could look any way you wanted, depending on the limitations of your equipment. If you were



ugly, you could make your avatar beautiful. If you just got out of bed, your avatar could appear in beautiful clothes and make-up” (Stephenson, 2016). In addition, games such as Second Life and SimCity can be considered as prototypes of the metaverse.

You can meet your avatars in a cafe with Metaverse tools (Oculus VR) ([www.virtualedge.org/metaverse/](http://www.virtualedge.org/metaverse/)). Meetings with Zoom will thus be able to be held through avatars (digital twin) and VR glasses, which will offer the “immersion phase”. This will change the way of education, health and work. The act of wandering will also be affected. Instead of visiting virtual museums, it may seem more attractive to feel like you are walking inside a museum or exhibition hall with VR glasses (real time and 3D). It will be possible to get information about a historical building while standing in front of the building. For example it will be possible to see the building and its surroundings in the 18th century, to see the daily life (people, clothes, etc.) with the metaverse. The interaction of avatars entering the Metaverse with other avatars will increase information and sharing, while serving big data, just like in web 2.0. The fact that companies such as Facebook, Roblox and Microsoft are investing more and more in the metaverse raises concerns about how personal data will be processed. How will the data about sightseeing, shopping, etc. be used? Has the legal framework been established? Such issues have not yet become clear (Kuş, 2021).

Does augmented reality present us reality or does it present a simulation? The movie Ready Player One (2018), directed by Spielberg, tells about the people who live as actors (acting with their digital twins) in the play Oasis.

The world of Metaverse, which offers a 3D and real-time experience, is actually a simulation. Baudrillard takes this situation “to a process where the real disappears and it is replaced by simulacra. In this way, the reproduction of reality is ensured” (Öker, 2005).

### 3. Methodology

**The aim of the study:** The aim of the study, which deals with the transformation of the flaneur character in the modern society in the network society and the changes in the way the flaneur communicates with the city, is to determine how the flaneur character’s dynamics of integration with the city in the fluid network society change through a mobile application. The research sought answers to the following questions:

1) How did the net flaneur’s experiences change compared to the 19th century flaneur?

2) How have innovations in communication technologies changed the net flaneur's experience of the city?

3) What are the effects of social media and applications on the net flaneur?

4) How is the net flaneur integrated with the consumer society?

**Method of Study:** In the research, semi-structured interview method was used. Semi-structured interview method was preferred as it allows the participant to go out of the question form determined by the researcher. Thus, new questions could be asked by going in-depth on the issues that need to be addressed. "Qualitative data collection over the Internet has advantages in terms of cost and time efficiency, as it reduces transportation costs (Creswell, 2021). The interview was carried out via Zoom, as the application designers are located in different cities. There was no data loss as it could be recorded simultaneously during the interview.

**The Universe of the Research:** All designers of the applications designed for travel purposes in Turkey constitute the universe of the research.

**Sample of the Research:** All applications designed for travel purposes in Turkey were examined and Flaneur App was selected by random sampling. In the first place, the designers were contacted via e-mail.

**Scope and Limitations:** The interview, which was done via Zoom, was held on 21.12.2021 at the specified time. The interview lasted for a total of 1 hour, in two separate parts.

**Analysis of Data:** The purpose of descriptive analysis is to transfer the data collected as a result of the interview to the reader by organizing and interpreting. While transferring the data, direct quotations are included. In the findings stage, it is interpreted by establishing a relation (Baltacı, 2009). The data obtained after the interview was analyzed, transcribed and interpreted using direct quotations.

**Validity and Reliability:** Although there are different methods to measure validity and reliability in quantitative research, it is very difficult to obtain a definitive validity and reliability output in qualitative research (Baltacı, 2019). Accordingly, since long-term interaction is required to ensure credibility, a 1-hour interview was held with the participants in 2 parts. In order to provide participant checking, the participants were expected to state what they wanted to add at the end of the interview questions. In addition, opinions were received from faculty members who specialize in research methods.

Ethics committee approval for this study was obtained with the approval of the Social and Human Sciences Scientific Research and Publication Ethics Committee of Uşak University, with the decision numbered 52231 on 10.12.2021.

## Findings

1) First of all, the participants were asked to introduce the Flaneur APP team and the following answers were received:

M. T.: “I did a double major in Architecture and Interior Architecture at Istanbul Bilgi University. I had a working adventure in Singapore for about 6 months. Then I returned to Turkey and did architectural work”.

P. A: “I studied architecture at Bilgi University. At a time when we were actively doing architecture, this was actually a project we had been thinking about since school. The concept of flaneur was used in our art history and architecture classes. While we are doing architecture, we are also developing the application with our software developers and 3 fellow architects including me”.

M.T: “We actually have a selective team of architects. Architects, interior designers, people with a design language, interested in photography. We worked with a friend who prepared the interfaces of user experience design. Another friend of ours did our software work. We aim to establish and develop a community of architects and software developers”.

2) Do you have a preference for the language of the Flaneur APP?

P.A: “Our goal is to reach the entire user base. This goes through all the spaces they use and appeal to their tastes. We publish our application in both Turkish and English. When foreigners come, we want them to be able to freely browse our application”.

3) Did you choose the name Flaneur on purpose? How was the name of the application born? And why did you decide to design this app?

M.T: “We didn’t actually set out to make an application called flaneur. What we do is to reveal how architecture, interior architecture and design elements are seen by people in real life. In the new era, we have determined that the product of people’s perceptions is photography, video and social media. We said, ‘Can we make all these design facts, the concept of space and city into a selection? Can we filter them? While flanerie in the old times was the action of high class people and those with money, there is a reality in the new era: No matter how bad people’s lives are, everyone is trying to appear happy on the platform called social media. We believe in the validity of the concept of the flaneur that shows

and influences in the new era, instead of the concept of flaneur that looks down on people in the old period”.

P.A: “We chose the word flaneur to be international. Our first codename was Instapoints, a combination of Instagram and points. Like points to be put directly on Instagram with a commercial concern. We abstained because Intstagram patented the Insta acronym. However, the name Instapoints still belongs to us. We remembered the word flaneur from the lessons of İhsan Bilgin and İskender Savaşır”.

**4) How many editors are there in your team?**

P.A: “When we first started, we were a team of three. The three of us were photographing the places. But since it would be very difficult to take photos, collect, edit and write the tags while dealing with everything, we developed another business model. We created an army of volunteers consisting of architecture students with a certain perspective and knowledge of architecture. We advertised on some pages on social media on Instagram that we were looking for flaneurs and local editors. We will launch not only in Istanbul, but also in ten cities in the first place, and then we aim to launch in all 81 provinces. We have local editors and architecture students living here. We currently have 15 editors. Our editors work in cities such as Adana, Antalya, Bolu, Mersin, Eskişehir, Bursa and İzmir”.

**5) Could you tell us about the applications made before the Flaneur APP? How and when did your process of creating the application begin?**

M. T: “Trials have been made about such applications before. We started this business in a period of 2 years. The pandemic period has extended the process a bit. In the meantime, we released our demo version. Our starting point is the concept of flanerie which we know from the history of architecture course”.

P. A: “Our motto is “be a flaneur”. The flaneur spirit is in all of us”.

**6) Who is your target audience?**

P.A: “Even though we want to reach everyone, venues do not welcome people outside of their customer profile. If it is a very luxurious place, they do not want someone who has no money to come or unnecessary crowds. That’s why we work with a filtration system”.

**7) What are the categories within the app? What will the interface of the application be like?**

P.A: “This is now the behavior of exploring a city. The motivation to explore has also increased a lot. People now want to buy experience. Eating a good meal, going to a good cafe, passing a good street and

photographing and showing it... We have so many categories in the app. Such as cafe, restaurant, history, nature, shopping, street. art galleries etc. The app has everything you can think of”.

**8) How did you plan your workflow? How do you create content?**

M.T: “We work based on location. You can search through filters, categories, what’s near me. A second filtering can be applied by first searching for what’s near me. You can also have a look if you want to randomly explore what’s around. We made ranking in the selection phase. First, of course, we started with the tourist areas (in demo phase). In Istanbul, we divided the districts into three levels. We are now at level 2. We shot the cafes in Bahçeşehir. A new world has been created outside of Istanbul, we were surprised. I am a native of Istanbul, born and raised, but while I was looking into this application, I realized that there are districts that I have not been to. The feeling of discovery never ends. Sometimes we can’t see what’s right in front of our eyes”.

**9) Are the contents (photos, videos, etc.) created through an architectural point of view?**

M.T: “When we go to venues, we have a goal: we try to capture the best photo that gives the best photo, the final output of the new era flaneur. We were very selective at first. We thought that there would be places that offered a good atmosphere, we were looking at it from the perspective of architects. Then we decided that we should appeal to everyone. Everyone is a flaneur in their own way”.

**10) According to which criteria did you categorize the places in the districts (for example, in Istanbul)?**

P.A: “We also have main categories for those who don’t want to filter: History, shopping, restaurant, cafe. Apart from this, in our filtering system, for example, you go to Bahçeşehir and you do not know any place, but you want to eat fish, you want a spacious place or you prefer a colorful – lively place. By entering these filters, the app can take you directly to the place you are looking for without any information pollution or confusion. Thus, if a tourist who comes to Istanbul wants to eat fish in the Bosphorus, they can reach the places they are looking for by entering the “view, terrace, fish” filters in the hint section.”

**11) Will special routes be designed for sightseeing in the city?**

P.A: “There will be routes of famous people (cooks, writers, artists) apart from our editors. For example, the favorite art galleries route of a famous artist in the city.. Or the routes created for wine lovers.. We will have a homepage flow. There, for example, you will be able to find the

wine restaurants route of the famous journalist in Istanbul. Or like Ahmet Güneştekin's favorite art galleries in Istanbul. Popular ones from these lists will come to the fore after a while. You will be able to discover the favorite routes of not only famous people but also of your friends".

M.T: "We have another goal: Of course, our work has a commercial concern. After a while, we can combine routes with tourism".

**12) Could you explain how the venue check-ins will be done?**

M.T: "Everyone is a user and you can check in at the venues. There were applications such as Swarm and Foursquare. We want people to check in with a photo through our venues here. Photographs will remain on the page of that venue for 24 hours. Users will earn points from this action. In our new version, we have a motto: "Travel and earn". By collecting these points, users will gain discounts at the cafes and restaurants we have contracted with. We thought it would be effective in encouraging users to use the application".

**13) How does the flaneurbuddy system work?**

M.T: "We have a system that we call the flaneur body. You open events through our indoor venues. For example, you want to go to a gallery or a museum, but you have no friends. For example, you write that I will drink coffee at cafe x and I am looking for 2 friends. We have filters for what you can talk about in the application. For example, literature, astrology. The app tags these under the event so that people with the same mentality can come together".

P.A: "There will be a hierarchy of opening events with the points you collect. For example, you are going to Topkapı Palace and you want to take a friend with you. In order to open this event, if you write like "Pınar is going to Topkapı Palace, who is available on Wednesday, looking for a flaneur friend", for example, if this is an event with 10 points, for example, opening a larger workshop is an event with 50 points".

**14) Can you explain your long-term goals for the Flaneur APP?**

P.A: "Our long-term goal is to expand abroad. By 2022, we want to implement this in big touristic cities".

## Conclusion

One of the tools that individuals frequently use today is applications. Flaneur APP, which was established to contribute to the act of navigating in the city, was designed by three architects. The goal of the designers is to be a guide to the users, to be able to take interesting photos and present selected spaces for them. The Flaneur APP team explains their problem, namely why they developed this app: “The biggest problem when you want to travel, have fun outside or explore the city is the lack of a guide who can understand your wishes and feelings and respond quickly and correctly”. This sentence literally describes the network flaneur because speed is important for today’s flaneur. For example, the most beautiful travel photo should be taken quickly and presented to others as soon as possible! When the designers were asked about the language of the application, they stated that they preferred both English and Turkish. Since the aim in social media is to increase the target audience as much as possible, choosing a foreign language can be accepted as a requirement of the network society.

M.T “While flaneur was the action of high class people and those with money in the old times, there is a reality in the new era: No matter how bad people’s lives are, everyone is trying to appear happy on the platform called social media. We believe in the validity of the concept of the flaneur that shows and influences in the new era, instead of the concept of flaneur that looks down on people like in the old period”. The concepts of “showing, influencing, influencing” that are stated in this expression are a short definition of the new era network flaneur. While the 19th century flaneur establishes an individual connection with the city, today’s flaneur establishes a dynamic connection with the city, shares his experience and influences those who visit the city after him. Rather than being alone in the crowd, he acts collectively with the crowd.

When the participants were asked who their target audience was, they answered as women between the ages of 15-35 using Instagram, those who like to travel and tourists, businesses and users who want to increase their popularity. Instagram is the first social media medium that comes to mind when “showing and influencing” is mentioned because Instagram is one of the fantasies in which meta fetishism is exhibited. In addition, many travel companies and travel lovers can help certain places to be popular places by photographing the places they visit and see on Instagram. The 19th century flaneur, on the other hand, is very reticent in sharing his experiences. For example, while the 19th century flaneur might spend hours in front of a historical building, today’s flaneur will want to take a quick photograph and share it because the power that motivates the latter

is to be liked at the same time. The former, on the other hand, finds the source of motivation only in himself.

When the participants were asked what the categories in the application were, they stated that they wanted to buy experiences (such as a good meal, walking through a nice street). In today's world, exploring the city with a guide or application seems more essential than exploring alone. The 19th century flaneur, on the other hand, preferred to travel randomly and at a tortoise's pace, and to explore even the most remote corners by himself.

When asked about the flow and interface of the Flaneur APP, they stated that they work based on location and use various filters. With the connection of individuals and the city through the network, options such as "what's near me" and "what's around" are tabs that make it easier for users to navigate.

To the question of how the content is created, M.T said, "We are trying to capture the best photo that will give the final output of the new era flanerie," and emphasized how much importance individuals attach to photography and video while choosing a venue. In particular, Instagram has become a medium where people share the colorful and trendy streets they go to (for example, the Balat district of Istanbul), carefully decorated cafes or photos of historical places. Hundreds of people are getting in line to take and share a photo at the same spot, thanks to a photo taken by one person on the colorful stairs of Balat. Therefore, the new period flaneur that M.T mentioned has turned into an action where individuals share their photos while they travel. Photographable areas are discovered by individuals after being shared by travel companies, travelers, and editors of travel pages on social media.

For example, when asked according to which criteria the spaces in Istanbul are categorized, it was stated that different categories such as history, shopping, restaurant, cafe, street were created. What is remarkable here is the hint section in the filtering system. With the hint section, you can find the place you want to visit. The 19th century flaneur, however, would rather go on an adventure and scrutinize whatever came his way, rather than find his destination easily.

Creating special routes related to the city in the application and allowing newcomers to follow these routes is a helpful element to explore the city. Earning points by checking in at destinations is a strategy to popularize the application.

Many people do research on social media for the places they will go for the first time, and receive information such as "what to eat, what



to wear, where to go” on the travel pages. The Flaneurbuddy section is a system that helps those who do not want to travel alone and allows those who have similar interests to meet.

Innovations in communication technologies have begun to gradually change the bond that individuals establish with the city. The communication of individuals with each other and with the city has started to intertwine with web 3.0. In the new society model called network society, in Bauman’s words, each of us is an internet connection. While this situation is welcomed by some researchers, it is criticized by other researchers for the fact that personal data is out there and everyone has an internet connection, so the distinction between public and private spheres is almost non-existent. In addition, the concept that Marx defined as commodity fetishism today finds its counterpart in social media in different ways. Considering the opposition of the 19th century flaneur to the system (against modern society, capitalism, commodification, division of labor, speed, consumption), today’s flaneur does not have the strength to resist under the supervision of capital and the state because the network flaneur is now an internet connection that serves big data. He leaves traces in the city through the means of communication he uses. The 19th century flaneur is an intellectual who pays attention to those around him and to those walking around the city. For this reason, the concept of flaneur was transferred to Turkish by Ünsal Oskay as a thinker-traveler. Defined as homeless and without a sense of belonging, the flaneur is a free-spirited person, against being “with package” in Yusuf Atılgan’s words.

Today, shopping malls and social media have replaced the passages in the past. Both offer individuals a world of fantasy. Morozov accuses Facebook of being the Haussmann of the internet, because social media has taken away from individuals the chance to act in crowds without appearing like a flaneur, by constantly saying “share your experiences”. Social media puts the emphasis on appearing and showing, unlike 19th century flanerie. Behind appearing and showing, meta fetishism is hidden: checking in at a famous restaurant in the city and sharing filtered photos with the most beautiful clothes, etc. In the future, consumption is expected to continue by buying clothes etc. for our digital twins or metahumans in the metaverse. For this reason, many companies have started to take place in the metaverse.

Future studies can be compared with different social media platforms especially with the social media accounts of travel companies. In addition, interviews can be made with individuals who have experienced the metaverse in the future.

## REFERENCES

- (...). (2022, January 6). What is the metaverse? Is the future of the web the metaverse? Retrieved from <http://www.virtualedge.org/metaverse>
- Abasıyanık, S. F. (1992). *Şahmerdan – lüzumsuz adam*. Ankara: Bilgi Yayınevi.
- Adorno, T. W. (2012). *Walter Benjamin üzerine* (D. Muradoğlu, Çev.). İstanbul: Yapı Kredi Yayınları.
- Altay, D. (2015). Küresel köyün medyatik mimarı Marshall McLuhan, N. Rigel (Yay. Haz.). *Kadife karanlık kitabı* içinde (pp. 9-74). İstanbul: Su Yayınları.
- Aslan, C. (2012). İmkânsızlığa rövaşata: Yersizyurtsuzluğun tabutunda flanör, H. Köse (Ed.). *Flanör Düşünce kitabı* içinde, (pp. 424-456). İstanbul: Ayrıntı Yayınları.
- Avcı, A. (2015). Ünsal Oskay'ın Walter Benjamin üzerine çalışmaları. *Marmara İletişim Dergisi*, 23, 13-36.  
<http://dx.doi.org/10.17829/midr.20152316040>.
- Aydın, E. (2019). *Walter Benjamin'de flaneur kavramı*. (Yüksek Lisans Tezi). İzmir Kâtip Çelebi Üniversitesi Sosyal Bilimler Enstitüsü, İzmir.
- Baltacı, A. (2019). Nitel araştırma süreci: Nitel bir araştırma nasıl yapılır?, *Ahi Evran Üniversitesi Sosyal Bilimler Enstitüsü Dergisi*, 5(2), 368-388.  
<http://dx.doi.org/10.31592/aeusbed.598299>.
- Baudelaire, C. (2013). *Modern hayatın ressamı* (A. Berktaş, Çev.). İstanbul: İletişim Yayınları.
- Bauman, Z. ve Lyon, D. (2016). *Akışkan gözetim* (E. Yılmaz, Çev.). İstanbul: Ayrıntı Yayınları.
- Benjamin, W. (2011) *Pasajlar* (A. Cemal, Çev.). İstanbul: Yapı Kredi Yayınları.
- Canpolat, E. (2014). Walter Benjamin'de yöntem, *Moment Dergi*, 1(2), 270-295.  
<http://dx.doi.org/10.17572/mj2014.2.270295>.
- Coşkun, A. (2014). *Türk sinemasında aylıklık*. (Yüksek Lisans Tezi). Maltepe Üniversitesi Sosyal Bilimler Enstitüsü, İstanbul.
- Creswell, J. W. (2021). *Nitel araştırma yöntemleri* (M. Bütün, S. Demir, Çev.). Ankara: Siyasal Kitabevi.
- Çallı, D. (2015). Uluslararası seyahatlerin tarihi gelişimi ve son seyahat trendleri doğrultusunda Türkiye'nin konumu, *Turizm ve Araştırma Dergisi*, 4(1), 4-28. Erişim adresi: <http://www.dergipark.org.tr/tr/pub/turar/issue/39646/469126/>
- Çayırılı, K. (2018). Yürümeseydim yazamazdım yürümenin diğer tarihi, *Sabit Fikir Dergisi*, 21-25. Erişim adresi: <http://www.sabitfikir.com/dosyalar/yurumeseydim-yazamazdim-yurumenin-diger-tarihi>

- Debord, G. (2010). *Gösteri toplumu* (A. Ekmekçi, O. Taşkent, Çev.). İstanbul: Ayrıntı Yayınları.
- Demirkıran, Y. (2017). 19. yüzyıl erken modern kent karakteri olarak Charles Baudelaire'in flaneur kavramının yeni medyadaki izdüşümü, *Sanat ve Toplum Dergisi*, 105-121. Erişim adresi: [http:// www.dergipark.org.tr/tr/pub/sanatvetasarim/issue/33313/370735](http://www.dergipark.org.tr/pub/sanatvetasarim/issue/33313/370735)
- Ekrem, R. M. (2018). *Araba sevdası*. İstanbul: Anonim Yayıncılık.
- Ercan, C. (2012). Odysseus ve yolculuk mitosu. H. Köse (Ed.), *Flanör Düşünce kitabı* içinde, (pp. 321 – 263). İstanbul: Ayrıntı Yayınları.
- Erdoğan, R. (2020). *Flanör & flanöz – modern çağın gözlemci seyyahları*. İstanbul: Çizgi Kitabevi.
- Fuchs, C. (2018). Google kapitalizmi. F. Aydoğan (Ed.), *Yeni medya kuramları kitabı* içinde, (pp. 71-83). İstanbul: Der Yayınları.
- Giddens, A. ve Sutton, P. (2020). *Sosyolojide temel kavramlar*, (A. Esgin, Çev.). Ankara: Phoenix Yayınları.
- Hürel, H. (2015). *İstanbul'u geziyorum gözlerim açık*. İstanbul: Kapı Yayınları.
- Karahan, E. (2017). Flaneur kavramı üzerinden niteliksiz adam ve lüzumsuz adamın değerlendirilmesi. *Gaiadergi*, Erişim adresi: <http://www.gaiadergi.com/flaneur-kavrami-uzerinden-niteliksiz-adam-luzumsuz-adamin-degerlendirilmesi/>
- Keleş, R. (1993). *Kentleşme politikası*. Ankara: İmge Kitabevi.
- Kuş, O. (2021) Metaverse: dijital büyük patlamada fırsatlar ve endişelere yönelik algılar. *Intermedia International e-journal*, 8(15), 245-266.
- Kut, S. (2013). *Sibertektonik mekân*. (Doktora Tezi). İstanbul Teknik Üniversitesi Fen Bilimleri Enstitüsü, İstanbul.
- Lafargue, P. (2017). *Tembellik hakkı* (İ. Montanari, Çev.). İstanbul: İthaki Yayınları.
- Lavarone, A. (2019). *Ağ toplumunda kent gezgini*. (Yüksek Lisans Tezi). İstanbul Teknik Üniversitesi Fen Bilimleri Enstitüsü, İstanbul.
- Morozov, E. (2012, May 2). The Death of the Cyberflaneur. *New York Times*. Erişim adresi: <http://www.nytimes.com/2012/02/05/opinion/sunday/the-death-of-the-cyberflaneur.html>
- Musil, R. (2009). *Niteliksiz adam* (A. Cemal, Çev.). İstanbul: Yapı Kredi Yayınları.
- Netchitailova, E. (2018). Flaneur, aylak ve empatik işçi. F. Aydoğan (Ed.), *Yeni Medya Kuramları kitabı* içinde (pp. 1-22). İstanbul: Der Yayınları
- Oskay, Ü. (2000). *Tek kişilik haçlı seferleri*. İstanbul: İnkılap Yayınevi.
- Öker, Z. (2015). Kurgusal dünyanın gölgesinde bir unutkan: Jean Baudrillard. N. Rigel (Yay. Haz.), *Kadife karanlık kitabı* içinde (pp. 193-260). İstanbul: Su Yayınları

Özbek, M. (2000). Walter Benjamin okumak – 3, *Ankara Üniversitesi Siyasal Bilgiler Fakültesi Dergisi*, 55(4), 83-110.

[http://dx.doi.org/10.1501/SBFder\\_0000001928](http://dx.doi.org/10.1501/SBFder_0000001928)

Özel, S. (2013). İletişimde mobilizasyon ve mobil hayatların bilimsel çalışmalarındaki inşası. M. Demir (Ed.), *Yeni medya üzerine kitabı* içinde (pp. 217 – 254). Konya: Literatürk Yayınları.

Russell, B. (1992). *Aylaklığa övgü* (M. Ergin, Çev.). İstanbul: Cem Yayınevi.

Stephenson, N. (2016). *Parazit*, (S. Hacıoğlu, Çev.). İstanbul: Altıkırkbeş Yayınları.

Sungurlar, I. (2021). *Bir sıkıntı mekânı olarak eve ilişkin fenomenolojik bir yaklaşım*. (Doktora Tezi). Işık Üniversitesi Sosyal Bilimler Enstitüsü, İstanbul.

Süsem, T. (2019). *Fotoğrafta kamu eleştirisi: Beton*. (Yüksek Lisans Tezi). Marmara Üniversitesi Güzel Sanatlar Enstitüsü, İstanbul.

Tayanç, T. (2018). Walter Benjamin: 1892-194). T. Tayanç (Haz. ve Çev.). İ. Yıldız, B. Erdağı (Ed.), *Walter Benjamin kitabı – seçme yazılar kitabı* içinde, (pp. 15-78). Ankara: Dipnot Yayınları.

Tekeli, İ. (2011). Kent, kentli hakları, kentleşme ve kentsel dönüşüm. İstanbul: Tarih Vakfı Yurt Yayınları.

Thoreau, H. D. (2014). *Sivil itaatsizlik-yürümek* (A. Örköp, Çev.). İstanbul: Zeplin Yayınları.

Thoreau, H. D. ve Gandhi, M. K. (2012). *Sivil itaatsizlik ve pasif direniş* (H. Arslan ve Fatma Ünsal, Çev.). Ankara: Vadi Yayınları.

Tokgöz, C. (2019). Konum tabanlı mobil oyunlar ve mekân algısı: Ingress üzerine etnografik bir araştırma. *İlef Dergisi*, 4(2), 7-36.

Türkmenoğlu, S. (2011). İlhan Berk'in İstanbul kitabında flaneur. *Turkish Studies*, 6(3), 1769-1781.

Weber, M. (1999). *Protestan ahlakı ve kapitalizmin ruhu* (Z. Gürata, Çev.). Ankara: Ayraç Yayınevi.

“

## Chapter 2

### **MIGRATION PERCEPTION IN LOCAL ADMINISTRATIONS: A CASE OF ÇANAKKALE MUNICIPALITY<sup>1</sup>**

*Alper BİLGİLİ<sup>2</sup>*

*Fatma HIRLAK<sup>3</sup>*

”

---

1 This study was presented at the 6th National Local Governments “Resilient Cities” Symposium organized in cooperation with the Union of Municipalities of Turkey, the Presidency Local Government Policies Board and Ankara University between 25-27 October 2021.

2 Assis. Assoc. Dr, Çanakkale Onsekiz Mart University, Biga Faculty of Economics and Administrative Sciences, Department of Public Administration, bilgili@comu.edu.tr, orcid: 0000-0003-0417-5070

3 Doctoral Student, Çanakkale Onsekiz Mart University, Graduate Institute, Doctoral Program of Public Administration Department, fatmahirlak06@gmail.com, orcid: 0000-0003-0102-8198

## INTRODUCTION

Since the beginning of humanity, migration has been considered not only as a location change but also as a social and cultural movement. Residential areas showed up as the nomads started being engaged in agriculture. Together with the development of the consciousness of living together among the humans adopting a sedentary life, concepts such as homeland started to develop. As a result of the concepts, which we call commitment to the place of settlement, people had to leave the places where they have lived. This change of location is called migration.

The main reason for the concept of migration is peoples' desire to have a better life. For this reason, leaving the places where they live in, individuals go to locations, where they can have higher standards. Although individuals' reasons for migrating vary, the objective is generally the same. However, the concept of international migration that is called to have multiple causes, varieties, and outcomes, together with the globalization, emerged in the literature. This concept, which has brought many confusions with it, necessitated the states to develop effective public policies solely and together. At this point, it is important to involve the local governments, non-governmental organizations, and private sector in order to create transparent policies involving accountability. Moreover, one of the main factors influencing the policies developed in the recent period is the media. It seems to be important to cooperate with the media while preparing the policies because the policies developed by excluding the media would not be accepted by the people and would cause the people to be caught by the negative thoughts about migration and migrants. Here, the perception created among individuals towards the concepts such as migration or migrants is very important. Specifically, the perception of migration becomes more important for the units living in communication with migrated individuals.

Thus, the research problem here is to determine the perceptions of local governments in Turkey about the migration. Using the metaphor method, this study aims to determine the prominent factors regarding the perceptions of individuals, who work in the Social Support Services Department of Çanakkale Municipality, regarding the migration. Considering the research problem and objective, it was aimed to find the answer to the following questions about the persons working in the aforementioned department: 1) What are the factors coming forefront in their perception about the migration, and 2) Is there a difference between women and men working in the Social Support Services Department of Çanakkale Municipality.

The study consists of three sections. The first section includes concepts related with migration. Then, it discusses the relationship between local governments and migration. In the second section, it is aimed to provide information about the objective, importance, and scope of the study, the questions created about the research problem, the pattern used in the research, data collection method, and analysis method. In the final section, considering the interviews performed with 10 individuals, the results achieved about which factors the participants brought forward about the concept of migration and if there was a difference between perceptions of women and men participants.

## **1. CONCEPTUAL FRAMEWORK**

The concept of migration is discussed in this section. Then, the relationship of migration concept with local governments is explained.

### **1.1. Migration**

Migration is defined as the individuals or communities changing location because of economic, social, or political reasons; it can be discussed in two different categories: one category is the internal migration, in which individuals change their locations within the border of country in which they live, and the second one is the international migration, in which individuals migrate outside the country in which they live (TDK; Çelebi, 2020: 401). However, the concept of migration cannot be defined only as a change of location because both locations receiving and sending the migration have social, cultural, and economic transformation (Castles and Miller, 2008: 11; Okolski, 1999: 141). Especially as a result of the increase in poverty and income inequality experienced after the globalization deepening the socioeconomic inequality, the migration movements between and within the countries intensify and the resulting concept of international migration causes qualitative and quantitative changes in migration (Castles, 2002: 1149-1157; Karataş and Ayyıldız, 2021: 475; Deniz, 2014: 177). These events cause diversifications in ethnical origins and geographical scope among migrants and increasing migration events bring many problems with them. These include problems related with the safety of a country, especially the safety of citizens, because of the illegal migration and the migration movements caused by reasons such as war, as well as global problems such as cultural conflicts and high levels of deaths (De Haas et al., 2019: 888; Demirhan and Aslan, 2015: 29; Öner, 2018: 14).

Besides the safety problems, it is also important which status the migrants have in the receiving country and how they are received by the local society because they create a high level of pressure on the labor

market and they cannot benefit the public services sufficiently. It seems important for both protecting the rights of migrating individuals and preventing the potential cultural conflicts because migrants might be subjected to political, economic, and social discrimination (Demirhan and Aslan, 2015: 29; Sam, 2018: 163-164). In this parallel, in the receiving country, the migrating individuals might be defined with terms such as migrant, refugee, and asylum-seekers (Demirhan and Aslan, 2015: 25). The concept of migrant is used for the individuals changing their location with their free will in order to improve their own financial and social conditions. However, the terms asylee and refugee are used for individuals changing their locations having a risk of death in the country, of which they are citizens, because of their race, religion, nationality, their political opinions, or affiliation to a specific social group. Refugees have a legally specified status, whereas asylum-seekers are those having no such status but provided with a temporary protection status (Migration Terms Glossary).

At this point, it can be seen that the concept of migration might affect individuals, societies, and states differently. Intense migration movements occurring in recent period because of internal conflicts and other problems in the Middle East and particularly the Syrian Migration Crisis are among the most intense migration waves, which have been rarely seen throughout the history, in terms of amplitude and time. These migration movements influenced the nearby countries, especially Türkiye, and the European countries and these countries have had and are still having many economic, political, legal, and social problems (Zanker, 2008: 5; Aydemir and Şahin, 2018: 127; Keskin and Yanarışik, 2021: 57). For instance, the murder of a Turkish individual by a Syrian group in the last August created a significant tension and Syrians faced remarkable reaction. Businesses and houses of many Syrians were destroyed, and protests were held. People stated that they did not want Syrians in their neighborhoods (BBC News, 2021). It can be seen that such events limit the chance of living together in harmony for migrants and locals (Sargut, 2001: 91). It seems possible to eliminate the problems through an effective migration governance. At this point, local governments, which are the units closest to the public, have important responsibilities.

## **1.2. Local Governments and Migration**

Today's highly centralized national governments neither operate locally nor think globally. Hence, it can be seen that decentralization and regional development became the urgent needs of all the countries (Capra, 2012: 472-473) because the incredible penetration and advancement of communication and transportation technology brought a new life and



organization style exceeding the national state borders in today's world. It reduced the effectiveness of national states, which have a strong central structure, and resulted in more local structures (Çevik, 2012: 87). Similarly, the social changes and transformations showed that government evolved in a way requiring the involvement of local administrations in every field of government because, through the steps they take, the local administrations provide more pragmatic and effective solutions in comparison to the central administrations. In this parallel, it is necessary for the local administrations to play an effective role in solving the social and cultural problems increasing with a further increase in the international migration movements (Rajca, 2020: 169; Daoudov, 2015: 4) because the local administrations undertake the responsibility of governing the cities, in which the social integration is achieved, as well as managing the differences and the adaption of new-coming individuals to the local society (Ray, 2003). At this point, the migration policies developed by the local administrations seem to be important.

## **2. RESEARCH METHOD**

This section specifies which problem this research is based on and which objective it has. Moreover, the importance, scope, pattern, and limitations of this study and how the data were achieved are explained, as well as the analysis and reporting processes.

### **2.1. Problem and Research Questions**

The research problem was set to be “What are the perceptions of local administrations in Türkiye about migration?”. Regarding the research problem, it was aimed to find the answer to the following questions about the persons working in the aforementioned department: 1) What are the factors coming forefront in their perception of the migration, and 2) Is there a difference between women and men working in the Social Support Services Department of Çanakkale Municipality.

### **2.2. Objective and Importance**

The present study using the metaphor method aims to determine the prominent factors regarding the perceptions of individuals, who work in the Social Support Services Department of Çanakkale Municipality, about migration. This study is important since it might create a change in the perceptions of people, who have in-person communication with migrants, about migration.

### **2.3. Scope and Limitation**

The scope of this study includes provincial special administrations, municipalities, and villages. Due to the COVID-19 pandemic, the research was limited to Çanakkale province, where the researcher lives. The present study involves all the employees of the Social Support Services Department, which is related to the subject examined here. Interviews were performed with 10 participants (3 men and 7 women) because of flexible working hour arrangements. The mean age of participants was 42.2 years. Moreover, in the results section male participant 1 was referred to as E1, male participant 2 as E2, male participant 3 as E3, female participant 1 as K1, female participant 2 as K2, female participant 3 as K3, female participant 4 as K4, female participant 5 as K5, female participant 6 as K6, and female participant 7 as K7.

### **2.4. Pattern**

The present study was designed as phenomenology research, one of the qualitative research patterns. Phenomenology is a method defining the experiences of individuals in order to understand the importance of phenomena. In phenomenology, the main objective is to reveal the reality underlying the phenomena (Baş and Akturan, 2017: 85-91). This method is based on two approaches, which are descriptive and interpretative approaches. The present study was carried out using the descriptive phenomenology approach, in which the researcher focuses on the experiences of participants by leaving his/her own knowledge and judgments aside (Güler et al., 2015: 236-237). Moreover, the metaphor method was also used in this study. The metaphor method is a method revealing the similarities of phenomena by letting an individual explain it over different phenomenon/phenomena (Tıkman et al., 2017: 106).

### **2.5. Data Collection Method and Analysis Technique**

The data were collected using the interview method. The interviews were performed with 10 individuals working in the Social Support Services Department of Çanakkale Municipality by making use of a structured interview form consisting of a question. The participants were asked the question “Migration is like ..... because .....”. The objective in asking this question is to allow them to characterize the migration over a living/non-living or tangible/intangible entity by using the preposition “like”. Moreover, the conjunction “because” was used in order to have them explain why they used the entity in characterization. First, the answers given by the participants were transcribed to a Microsoft Office Word file. Then, by using the MAXQDA Analytics Pro 2 (20.2.2)

analysis software, the citations to the determined metaphors and the relationships established between them were presented.

### 3. RESULTS

The metaphors used by the employees working in the Social Support Services Department of Çanakkale Municipality are presented in Table 3.1.

**Table 3.1.** List of metaphors used

No.	Metaphor used	f
1	River	1
2	Loss	1
3	Law	1
4	Exile	1
5	Emptiness	1
6	Irregularity	1
7	Unknownness	2
8	Seeking for Hope	1

As a result of the study, 8 metaphors related to the concept of migration were achieved. One participant was not involved since he couldn't create a metaphor. Two of the participants used the metaphor "unknownness", while the other metaphors were river, loss, law, exile, emptiness, irregularity, and seek for hope. The explanations of participants for the metaphors by considering them as themes are presented in Figure 3.1.

**Figure 3.1.** Code Matrix Scanner presenting the frequency of statements related to the sub-codes

Kod Sistemi	Erkekler	Kadınlar	TOPLAM
🔍 Bilinmezlik		6	6
🔍 Umut Arayışı	4		4
🔍 Düzensizlik	3		3
🔍 Kanun	2		2
🔍 Nehir	2		2
🔍 Boşluk	1		1
🔍 Sürgün	1		1
🔍 Kayıp	1		1
📊 TOPLAM	7	13	20

Examining the opinions of participants given Figure 3.1, it can be seen that the coding frequency was 30% for unknownness, 20% for seeking for hope, 15% for irregularity, 10% for law, 10% for river, and 5% for emptiness, exile, and loss.

## Unknownness

“Migration is to leave their homes, where they have been born and raised, and to settle in a different location sometimes willingly and sometimes unwillingly. In other words, it is a journey to the unknown” (K2).

“Migration is like a journey to the unknown” (K5, Metaphor).

“It refers to people settling in different cities in different geographies in terms of political, economic, social, and cultural aspects. Its end is the unknown” (K3).

“It refers to individuals slid into the unknown by leaving their home, in which they exist and live, generally due to economic problems and trying to attain a new life” (K4).

“The concept we call migration is not like moving from one place to another one. It is like a change of location due to forcing factors in places, where they live, such as war, unemployment, drought, hunger, etc. The concept called migration refers to leaving the place, in which we have been born and raised into our thoughts, and trying to establish a new living environment for us in the new place. It is difficult, like a journey to the unknown” (K6).

“Migration is the departure to the unknown as a result of a despair” (K7).

Although there was 1 metaphor about the unknown, it can be seen that 6 participants used this term and felt concern and fear. However, it is not a concern arising from the distrust towards the migrations but the participants’ concern about the concept of migration. Most of the participants put emphasis on the concept of “country”, which they called the place where one has been born and raised, and stated that getting away from that place would bring concern and unknownness.

## Seek for Hope

*“People generally migrate to find a job, to feel full, and to maintain their lives. In other words, people migrate for hope” (E2).*

*“The labor migration to the places because of the job opportunities is generally performed for hope” (K6).*

*“Migration is like a seek for hope” (K7, Metaphor).*

*“People migrate to different places because they couldn’t achieve wealth due to reasons such as they couldn’t find what they looked for or because of forcing reasons such as war” (E1).*

The other point that the participants emphasized was the hope. Although they interpreted the migration movement as a journey to the unknown, they also stated that people migrate because they hope something would change.

## Irregularity

*“The complete stop of migration on the earth would cause the cease of interaction between the individuals and it might cause an increase in international polarization and racism. Societies would adopt bias by isolating them from other societies. In this case, just like a river that flows the good and beautiful continuously and benefitting all objects and living creatures, the migrations benefiting the geographies, which should be developed from various aspects, on the earth should occur. Otherwise, irregularity might concur the world” (E1).*

*“Migration reminds me of population explosion and irregularity” (K5, Metaphor).*

In the theme “irregularity”, the participants stated that they were concerned that chaos might arise in case of the disturbance of the order. Besides that, they related the reason for this irregularity to the intensity of migration. Moreover, they also stated that, in case of the absence of migration, there would be irregularity and societies would become inner-oriented and more nationalist.

## Law

*“Migration is like a law of nature” (K1, Metaphor).*

*“As the birds and other animals migrate in order to achieve better living conditions, people migrate too” (K2).*

Migration was interpreted as a concept within the life itself, and it was emphasized that the migration of people is a flow just like other living creatures.

## River

*“Migration is like a river” (E1, Metaphor).*

*“A river would convey all the useful and harmful things it has from somewhere to another place. With this example, it can be stated that migration is both useful and harmful. Just as a river increases productivity and benefits a place and an ecosystem with the useful minerals and bacteria in its water; it also brings drought (rather than fertility) by means of harmful minerals, bacteria, and microorganisms it conveys. Migration is something like that. For instance, a migrating society would help or harm the receiving societies through the belief styles, morals, and many other characteristics. It might damage all the grown and cultivated products in case of an overflow, and it damages the soil. Migration is like that; a migration wave would economically affect the receiving geography” (E1).*

Using the river metaphor created by a participant, the possible positive and negative results of migration were emphasized. Migration

is not only a journey of a person/society to a different location, but it also is the transfer of culture together with the individuals. From this aspect, the participant discusses and interprets the migration concept as a social phenomenon. Similarly, it was also stated that mass migration movements would remarkably harm the countries from the economic aspect, but reasonable migrations would also contribute to the economy of the receiving country.

## Emptiness, Exile, and Loss

*“Migration is like an emptiness”* (K4, Metaphor).

*“Migration is like an exile”* (K3, Metaphor).

*“Migration is like trying the place where you were born”* (E2, Metaphor).

It can be seen that the perceptions about the migration concept were mainly based on concerns and fear. The perspectives of participants on the concept of migration show that they had concerns about migrating and they considered the places, where they have been born and raised, as safer places. Figure 3.2 was prepared in order to understand if there was a relationship between the metaphors used by the participants and their opinions about migration.

**Figure 3.2.** Relationship between the themes

### Kod Birlikte Oluşma Modeli (Kod Birlikte Oluşumu)

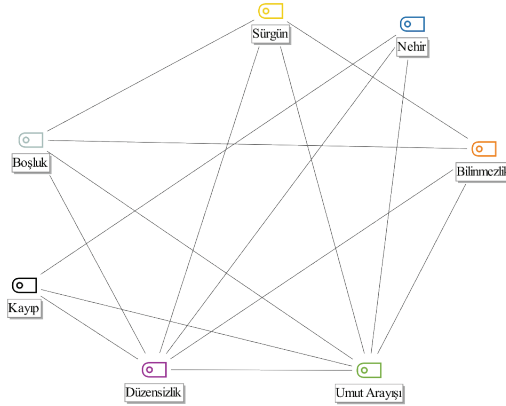

As seen in Figure 3.2, there are intense relationships between the metaphors used for the migration concept. They mainly emphasized the concept of migration as a concept involving negativity. It can be seen that irregularity and unknownness feel unsafe.

**Figure 3.3.** Two-Case Model representing the differences and similarities of female and male participants' perceptions of the migration concept

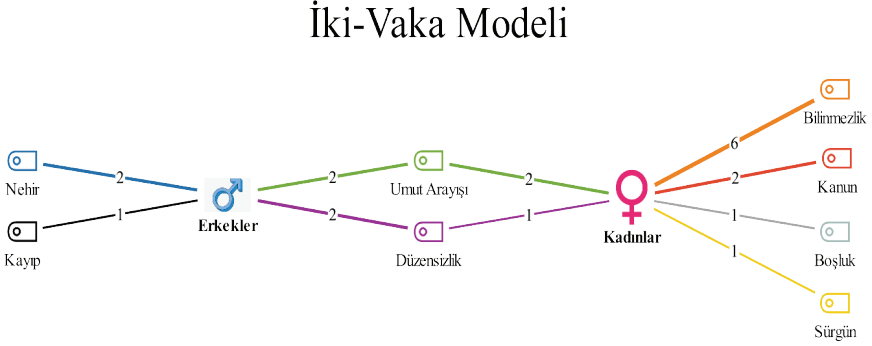

The differences and similarities between female and male participants regarding the concept of migration are shown in Figure 3.3. At this point, it can be seen that female participants generally concentrated their perception of migration on the unknownness. However, it was observed that the participants in both groups did not have very positive perceptions regarding migration. It is considered that the participants interpreting the migration as the seek for hope thought that people were actually having a journey to the unknown.

## Conclusion

The concept of migration, which has become complex and multidimensional, became a shared problem of all countries and it is a necessity to make effective policies to solve the problem. Besides the governments, also the local administrations have important roles in the phase of making policies. In particular, local administrations play important roles in taking the steps that are necessary to have the migrants and local people live in harmony with each other. In this parallel, how the local administrations' departments related to the migrants perceive the migration concept is important because the individuals' perceptions influence their approaches to a problem and their decisions. For this reason, this study aims to determine the prominent factors regarding the perceptions of individuals, who work in the Social Support Services Department of Çanakkale Municipality, about migration by making use of the metaphor method. It was aimed to find the answers to the following questions about the persons working in the aforementioned department: 1) What are the factors coming forefront in their perception of the migration, and 2) Is there a difference between women and men working in the Social Support Services Department of Çanakkale Municipality.

The prominent factor in the perceptions of individuals working in the Social Support Services Department of Çanakkale Municipality regarding

the migration concept was the unknownness. Most of the participants interpreted the migration as taking a journey with no known ending. Here, it can be seen that people have concerns and fears because leaving their homes, where they have been born and raised, would cause anxiety and they would face the unknown since they would leave their safe environments. Participants were seen to generally consider the migration as a forced migration. This is the main reason for their concerns because a forced migration is an escape from an unsafe environment and it causes uncertainty and emptiness in individuals.

It was concluded that there was no difference between female and male participants, who were working in the Social Support Services Department of Çanakkale Municipality, in terms of the perception of migration. It can be seen that the participants in both groups have generally no positive thoughts about migration. However, female participants ascribed an “uncertainty” meaning to the migration more than male participants. Only 1 participant emphasized the necessity of/need for migration. The Syrian migrant problem, which has been experienced in recent years, was interpreted as a negativity, but it was also stated that the complete absence of migration would cause inner-orientation among the societies and increase racism.



## REFERENCES

- Aydemir, S., Şahin, M. C. (2018), “Zorunlu-Kitlesele Göç Olgusuna Sosyolojik Bir Yaklaşım: Türkiye’deki Suriyeli Sığınmacılar Örneği”, *Dini Araştırmalar*, 21(53): 121 – 148.
- Baş, T., Akturan, U. (2017). *Sosyal Bilimlerde Bilgisayar Destekli Nitel Araştırma Yöntemleri*, Ankara, Seçkin Yayıncılık.
- BBC News (2021), <https://www.bbc.com/turkce/haberler-turkiye-58180854> (11.08.2021).
- Capra, F. (2012), *Batı Düşüncesinde Dönüm Noktası*, (Çev. Mustafa Armağan), İstanbul, İnsan Yayınları.
- Castles, S. (2002), “Migration and Community Formation Under Conditions of Globalization”, *International Migration Review*, 36 (4): 1143-1168.
- Castles, S., Mark J. M. (2008), *Göçler Çağı: Modern Dünyada Uluslararası Göç Hareketleri* İstanbul, İstanbul Bilgi Üniversitesi Yayınları.
- Çelebi E. C. (2020), “Göçün Öteki Yüzü, Türkiye Çağdaş Sanatında Göç Olgusu”, *Ulakbilge*, 47: 400–407.
- Çevik, H. H. (2012), *Kamu Yönetimi Kavramlar- Sorunlar-Tartışmalar*, Ankara, Seçkin Yayıncılık.
- Daoudov, M. (2015), “Göç Politikasında Söylem- Eylem Dönüşümü ve Belediyeler”, *Türkiye Sağlıklı Kentler Birliği Kent ve Göç Konferansı Bildiriler Kitabı*, 27- 33.
- De Haas, H., Czaika, M., Flahaux, M.L., Mahendra, E., Natter, K., Vezzoli, S., Varela, M. V. (2019). “International Migration: Trends, Determinants, and Policy Effects”, *Population and Development Review*, 45 (4): 885-922.
- Demirhan, Y., Aslan, S. (2015), “Türkiye’nin Sınır Ötesi Göç Politikaları ve Yönetimi” *Birey ve Toplum*, 5(9): 23-62.
- Deniz, T. (2014), “Uluslararası Göç Sorunu Perspektifinde Türkiye”, 18(1).  
Göç Terimleri Sözlüğü (2009), Uluslararası Göç Örgütü.
- Güler, A., Halıcioğlu, M. B., Taşgın, S. (2015). *Sosyal Bilimlerde Nitel Araştırma*, Ankara, Seçkin Yayıncılık.
- Karataş, K., Ayyıldız, A. (2021), “Bugünün Türkiye’sinde Göç Gerçeği: Küresel Hareketliliğin Neresindeyiz?” *İstanbul Aydın Üniversitesi Sosyal Bilimler Dergisi*, 13(2): 473-500.
- Keskin, İ. F., Yanarışık, O. (2021), *Suriye Göç Krizi Hakkında Güvenlik Endişeleri: Türkiye ve AB Ülkeleri Karşılaştırması*, *Güvenlik Çalışmaları Dergisi*, 23(1): 54-70.
- Okolski, M. (1999), “Migration Pressures in Europe, European Populations: Unity in Diversity”, *Kaa, Dir Van de, Gesena, Guisepe (der.)*, *European*

Association for Populations Studies, Netherlands, Kluwer Academic Publishers.

- Öner, A. Ş. (2018), “Göç Çalışmalarında Temel Kavramlar, Öner, Aslı Şirin, Öner, Gülfer İhlamur (der.), Küreselleşme Çağında Göç- Kavramlar, Tartışmalar, İstanbul, İletişim Yayıncılık.
- Rajca, L. (2020), “The Role of Cities in the Integration of Immigrants in Europe”, *Studia Europejskie*, 24(3): 165–181.
- Ray, B. (2003), “The Role of Cities in Immigrant Integration” <http://www.migrationpolicy.org/article/rolecities-immigrant-integration> (01.10.2003).
- Sargut, A. S. (2001), *Kültürlerarası Farklılaşma ve Yönetim*, Ankara, İmge Kitabevi.
- TDK. <https://sozluk.gov.tr/> (18.05.2021).
- Tıkman, F., Yıldırım, E., Şentürk, M. (2017), “Göç Metaforuna Yolculuk: Bir Fenomenolojik Çalışma”, *Sosyal Bilimler Dergisi*, 7(14): 104-126.
- Zanker, J. H. (2008), “Why Do People Migrate? A Review of the Theoretical Literature”, Maastricht: Maastricht Graduate School of Governance.

“

## Chapter 3

**TECHNOLOGICAL PROGRESS AND  
ECONOMIC GROWTH RELATIONSHIP:  
THE CASE OF TURKEY WITH  
ARTIFICIAL NEURAL NETWORKS  
METHOD<sup>1</sup>**

*Nazlı SEYHAN<sup>2</sup>*

*Burak SEYHAN<sup>3</sup>*

”

---

1 This book chapter has been developed from the abstract presented at the International Symposium of Economics, Finance and Econometrics 2022 in Çanakkale/ Turkey.

2 PhD, Research Assistant, Gumushane University, Dept. of Business, nazliarik@gumushane.edu.tr

ORCID: 0000-0003-0759-9119

3 Research Assistant, Gumushane University, Dept. of Economics, burakseyhan@gumushane.edu.tr

ORCID: 0000-0003-1026-1805

## **Introduction**

Today, countries focus on economic policies that will provide scientific and technological development in order to increase their welfare levels by making growth sustainable and to have a say in global competition. As a matter of fact, it is seen that the contribution of technological development to the development levels of countries such as the USA, Germany and Japan is quite high. On the other hand, it has been observed that the economic development of the countries that cannot keep up with the technological developments remains low compared to other countries.

Innovation activities are generally included in R&D activities and are important for the economic growth of developed countries (Stokey, 1995: 469). R&D, which is a technology indicator, is shown as the main reason for the differences in the economic development of countries and income divergence. The use of advanced technologies in enterprises and countries will enable the acquisition of useful new products and will increase economic growth and living standards with R&D investments. In this case, in order to guarantee economic growth, the government's incentives for R&D investments and the need to increase the amount of resources allocated to R&D in enterprises arise (Bilbao-Osorio and Rodriguez-Peso, 2004: 434-435).

## **Technological Progress And Economic Growth**

Technology can be expressed as a factor that enables to make innovations in production equipment, production methods and products, to increase production with these innovations, to provide competitive advantage and to increase earnings (Turkish Technology Development Foundation-TTVG, 2010: 7). Recently, with the development of science, technological change has become a triggering force in increasing economic performance. The production, dissemination and use of knowledge has become the most important resource that leads to gaining competitive advantage, increasing the level of welfare and increasing the quality of life (OECD, 2000: 1).

Following Griliches (1958)'s pioneering study of the American agricultural sector, studies focusing on the impact of R&D activities on output, productivity and economic growth have been conducted. For example, significant research was carried out by the American Bureau of Labor Statistics (BLS), 1989, until the mid-1980s. In addition, Goel and Ram (1994) similarly conducted research on the subject. The findings of these studies show that the increase in R&D activities positively affects economic growth. For this reason, interest in R&D activities has increased and countries have started to support R&D activities with various policies (Goel et al., 2008: 238).

It is known that countries have various socio-economic characteristics that will affect innovation and growth in R&D investments. As a matter of fact, there are societies that can direct R&D expenditures to innovation and economic growth (innovation prone societies) and societies that cannot direct R&D expenditures to innovation and growth (innovation averse). Educational level, unemployment and many demographic features and investment volume are the factors that affect societies. It also requires good education, scientific and technological knowledge and long-term experience. The economic conditions in the countries will also reflect the amount of resources and sectoral development level of R&D investments (Bilbao-Osorio and Rodriguez-Peso, 2004: 438).

In the 1980s, Romer (1986) and Lucas (1988) put forward the endogenous growth model, in which technology is seen as an important internal factor affecting economic growth. In the endogenous growth model, it is stated that increasing returns on investments will be possible due to technological development. In this case, it is accepted that better results will be obtained from investments in developed countries and thus divergence will be observed. (Bilbao-Osorio and Rodriguez-Peso, 2004: 435).

It is stated that the technological innovations realized by the units aiming at profit maximization in the endogenous growth models through R&D investments are the source of economic growth. Based on these results of the endogenous growth literature, the idea that long-term economic growth can be accelerated with the encouragement of R&D activities and additional policies to support R&D has become widespread (Jones, 1995: 759).

### **Literature**

There are many studies in the empirical literature analyzing the relationship between technological progress and economic growth. Solow (1956) incorporated technological progress into his growth model and Barro (1991) developed this model empirically Barro and Sala-i-Martin (1992) and Mankiw et al. (1992) emphasized the importance of technological progress as the main contributor to long-term economic growth. Technological progress was considered exogenous according to the Solow growth model, which enabled it to be included as a new growth theory in the literature (Donou-Adonsou et al., 2016: 67). Lucas (1988) internalized technological change determined by human capital. On the other hand, as other researchers interested in technological progress, Romer (1990) discussed the economics of creative ideas, Aschauer (1989) discussed infrastructures, Grossman and Helpman (1991) discussed innovations and Aghion and Howitt (1992) discussed improvement in the

quality of existing products and showed their links to growth. However, the inclusion of telecommunication infrastructure in the growth model has been one of the important developments. Oliner and Sichel (1994, 2000) and Jorgenson and Stiroh (1995, 1999) are researchers who use information technology with a growth model.

The questions that Ayres (1996) seeks to answer are: i) Can technological progress negatively affect economic growth? ii) How much human well-being can be attributed to science and technological progress? According to the result obtained in the study, increasing welfare is primarily due to scientific development.

Jalava and Pohjola (2005) investigated the effects of Information and Communication Technologies (ICT) on the level of output and the increase in labor productivity by considering the period 1995-2002 for Finland. According to the findings, the contribution of ICT to GDP as a component of both output and total input is 4.09%. 1.08% of the increase in labor productivity with an average growth rate of 2.51% belongs to ICT. The contribution of capital deepening in ICT is 0.6%. Considering the multi-factor productivity in ICT production, its contribution to GDP per working hour is 1.08%.

Gani (2009) dealt with high technology exports and economic growth as variables in his analysis. In this context, he divided the countries into three in terms of technological development: technology leader countries, potential leader countries and dynamic adopter countries. The regression results show that high technology exports affect economic growth positively in technology leaders. However, there was no significant relationship in other country groups.

Rudolf and Zurlinden (2009) investigated the sources of economic growth for Switzerland in 1991-2005. The results reveal that labor and capital input contributed 0.57% and 0.45%, respectively, to the 1.28% average increase in GDP over the period under consideration. The 0.25% portion represents the growth in multi-factor productivity. The growth rate in multi-factor productivity was found to be lower than the values calculated in previous studies because the estimated workforce changes were calculated taking into account the quality of the workforce. Changes in workforce quality explain 0.39% of the 0.45% point contribution of workforce quality to GDP growth.

Pipitone (2009) investigated the role of technological progress in the economic growth of Mediterranean countries using TFP data. According to the results of the analysis, although physical capital is an important factor in economic growth and has a positive value, the contribution of human capital to growth remains low. TFP has a positive effect, especially

in some transition countries that have achieved high growth rates, but its role in this process differs from country to country.

In Kim (2009), the relationship between economic growth and exports is explained by focusing on the level of technological exports. The technological export levels of the countries were measured using trade data and the importance of the technological export level in determining economic growth was analyzed. The results show that the technological level of exports is more important than the amount or openness of exports for long-term economic performance.

Altın and Kaya (2009) questioned the causality relationship between R&D and economic growth for Turkey using cointegration analysis and vector error correction model. In the study, no causality relationship was found in the short term, but a one-way effect from R&D expenditures to economic growth was detected in the long term. Similarly, Yaylali et al. (2010) analyzed Turkey for the period 1990-2009 with the Granger causality test. The results obtained in the study indicate a relationship from R&D expenditures to economic growth.

Adak (2015) focused on the impact of innovation and technological progress on the Turkish Economy. He analyzed the interrelationship between technological progress and economic growth using quantitative methods. The findings obtained as a result of the study show that innovation and technological progress have a significant impact on economic growth.

Junoh (2004) conducted a comparative analysis between ANN and econometric methods for predicting GDP growth in Malaysia. He used knowledge-based economic indicators based on time series data collected between 1995-2000. According to his findings, with comparison to traditional econometric methods, it was determined that ANN increased its potential to predict GDP growth based on information-based economic indicators.

Duzgun (2008) made a GDP estimation for Turkey by using quarterly data, ANN and ARIMA models for the period 1987-2007. As a result of the research, it was seen that the ARIMA results are better than the ANN.

Using the ANN method, Liliana and Napitupulu (2010) analyzed some variables such as GDP growth, political stability and security conditions for Indonesia in the previous two periods. From this study, it was found that ANN predicts GDP better than government-published values.

Maliki et al. (2014) discussed the nexus between stock market index value and economic growth in their research and concluded that all of the variables in the model are highly correlated. According to them, ANN gives better results than regression analysis in efficiency comparison.

Pasarica and Popescu (2015) investigated the factors affecting GDP in exit economies such as Romania. They found that factors such as, agriculture, construction, retail have positive and negative effects. Pasarica and Popescu suggested that this research provides a pathway between neural network backpropagation and regression models. According to their findings, neural networks have an a powerful structure for modeling and forecasting GDP.

Söyler and Kızılkaya (2015) used Multi-Layer Sensor (ÇKA), Radial Based Function Networks (RTFA) and reversible Elman Network as tools to make the definition of GDP. It was seen that the RFTA model provided the highest value in the models, so economic growth forecasts for the 2013:2014 periods were made with this model. It was concluded that ANN is a successful for predicting growth.

Vrbka (2016) mentioned that artificial intelligence is a known application for forecasting GDP. In his research, he applied ANN to predict the GDP growth of countries in the Euro Zone until 2025.

Jahn (2018) conducted a study covering the period 1996-2016 to estimate the GDP growth rate of fifteen industrialized economies. As a result of the analysis, it was determined that the ANN gave more accurate predictions than a traditional model in estimating the GDP growth rate. It was emphasized that ANN models especially captured time trends very well.

When we look at the literature, it has been determined that many studies in which the ANN model gives good results for GDP estimation in general. It is also seen from these studies that the predictive power of ANN models is higher than other models.

### **Methodology**

ANN, which is characterized as information processing processes, can also be described as a detailed black box model that produces outputs against the given inputs. Although ANN is defined as a similarity to the nervous system formed by a group of nerve cells that provide information flow with the help of axons, it is generally defined as networks that occur by intensely parallel connection of simple elements that are repeatable (adaptive) (Kohonen, 1988). ANN studies, which started with mathematical models based on human brain neurons in neuroscience, are used in many different branches of science today and are studied as research subjects in applications such as pattern recognition, classification, control and prediction.

Artificial neural networks give similar reactions to similar events by performing machine learning. Thanks to the examples shown to him by



the researcher, he can produce information about previously unforeseen data (Öztemel, 2006: 32). These advantages enable researchers to obtain powerful analysis results in forecasting and forecasting problems.

A neural network cell consists of five elements called inputs, weights, sum function, activation function and output. In the nerve cell, there are inputs that represent the information coming from outside, and weights that show the effect and importance of the inputs in the cell. While it calculates the net input in the cell with the sum (joining) function, it converts the results in the sum function into output with the activation (activity, threshold, transfer) function. Cell output is the output value determined by the activation function (Öztemel, 2003). A multi-input multi-output neural network with a single hidden layer is shown as in Figure 1 and expressed mathematically as in (1.1).

Figure 1. Artificial Neural Network Architecture

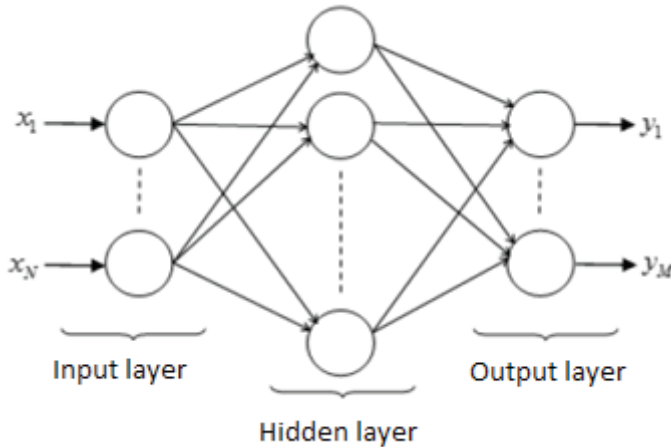

$$y[k] = w_0^T[k] f(w_i^T[k]x[k] + b[k])$$

Where  $x[k]$  and  $y[k]$  represent the input and output variables,  $w_i^T[k]$ ,  $w_0^T[k]$ ,  $b[k]$  represent the weight matrix of the input layer, the weight matrix of the output layer, and the bias vector, respectively. These parameters need to be optimized according to the objective function defined by an optimization technique. Generally, it was seen that good results were obtained with the Levenberg-Marquardt (LM) algorithm on ANN (Yu and Wilamowski, 2011). For this reason, in this study, feedforward-backpropagation ANN model was used for minimizing the unknown parameters mean square error objective function with the LM algorithm, due to its widespread use, flexibility and adaptability to modeling a wide range of problems.

Lin et al. (1996), the NARX network is used effectively especially when it comes to non-stationary time series. The NARX network is a feedback and forward computational dynamic network. In future estimation studies, historical values of time series are used to predict future values in dynamic networks such as NARX (Boussaada et al., 2018: 3-4). The mathematical representation of the NARX network using historical values for future predictions is as follows:

$$y(t)=f(y(t-1),y(t-2),\dots,y(t-n_y),x(t-1),x(t-2),\dots,(t-n_x))$$

In the function of the NARX network, the network inputs  $x(t-1),x(t-2),\dots,(t-n_x)$  Mathworks are shown, while the network outputs are  $y(t-1), y(t-2)$  and  $y(t-n_y)$  is shown as. Where  $n_x$  is the number of past inputs to be applied for the feedback,  $n_y$  is the number of past outputs (Mathworks, 2018). While the sigmoid activation function is used in the hidden layer in NARX networks, the linear activation function is used in the output layer (Yılmaz, 2015: 30).

The developed computer programs provide great advantages in terms of reaching the result easily and quickly in both traditional methods and ANN models. In this study, both causality tests and artificial neural network models were used to determine the relationship between variables. Nonlinear External Input Autoregressive Network (NARX) model and Feed-forward model of artificial neural networks were used.

### Empirical Analysis And Findings

The variables used in the study and the information about the variables are shown in Table 1. The data in the study is taken annually and covers the period of 1996-2019 for Turkey. The data were obtained from the world bank database. There are one dependent variable (Economic growth) and four independent variables (patent expenditures, R&D expenditures, capital and trade openness) in the study. The variables used in the study were selected after reviewing the relevant literature.,

*Table 1. Variables Used in the Study and Their Sources*

Variables	Period/Source
Patent expenditures (TEK)	1996-2019 WDI
R&D expenditures (ARGEHARC)	1996-2019 WDI
Capital (SER)	1996-2019 WDI
Trade openness (TIC)	1996-2019 WDI
Economic growth (GDP)	1996-2019 WDI

In this study, Granger Causality Tests and Nonlinear External Input Autoregressive Network (NARX/Nonlinear Autoregressive Exogenous) and feedforward network models of artificial neural networks were used

for Turkey's technological economic growth relationship and prediction. EViews and MATLAB program were used in the study.

### **Causality Test Findings**

In the study, 5 cointegrated vectors were determined according to the results of the Engle-Granger Causality test. This finding led us to the conclusion that there is a significant relationship between the variables within the framework of the long-term model and that Granger Causality Test can be passed.

As a result of Granger Causality Test;

TEK is Granger Cause of GDP

GDP is Granger Cause of ARGE

GDP is Granger Cause of TİC

ARGE is Granger Cause of TEK

SER is Granger Cause of TEK

TEK is Granger Cause of TİC

ARGE is Granger Cause of SER

ARGE is Granger Cause of TİC

### **Non-Linear Autoregressive Network with External Input (NARX/ Nonlinear Autoregressive Exogeneous) Findings**

70% of the data set is reserved for training, 15% for validity, and the remaining 15% for testing. The structure of the NARX network, which consists of 4 independent variables and 1 dependent variable, where the number of delays is 2 and the number of hidden layers is 10, is shown in Figure 2. The NARX network was first trained with the relevant values.

**Figure 2.** *NARX ANN Model Profile*

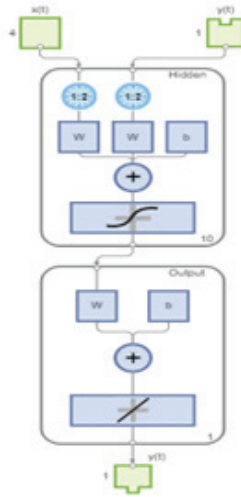

In this study, experiments were carried out using 2, 5, 7 and 10 hidden layers in order to achieve the best result. The best result was obtained by choosing 10 hidden layer. The model profile is given in Figure 2.

*Table 2. MSE and R Values Realized in Network Training*

	Mean Squared Error (MSE)	R Value
Train	0.0044	0.9788
Validation	0.013	0.9916
Test	0.0053	0.9987

Table 2 shows the MSE and correlation (R) values for the training of the network. Accordingly, the small MSE values and the high R values indicate that the training of the network is successful.

*Figure 3. Error Performances for Training, Validation, and Test Sets*

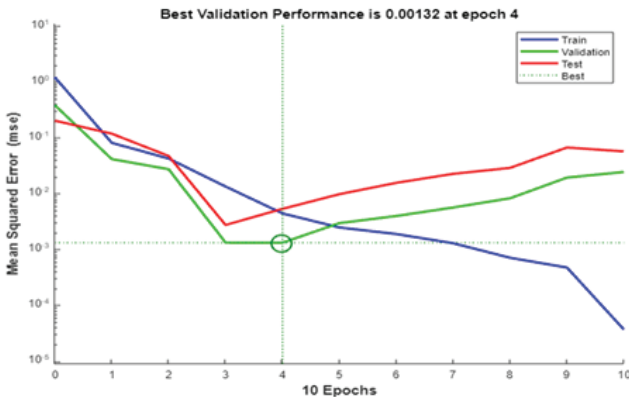

In Figure 3, it is seen that the network completed its training in the 10th iteration and the best validation performance was achieved in the 4th iteration.

Figure 3. Network Learning Curves

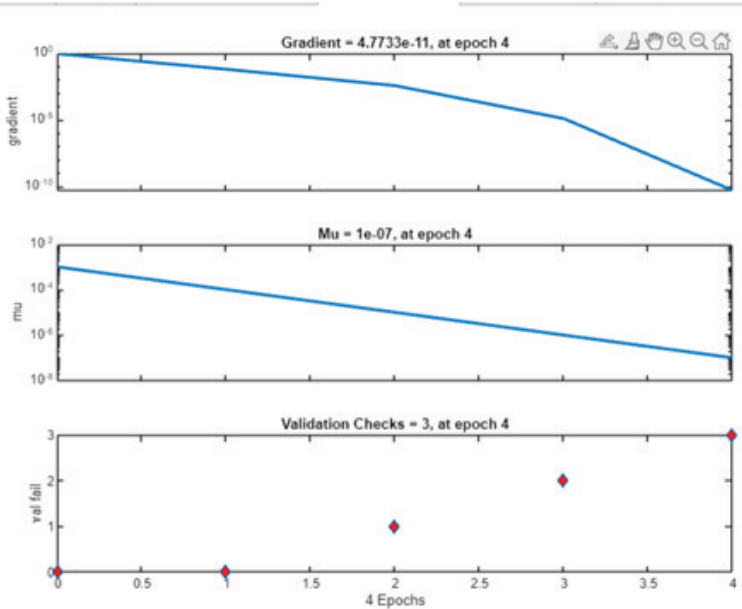

Gradient is a back propagation value for each iteration on a logarithmic scale. Accordingly, as seen in Figure 3, the value of 0.0040506 indicates that the target function has reached its local minimum.

Figure 4. Error Histogram of the Network

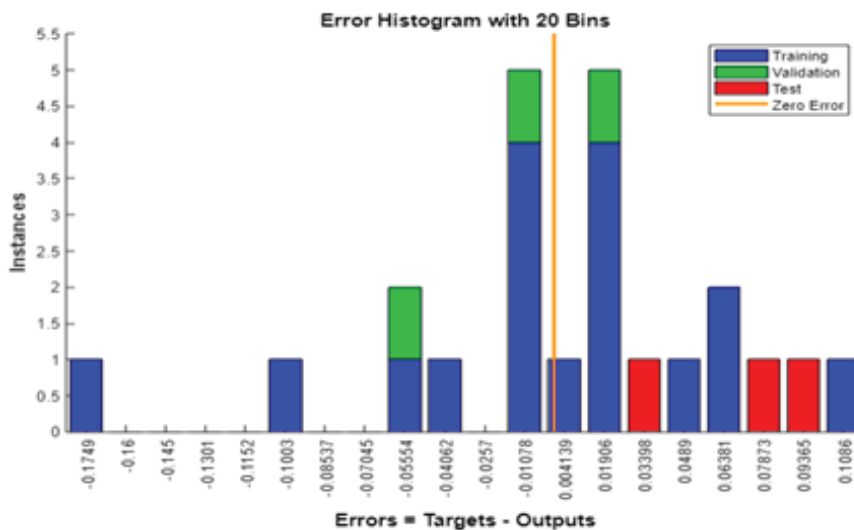

According to the error histogram in Figure 4, it can be said that the majority of the errors fall between -0.1003 and 0.1086.

Figure 5. Error Autocorrelation Plot of the Network

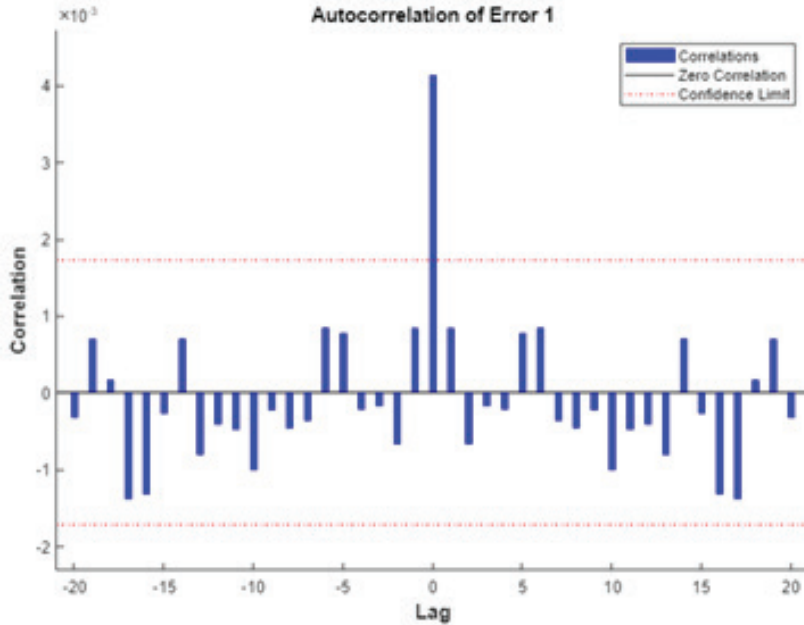

When the error autocorrelation graph is examined, there is one value exceeding the confidence interval at 0. This indicates that the estimation errors are uncorrelated (white noise). It is understood from the autocorrelation graph that the model is suitable.

In Figure 5, the R values of the data allocated for training, validation and testing in the trained network are shown before the future prediction is made. The graphs show that the R values are 79% and above. The learning process of the network has been accomplished with great success and the model has gained a fit appearance.

Figure 6. Artificial Neural Networks Performance Chart

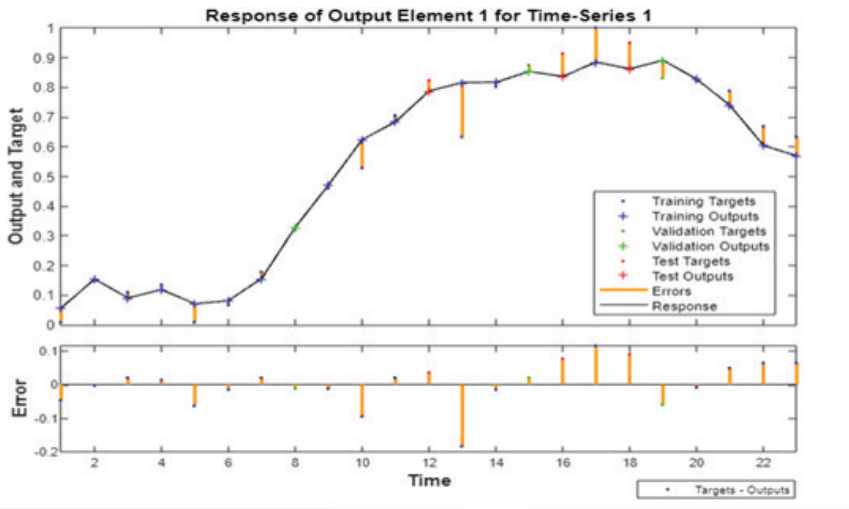

The suitability of the output and target values determined by the NARX ANN model for economic growth is shown in the graph above (Figure 6) ANN target and output values and error values. Artificial neural networks performance graph is included. According to this graph, it is noteworthy that the errors are generally low. In the model obtained, it is observed that the network prediction levels are successful in general, but the error value is a little high in 2008-2009 (one delay). Of course, like every economic variable, it is known that there are many internal and external factors that the economic growth variable depends on, and it is undeniable that these factors also differ periodically.

**Feed-forward Network Findings**

Another network model that we have considered in the scope of the study is the Feed-Forward model.

Figure 7. Feed-Forward ANN Model Profile

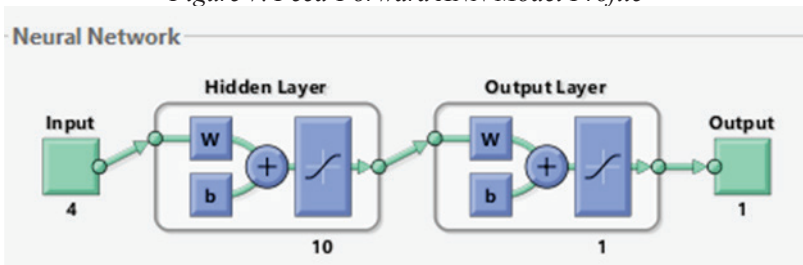
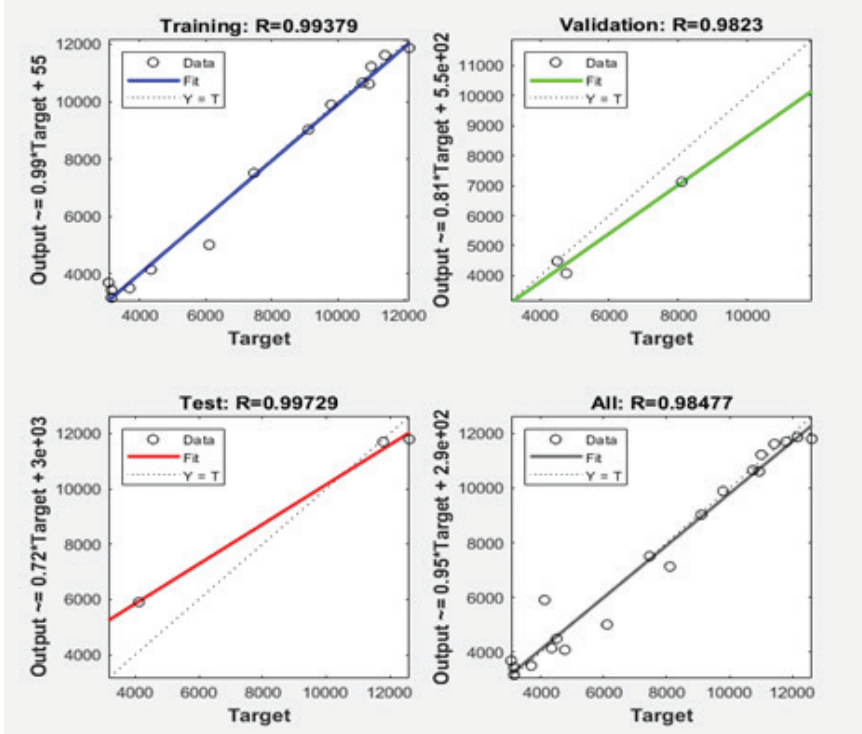

Figure 8. R Values of Training, Validity, Testing and All Results of ANN Model



The R values, which can take values between 0 and 1, reflecting the explanatory power of the model for training, validation, testing and all in the training of the network before making future predictions are seen in the figure. It is seen that the R values take values very close to 1 and this shows that the learning process of the model is successful.

Table 3. Comparison of Realized R Values in Training of NARX and Feed-forward Networks

	Train	Validation	Test	Best
NARX (R)	0.9788	0.9916	0.9987	-
Feedforward (R)	0.99379	0.9823	0.99729	0.98477



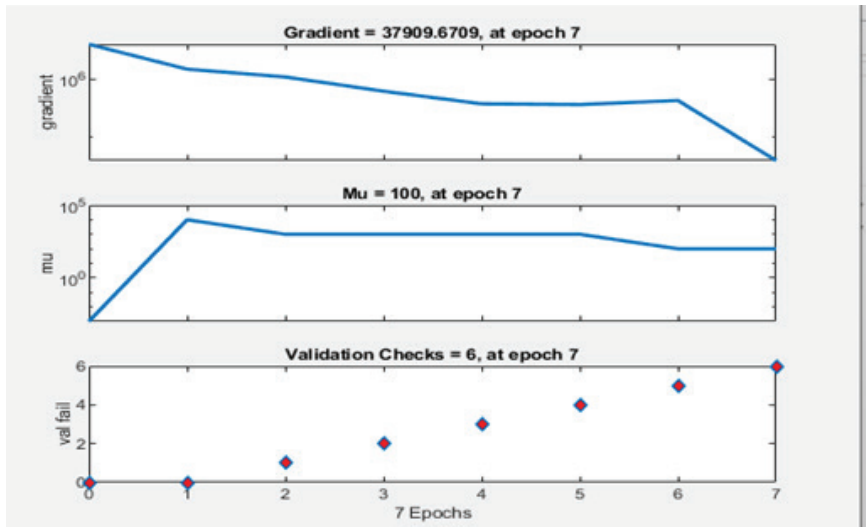
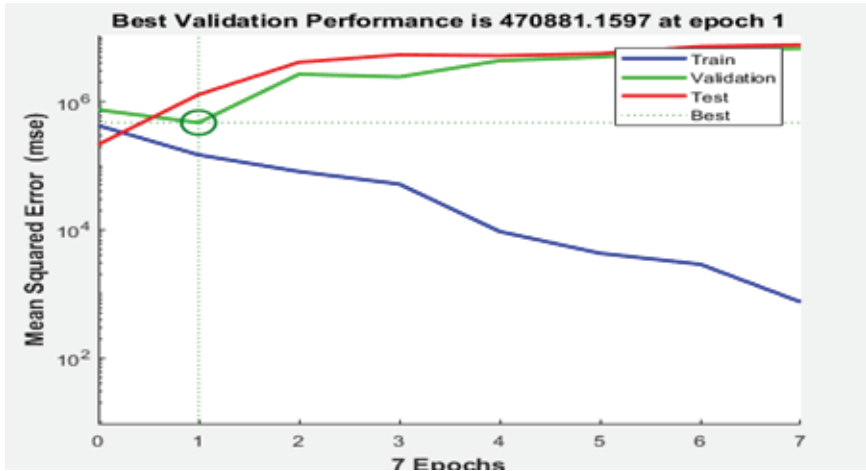
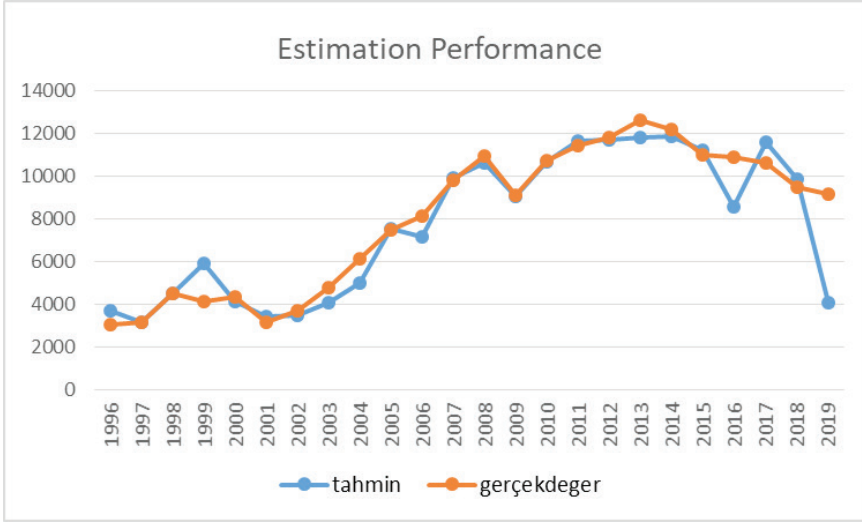

Figure 9. Economic Growth Actual and Forecast Values Graph



In the chart above, tahmin represents the estimation and gerçekdeğer represents the actual value.

The chart includes the actual and estimated values for Turkey's 1996-2019 period. Looking at the graph, it is seen that the estimated values and the actual values are very close to each other in 1996, 1997, 2000, 2001, 2002, 2003, 2005, 2007, 2008, 2009, 2010, 2011, 2012, 2014, 2015, 2017, 2018.

This shows that artificial neural networks give strong results in estimating economic growth with the help of independent variables (patent numbers, R&D expenditures, capital and trade openness) determined within the scope of the study.

### Conclusion and Proposals

As a result, artificial neural networks established by determining the appropriate network structure in the estimation of time series can be used as an alternative method to other statistical methods. Since the economic growth variable is closely related to many variables in macroeconomics, it is very important to be able to predict the economic growth rate. In this study, firstly, the relationship between the number of patents, R&D expenditures, capital and trade openness variables and economic growth determined after the relevant literature review was examined by causality tests.

According to the results of the Engle-Granger Causality test, 5 co-integrated vectors were determined, and the Granger Causality Test was applied between the variables within the framework of a meaningful

model showing the long-term relationship. As a result of the causality test; It has been found that technological progress is the Granger reason for economic growth, economic growth for R&D expenditures, economic growth for trade, R&D expenditures for technological progress, capital for technological progress, technological progress for trade, R&D expenditures for capital, and R&D expenditures for trade.

In addition, the relationship was modeled with the help of artificial neural networks and predictions were made with the help of the models obtained. In the study, the Nonlinear External Input Autoregressive Network (NARX) model and the Feed-forward model were used and the outputs of the models were compared. When the R values obtained from the training of NARX and Feed-forward networks are examined, it is seen that the training R values of both models (0.9788 and 0.99379) are high. According to the findings, it has been concluded that artificial neural networks are a successful method that can be used in predicting economic growth with the determined independent variables.

The positive contribution of R&D expenditures to economic growth by raising the technological development levels of companies and countries is now a generally accepted determination. Therefore, it is of great importance for the governments to increase such investments by the government, as well as to encourage the private sector in this area, in terms of R&D expenditures, which are among the most basic goals of today's governments, which lead to sustainable economic growth and increase in welfare levels.

## BIBLIOGRAPHY

- Adak, M. (2015). Technological progress, innovation and economic growth; the case of Turkey. *Procedia-Social and Behavioral Sciences*, 195, 776-782.
- Aghion, P., & Howitt, P. (1992). A model of growth through creative destruction. *Econometrica*, 60(2), 323–351.
- Altın, O., & Kaya, A.A. (2009), “Türkiye’de ARGE Harcamaları ve Ekonomik Büyüme Arasındaki Nedensel İlişkinin Analizi”, *Ege Akademik Bakış* 9: 251-259.
- Aschauer, D. A. (1989). Is public expenditure productive? *Journal of Monetary Economics*, 23(2), 177–200.
- Ayres, R. (1996). Technology, progress and economic growth. *European Management Journal*, 14(6), 562-575.
- Barro, R. J. (1991). Economic growth in a cross section of countries. *The quarterly journal of economics*, 106(2), 407-443.
- Barro, R. J., & Sala-i-Martin, X. (1992). Convergence. *Journal of Political Economy*, 120(21), 364–386.
- Bilbao-Osorio, B. & Rodriguez-Peso, A. (2004), “From R&D to Innovation and Economic Growth in the EU”, *Growth and Change*, 35 (4), 434-455.
- Boussaada, Z., Curea, O., Remaci, A., Camblong, H., & Mrabet Bellaaj, N. (2018). A nonlinear autoregressive exogenous (NARX) neural network model for the prediction of the daily direct solar radiation. *Energies*, 11(3), 620.
- Donou-Adonsou, F., Lim, S., & Mathey, S. A. (2016). Technological progress and economic growth in Sub-Saharan Africa: Evidence from telecommunications infrastructure. *International Advances in Economic Research*, 22(1), 65-75.
- Düzgün, Recep (2008), “A Comparison of Artificial Neural Networks and ARIMA Models Success in GDP Forecast”, *Marmara Üniversitesi Ğ. Ğ. B. F. Dergisi, Cilt.XXV, Sayı. 2, 2008, s. 165-176.*
- Gani, A. (2009), Technological Achievement, High Technology Exports and Growth, *Journal of Comparative International Management* , Vol. 12, N o.2, 31-47.
- Goel, R.K., Payne, J.E. & Ram, R. (2008), “R&D Expenditures and US Economic Growth: A Disaggregated Approach”, *Journal of Policy Modeling*, 30, 237-250.
- Griliches, Z. (1958), “Research Costs and Social Returns: Hybrid Corn and Related Innovations”, *Journal of Political Economy*, 66, 419-437.
- Grossman, G., & Helpman, E. (1991). *Innovation and growth in the global economy*. Cambridge, MA: MIT Press.

- Jahn, M. (2018), Artificial Neural Network Regression Models: Predicting GDP Growth, Hamburg Institute of International Economics, 185, 1-15.
- Jalava, J., & Pohjola, M., (2005), ICT as a Source of Output and Productivity Growth in Finland, HECER – Helsinki Center of Economic Research, Discussion Paper No.52, pp.1-11.
- Jones, C.I. (1995), “R&D-Based Models of Economic Growth” *Journal of Political Economy*, 103(4), 759-84.
- Jorgenson, D., & Stiroh, K. (1995). Computers and growth. *Economics of Innovation and New Technology*, 3(3-4), 295-316.
- Jorgenson, D., & Stiroh, K. (1999). Information technology and growth. *American Economic Review*, 89(2), 109-115
- Junoh, Mohd Z. H. M. (2004), ”Predicting GDP Growth in Malaysia Using Knowledge – Based Economy Indicators: A Comparison Between Neural Network and Econometric Approach”, *Sunway College Journal*, Vol. 1, 39-50.
- Kim, Jong (2009), The Technological Level of Exports and Economic Growth, *Journal of Economic Research* 14 (2009) pp. 285- 308.
- Kohonen, T. (1988). An introduction to neural computing. *Neural networks*, 1(1), 3-16.
- Liliana & Togar A. Napitupulu (2012), “Artificial Neural Network Application in Gross Domestic Product Forecasting an Indonesia Case”, *Journal of Theoretical and Applied Information Technology*, Vol. 45, No. 2, pp. 410-415.
- Lin, T., Horne, B. G., Tino, P., & Giles, C. L. (1996). Learning Long-Term Dependencies in NARX Recurrent Neural Networks. *IEEE Transactions on Neural Networks*, 7(6), 1329-1338.
- Lucas, R.E. (1988), “On Mechanism of Economic Development”, *Journal of Monetary Economics*, 22(1), 3-42.
- Maliki, O. S., Emmanuel, I. & Obinwanne, E. E. (2014), Neural Network Applications in the Forecasting of GDP of Nigeria as a Function of Key Stock Market Indicators, *Advances in Applied Science Research*, 5(3), 204-212.
- Mankiw, G., Romer, D., & Weil, D. (1992). A contribution to the empirics of economic growth. *Quarterly Journal of Economics*, 107(2), 407-437.
- Mathworks, 2018. Design Time Series NARX Feedback Neural Networks. [https://www.mathworks.com/help/deeplearning/ug/design-time-series-narx-feedback-neural-networks.html#responsive\\_offcanvas](https://www.mathworks.com/help/deeplearning/ug/design-time-series-narx-feedback-neural-networks.html#responsive_offcanvas) (Erişim Tarihi: 21.08.2020).
- OECD (2000), *Science, Technology and Innovation in the New Economy*, Policy Brief.

- OECD Science, Technology, and R&D Statistics, [http://www.oecd-ilibrary.org/science-and-technology/data/oecd-science-technology-and-r-d-statistics\\_strddata-en](http://www.oecd-ilibrary.org/science-and-technology/data/oecd-science-technology-and-r-d-statistics_strddata-en)
- Oliner, S. D., & Sichel, D. E. (1994). Computers and output growth revisited: how big is the puzzle? *Brookings Papers on Economic Activity*, 1994(2), 273–334.
- Oliner, S. D., & Sichel, D. E. (2000). The resurgence of growth in the late 1990s: is information technology the story? *Journal of Economic Perspectives*, 14(4), 3–22.
- Öztemel, E. (2003). *Yapay Sinir Ağları*, Papatya Yayıncılık, İstanbul.
- Pasarica, A. E., & Popescu, M. (2015), Prediction of the GDP of Romania Using Neural Networks, *İnterdisciplinary Approaches Between Traditional and Modern Methods Nord 1 International Conference*, Romania.
- Pipitone, V. (2009), The Role of Total Factor Productivity in the Mediterranean Countries, *International Journal of Mediterranean Studies*, Vol. 2(1), pp. 27-51.
- Romer, P. M. (1990). Endogenous technological change. *Journal of Political Economy*, 98(5), 71–102.
- Romer, P.M. (1986), “Increasing Returns and Long-Run Growth”, *Journal of Political Economy*, 94(5), 1002-1037.
- Rudolf, B., & Zurlinden, M. (2009), Productivity and Economic Growth in Switzerland 1991–2005, *Swiss National Bank Working Papers*, 2009-13.
- Solow, R.M. (1956), “A Contribution to the Theory of Economic Growth”, *Quarterly Journal of Economics*, 70, 65-79.
- Söyler, H. & Kızılkaya, O. (2015), Türkiye'nin GSYİH Tahmini İçin Yapay Sinir Ağları Model Performanslarının Karşılaştırılması, *C.Ü. İktisadi ve İdari Bilimler Dergisi*, 16(1), 45-58.
- Vrbka, J. (2016), Predicting Future GDP Development by Means of Artificial Intelligence, *Littera Scripta*, 9(3), 154-167.
- Yu, H., Wilamowski, B. M. (2011). Levenberg–marquardt training. *Industrial Electronics Handbook*, 5(12), 12-15.

“

## Chapter 4

### FINANCE GEOGRAPHY

*Sezen GÜNGÖR<sup>1</sup>*

*Nihan TOMRIS KÜÇÜN<sup>2</sup>*

*Kader EROL<sup>3</sup>*

*Hatice ER<sup>4</sup>*

”

---

1 Dr., Tekirdağ Namık Kemal Üniversitesi Çorlu Meslek Yüksekokulu, sezengungor@nku.edu.tr

2 Dr., Eskişehir Osmangazi Üniversitesi, nihan\_tomris@hotmail.com

3 Dr., Tekirdağ Namık Kemal Üniversitesi Çorlu Meslek Yüksekokulu, kkizilerol@nku.edu.tr

4 Dr. Öğr. Üyesi, Tekirdağ Namık Kemal Üniversitesi Çorlu Meslek Yüksekokulu, her@nku.edu.tr

Geography is important for investments. It becomes more important, especially in securities markets. One of the important factors behavioralists consider when trying to understand market behavior is geography, although mainstream economic theories do not support it. Familiarity bias, home bias, and “keep ours is ours” are mainly due to the geographical location of investments and investors. Many issues such as cities that are financial centers, financial crises that grow more with the effect of contagion, and the elimination or inability of the geographical boundaries of trade in the virtual environment are included in the subject of financial geography.

The aim of this article is to review the literature investigating the intersection between stock markets and geography, a large part of which comes from financial economy and economic geography, and to relate investors, investment instruments, and cities with each other by considering stock market investors in Turkey, and to reveal an investment map on a city basis. In other words, the main goal is to discuss how geography still matters for stock market actors and their interactions despite the ongoing globalization of securities markets, the connection between geography and the tendency to keep investments close to home due to home bias, and the significance of which Turkish city to invest in terms of nationality and type of investment.

Since the study aims to take a photograph of the Turkish stock market, it only includes data for May 2022. The data includes government securities, private sector debt securities, structured products, funds, and other securities other than stocks. The diversification of the asset classes is important in terms of revealing the asset class preference geographically. In addition, the nationality of the investors is accepted as another data set. Including this breakdown in the study is important in terms of examining domestic and foreign stock market participants in Turkey.

### **What is finance geography?**

The finance geography literature is largely concerned with the spatial relationships between markets around the world (Clark, 2002; Clark and Wójcik, 2005; Engelen and Grote, 2009; Lee et al., 2009; Martin, 2011; and Wójcik, 2013). From a spatial perspective, the cities where the exchanges are located play a crucial role as key elements in a global network where they are located on the map of international exchange trading centers. This network has been extensively studied in the literature, both conceptually and theoretically, from two different perspectives: external and internal networks. External networks refer to traditional economic geography (Yeung and Kelly, 2007; Garretsen and Martin, 2010). On the other hand, models based on “new” economic geography have emerged, which see the development of markets as the internal result of the behavior of economic



and financial agents, both individually and as part of a network (Martin, 1999; Krugman, 1998; Behrens and Thisse, 2007).

Existing literature in economic geography and especially financial geography covers topics such as; positional advantages in the financial services industry (Clark, 2002), the role and structure of stock markets in different geographical regions (Peck and Theodore, 2007; Clark and Wójcik, 2007), centralization and decentralization processes in financial systems (Klagge and Martin, 2005), global corporate governance in financial markets (Clark, Wójcik and Bauer, 2006 and Clark and Wójcik, 2007) or the increasing role of the virtual space in stock trading (Wójcik, 2007).

It is clear that globalization and the apparent virtualization of stock markets do not make the position less important. This argument is supported by evidence focused on the behavior of issuers and investors. They cross-list their overseas shares to enter companies' foreign capital pools or increase their visibility. However, companies are influenced by distance and cultural proximity when choosing overseas listing locations. US stock markets nearly monopolize cross-listing in the Americas, while firms in India, South Africa, or Australia mostly cross-list on the London Stock Exchange (Sarkissian and Schill 2004). It is also notable that trading in cross-listed firms tends to stubbornly cling to the stock market in the home country (Halling et al. 2007). Evidence that location remains important can also be found when analyzing listing decisions within countries. Loughran and Schultz (2006) show that US firms in rural areas wait longer to list their stocks than urban areas, are less likely to offer stocks when traded, use lower quality intermediaries in public offerings, and have more debt in their capital structure. . Wójcik (2008a) expands on these findings, showing that firms in financial centers are more likely to go public than their provincial counterparts. This phenomenon, called financial center bias, is valid in the absolute majority of European countries, the USA, and Japan.

Geography has a profound effect on the behavior and performance of investors. This behavioral model, which is affected by a bias known as "home bias" in the behavioral finance literature, can be effective on both individual and institutional investors. In other words, investors are more likely to hold and trade foreign stocks from countries with more economic and cultural ties (Portes and Rey 2005).

Based on capital market models, home bias began with French and Poterba's (1991) analysis of the USA, UK, and Japan, and was elaborated by Black (1974), Michaelides (2003), Stulz (1981a), and Stulz (1981b). The existence of a home bias tendency for the USA, England and Japan has been confirmed by numerous studies (Cooper and Kaplanis, 1994;

Fidora et al. 2007; Ivkovic and Weisbrenner, 2005; Coval and Moskowitz, 1999). Additional evidence for Germany, France, Italy, Finland, and Sweden documents the phenomenon's global reach (Anderson et al. 2011; Bodnaruk, 2009; Chan et al. 2005; Lau et al. 2010; Mishra 2015; Lippi 2016; Hong et al. 2005; Huberman 2001; Grinblatt and Keloharju 2001; Kang and Stulz 1997; Baltzer et al. 2013; Wójcik 2009). Home bias is also common for both individual investors and professional investors such as mutual fund managers (Shapira and Venezia 2001) or pension fund managers (Lippi 2016). However, individuals tend to exhibit a higher degree of bias (Ivkovic and Weisbenner 2005; Lütje and Menkhof 2007).

In terms of investors, their geographical proximity to the companies they plan to invest in may be important for reasons such as being able to reach company employees, managers, company suppliers, products and services more easily and learning information on these issues in a shorter time. It can also help assess intangible factors that affect stock prices, such as geographic proximity, management ability, corporate culture or local business environment (Gaspar and Massa 2007). On the other hand, investors who are geographically distant may not have local knowledge, but they can make up for it with investment expertise, knowledge of all corporate sectors and, global business conditions related to trade. Therefore, it would be wrong to reduce secondary stock markets to a war between local and non-local investors (Wójcik, 2009).

Another important question is whether the fact that cities are financial centers has any effect on investors and portfolio sizes. If a stock market is defined as a company that focuses solely on providing computer servers and software for trading, the answer is no (Wójcik, 2009).

### **Turkey's financial investment map**

The data was obtained from the "Central Registry Agency Data Analysis Platform" in the period of May 2022. The sample includes the number of domestic and foreign investors, current portfolio values, and the number of investors in 81 provinces.

İstanbul, Ankara, İzmir, Bursa, Antalya, Adana, Kocaeli, Balıkesir, Muğla and Aydın are among the top ten cities with the highest current portfolio value in May 2022. Considering the number of investors, the first seven cities were the same, while the last three cities were Muğla, Mersin, and Balıkesir (Table 1). The Kruskal Wallis test was used to analyze whether there are significant differences on the basis of provinces in terms of the current portfolio value and the number of current investors. According to the results, there is a significant difference between provinces in terms of portfolio value ( $H(80)=179.905$ ,  $p=.000$ ), but the number of investors does not differ significantly between provinces ( $p>.005$ ). Accordingly, the

cities with the highest portfolio size are İstanbul, Ankara, Kocaeli, Kayseri, Antalya, Muğla, and İzmir, respectively. These results are consistent with the cities included in the “BIST City Index”.

Table 1. Portfolio values and number of investors by province

Province	Percentage	Current Portfolio Value	Province	Percentage	Number of Investors in the Current Period						
İstanbul	65,65%	₺981.874.212.184,70	İstanbul	23,87%	1.358.487						
Ankara	16,11%	₺240.917.743.161,42	Ankara	9,68%	550.953						
İzmir	3,44%	₺51.459.010.031,01	İzmir	7,84%	446.274						
Bursa	1,99%	₺29.719.578.055,75	Bursa	3,97%	225.782						
Antalya	1,05%	₺15.761.280.726,74	Antalya	3,75%	213.339						
Adana	0,91%	₺13.648.555.715,97	Adana	2,54%	144.715						
Kocaeli	0,78%	₺11.670.751.584,85	Kocaeli	2,38%	135.187						
Balıkesir	0,71%	₺10.634.023.941,49	Muğla	2,10%	119.465						
Muğla	0,69%	₺10.289.696.530,70	Mersin	2,06%	116.949						
Aydın	0,63%	₺9.396.605.915,09	Balıkesir	2,03%	115.344						
Province	N	Mean Rank	Chi-Square	df	Asymp. Sig.	Province	N	Mean Rank	Chi-Square	df	Asymp. Sig.
İstanbul	31	991,77	179,91	80	0	İstanbul	31	763,74	45,705	80	0,999
Ankara	24	914,67				Ankara	24	732,67			
Kocaeli	20	844,95				Tekirdağ	15	719,13			
Kayseri	18	766,33				Antalya	20	709,55			
Antalya	20	760,3				Uşak	13	700,58			
Muğla	18	757,67				Isparta	14	697,29			
İzmir	24	754,9				Muğla	18	692,08			
Gaziantep	20	751,15				Aydın	18	689,72			
Bursa	22	739,41				Çanakkale	15	683,47			
Aydın	18	735,83				Nevşehir	12	670,21			
Yalova	14	733,79				Kayseri	18	670,19			
Konya	19	731,84				Kastamonu	13	664,27			
Zonguldak	18	716,56				Şanlıurfa	15	663,07			
Tekirdağ	15	716,47				İzmir	24	659,73			
Balıkesir	19	715,84				Bursa	22	657,48			
Hatay	17	702,94				Konya	19	655,63			
Isparta	14	698,79				Eskişehir	17	652,56			
Manisa	18	689,06				Kahramanmaraş	17	649,94			
Denizli	18	678,94				Giresun	13	649,54			
Eskişehir	17	674,41				Yozgat	13	648,23			

“City Indices” calculated since the beginning of 2009 consist of the shares of companies whose main production or activity center is in the same city. BIST City Indices are calculated for cities in which there are at least 5 companies traded in the Star Market, Main Market and Sub-Market. It is currently calculated for Adana, Ankara, Antalya, Aydın, Balıkesir, Bursa, Denizli, Istanbul, Izmir, Kayseri, Kocaeli, Konya and Tekirdag ([www.borsaistanbul.com](http://www.borsaistanbul.com)). The summary data of the provinces included in the city index are given in Table 2.

Table 2. Summary data of the provinces included in the city index

			Portfolio value per investor	
Assets class	Share	Portfolio Size	166.231.783.950,17	171.394,53
		Number of Investors	969.878,00	
	Fund	Portfolio Size	95.630.002.744,21	73.570,65
		Number of Investors	1.299.839,00	
	Government Domestic Debt Instruments	Portfolio Size	114.434.136.558,13	21.278.195,72
		Number of Investors	5.378,00	
	Private Sector Debt Instruments	Portfolio Size	23.565.114.283,96	1.250.603,10
		Number of Investors	18.843,00	
	Other Stocks and Bonds	Portfolio Size	4.832.013.129,35	2.014.178,05
		Number of Investors	2.399,00	
	Structured Products	Portfolio Size	57.080.976,24	10.053,01
		Number of Investors	5.678,00	
Nationality	Domestic	Portfolio Size	403.700.942.388,00	176.058,28
		Number of Investors	2.292.996,00	
	Foreigner	Portfolio Size	1.049.189.254,00	9.018,99
		Number of Investors	116.331,00	

It is seen that the most preferred asset class in the provinces included in the city index is share certificates, followed by government bonds. Despite this result, it is noteworthy that government domestic debt instruments rank first in portfolio value per investor. According to the nationalities of the investors, it is seen that the number of domestic investors is higher, consistent with the home bias tendency.

Istanbul, Ankara, İzmir, Bursa, Antalya, Adana, Kocaeli, Balıkesir, Muğla and Aydın are in the top ten cities ranking according to the current portfolio value of domestic investors. Istanbul ranks first in the average portfolio size per investor (Table 3). In the ranking of the current portfolio values of foreign investors, the top fifteen provinces are Istanbul, Antalya, Muğla, Ankara, İzmir, Aydın, Bursa, Kocaeli Mersin, Yalova, Adana, Iğdır, Konya, Balıkesir and Kayseri. In the average portfolio size per foreign investor, Iğdır ranks second with a total of twelve investors. This result

comes as a surprise for the markets, which are accustomed to seeing the western and metropolitan cities in the top positions in stock market investments (Table 3).

*Table 3. Status of domestic and foreign investors by province*

Province	Current Period Portfolio Value	Number of Investors in the Current Period	Average portfolio per investor
İstanbul	945.739.161.721,87	1.350.229	700.428,71
Ankara	240.775.931.004,89	549.334	438.305,17
İzmir	51.326.460.813,72	445.049	115.327,66
Bursa	29.662.330.706,25	225.192	131.720,18
Antalya	15.275.802.145,19	210.243	72.657,84
Adana	13.625.203.868,61	144.522	94.277,71
Kocaeli	11.628.513.409,03	134.934	86.179,27
Balıkesir	10.612.626.631,29	115.125	92.183,51
Muğla	10.027.605.476,16	117.568	85.291,96
Aydın	9.304.760.118,61	102.602	90.687,90
Mersin	7.476.795.951,62	116.669	64.085,54
Hatay	6.359.679.154,78	85.190	74.652,88
Gaziantep	6.242.658.921,66	70.254	88.858,41
Kayseri	6.120.850.940,89	70.264	87.112,19
Province	Current Period Portfolio Value	Number of Investors in the Current Period	Average portfolio per investor
İstanbul	36.135.050.462,83	8258	4.375.762,95
Antalya	485.478.581,55	3096	156.808,33
Muğla	262.091.054,54	1897	138.160,81
Ankara	141.812.156,54	1619	87.592,44
İzmir	132.549.217,29	1225	108.203,44
Aydın	91.845.796,48	1058	86.810,77
Bursa	57.247.349,50	590	97.029,41
Kocaeli	42.238.175,81	253	166.949,31
Mersin	24.001.975,01	280	85.721,34
Yalova	23.769.855,06	93	255.589,84
Adana	23.351.847,36	193	120.994,03
İğdır	22.055.249,26	12	<b>1.837.937,44</b>
Konya	21.438.290,16	236	90.840,21
Balıkesir	21.397.310,20	219	97.704,61
Kayseri	20.180.016,17	285	70.807,07

## **Discussion**

Financial markets not only reflect the economy and society, they also show how the economy and society work. The importance of these markets for the geography of the world economy is emphasized in the conditions of global financial turmoil. Topics such as the evolution of securities industry centers and the transformation of the global stock market map, which includes examining the changing role of individual cities as financial centers over time, are important areas of research. Because the examination of investments on a city basis is important in terms of the contribution of cities to the country's economy.

This study, which takes Turkey's financial geography as an example, emphasizes the importance of examining financial geographies not only at the global but also at the national level. Knowing their cities or states in terms of financial investments will be a leading indicator in the issuance of financial investment instruments. Due to the home bias of investors, it may be logical for companies in their own city to turn to stocks and debt instruments. However, in the presentation of government domestic debt instruments or funds, different supply strategies can be developed in each city or state. Additionally, businesses may find it appropriate to use various public offering tactics on a city or state basis if they believe there are less possible investors owing to population growth. This will enhance their funding sources. Ultimately, being able to market investment instruments is a new but extremely important topic in finance and marketing literature.

## REFERENCES

- Anderson CW, Fedenia M, Hirschey M, Skiba H (2011) Cultural influences on home bias and international diversification by institutional investors. *J Bank Financ* 35(4):916–934 <https://doi.org/10.1016/j.jbankfn.2010.09.006>
- Baltzer M, Stolper O, Walter A (2013) Is local bias a cross-border phenomenon? Evidence from individual investors' international asset allocation. *J Bank Financ* 37(8):2823–2835 <https://doi.org/10.1016/j.jbankfn.2013.04.009>
- Behrens, K. and Thisse, J.-F. (2007) 'Regional Economics: A New Economic Geography Perspective?' *Regional Science and Urban Economics*, Vol. 37, No. 4, pp. 457–465.
- Black F (1974) International capital market equilibrium with investment barriers. *J Financ Econ* 1(4):337–352 [https://doi.org/10.1016/0304-405X\(74\)90013-0](https://doi.org/10.1016/0304-405X(74)90013-0)
- Bodnaruk A (2009) Proximity always matters: local bias when the set of local companies changes. *Rev Financ* 13(4):629–656 <https://doi.org/10.1093/rof/rfp014>
- Chan K, Covrig VM, Ng L (2005) What determines the domestic bias and foreign bias? Evidence from mutual fund equity allocations worldwide. *J Financ* 60(3):1495–1534 [https://doi.org/10.1111/j.1540-6261.2005.768\\_1.x](https://doi.org/10.1111/j.1540-6261.2005.768_1.x)
- Clark, G. L., & Wójcik, D. (2005) 'Path Dependence and Financial Markets: The Economic Geography of The German Model, 1997–2003'. *Environment and Planning A*, Vol. 37, No. 10, pp. 1769–1791.
- Clark, G. L., and Wójcik, D. (2007) 'The Geography of Finance: Corporate Governance in the Global Marketplace'. Oxford University Press, Oxford.
- Clark, G.L. (2002) 'London in the European Financial Services Industry: Locational Advantage and Product Complementarities'. *Journal of Economic Geography*, Vol. 2, No. 4, pp. 433–453.
- Clark, G.L., Wójcik, D. and Bauer, R. (2006) 'Geographically Dispersed Ownership and Inter market Stock Price Arbitrage. Ahold's Crisis of Corporate Governance and its Implications for Global Standards'. *Journal of Economic Geography*, Vol. 6, No. 3, pp. 303–322.
- Cooper IA, Kaplanis E (1994) Home bias in equity portfolios, inflation hedging, and international capital market equilibrium. *Rev Financ Stud* 7(1):45–60 <https://doi.org/10.1093/rfs/7.1.45>
- Coval JD, Moskowitz TJ (1999) Home bias at home: local equity preference in domestic portfolios. *J Financ* 54(6):2045–2073 <https://doi.org/10.1111/0022-1082.00181>
- Engelen, E. and Grote, M.H. (2009) 'Stock Exchange Virtualisation and The Decline of Second-tier Financial Centres—The Cases of Amsterdam and Frankfurt'. *Journal of Economic Geography*, Vol. 9, No. 5, pp. 679–696.

- Fidora M, Fratzscher M, Thimann C (2007) Home bias in global bond and equity markets: the role of real exchange rate volatility. *J Int Money Financ* 26(4):631–655 <https://doi.org/10.1016/j.jimonfn.2007.03.002>
- French KR, Poterba JM (1991) Investor diversification and international equity markets. *Am Econ Rev* 81(2):222–226 <http://www.jstor.org/stable/2006858>
- Garretsen, H. and Martin, R. (2010). Rethinking (New) Economic Geography Models: Taking Geography and History More Seriously. *Spatial Economic Analysis* 5(2), 127–160.
- Gaspar, J.-M., and Massa, M. (2007). Local ownership as private information: evidence on the monitoring-liquidity trade-off. *Journal of Financial Economics* 83, pp. 751–92.
- Grinblatt M, Keloharju M (2001) How distance, language, and culture influence stockholdings and trades. *J Financ* 56(3):1053–1073 <https://doi.org/10.1111/0022-1082.00355>
- Halling, M., et al. (2007). Where is the market? Evidence from cross-listings in the United States. *Review of Financial Studies*. Advance access publication retrieved on 19 December 2008 from <http://rfs.oxfordjournals.org/cgi/content/abstract/hhm066v1>
- Hong H, Kubik JD, Stein JC (2005) Thy neighbor's portfolio: word-of-mouth effects in the holdings and trades of money managers. *J Financ* 60(6):2801–2824 <https://doi.org/10.1111/j.1540-6261.2005.00817.x>
- Huberman G (2001) Familiarity breeds investment. *Rev Financ Stud* 14(3):659–680 <https://doi.org/10.1093/rfs/14.3.659>
- Ivkovic Z, Weisbenner S (2005) Local does as local is: information content of the geography of individual investors' common stock investments. *J Financ* 60(1):267–306 <https://doi.org/10.1111/j.1540-6261.2005.00730.x>
- Kang J-K, Stulz RM (1997) Why is there a home bias? An analysis of foreign portfolio equity ownership in Japan. *J Financ Econ* 46(1):3–28 [https://doi.org/10.1016/S0304-405X\(97\)00023-8](https://doi.org/10.1016/S0304-405X(97)00023-8)
- Klagge, B. and Martin, R. (2005) 'Decentralized versus Centralized Financial Systems: Is There a Case for Local Capital Markets?' *Journal of Economic Geography*, Vol. 5, No. 4, pp. 387–421.
- Krugman, P. (1998) 'What's New About The New Economic Geography?' *Oxford Review of Economic Policy*, Vol. 14, No. 2, pp. 7–17.
- Lau ST, Ng L, Zhang B (2010) The world price of home bias. *J Financ Econ* 97(2):191–217 <https://doi.org/10.1016/j.jfneco.2010.04.002>
- Lee, R., Clark, G.L., Pollard, J. and Leyshon, A. (2009) 'The Remit of Financial Geography— Before and After The Crisis'. *Journal of Economic Geography*, Vol. 9, No. 5, pp. 723– 747.



- Lippi A (2016) (Country) Home bias in Italian occupational pension funds asset allocation choices. *Q Rev Econ Financ* 59:78–82 <https://doi.org/10.1016/j.qref.2015.07.001>
- Loughran, T., and Schultz, P. (2006). Asymmetric information, firm location, and equity issuance. Working Paper retrieved on 19 December 2008 from <http://leeds-faculty.colorado.edu/yungc/Seminar%20Papers/location.pdf>
- Lütje T, Menkhof L (2007) What drives home bias? Evidence from fund managers' views. *Int J Financ Econ* 12(1):21–35 <https://doi.org/10.1002/ijfe.309>
- Martin, R. (1999) 'Critical Survey. The New 'Geographical Turn' in Economics: Some Critical Reflections'. *Cambridge Journal of Economics*, Vol. 23, No. 1, pp. 65–91.
- Martin, R. (2011) 'The Local Geographies of The Financial Crisis: From The Housing Bubble to Economic Recession and Beyond'. *Journal of Economic Geography*, Vol. 11, No. 4, pp. 587–618.
- Michaelides A (2003) International portfolio choice, liquidity constraints and the home equity bias puzzle. *J Econ Dyn Control* 28(3):555–594 [https://doi.org/10.1016/S0165-1889\(03\)00035-6](https://doi.org/10.1016/S0165-1889(03)00035-6)
- Mishra AV (2015) Measures of equity home bias puzzle. *J Empir Financ* 34:293–312 <https://doi.org/10.1016/j.jempfin.2015.08.001>
- Peck, J. and Theodore, N. (2007) 'Variegated Capitalism'. *Progress in Human Geography*, Vol. 31, No. 6, pp. 731–772.
- Portes, R., and Rey, H. (2005). The determinants of cross-border equity flows. *Journal of International Economics* 65, pp. 269–296.
- Sarkissian, S. and M.J. Schill (2004) The overseas listing decision: New evidence of proximity preference *Review of Financial Studies*, 17, 769-809
- Shapira Z, Venezia I (2001) Patterns of behavior of professionally managed and independent investors. *J Bank Financ* 25(8):1573–1587 [https://doi.org/10.1016/S0378-4266\(00\)0013](https://doi.org/10.1016/S0378-4266(00)0013)
- Stulz RM (1981a) A model of international asset pricing. *J Financ Econ* 9(4):383–406 [https://doi.org/10.1016/0304-405X\(81\)90005-2](https://doi.org/10.1016/0304-405X(81)90005-2)
- Stulz RM (1981b) On the effects of barriers to international investment. *J Financ* 36(4):923–934 <https://doi.org/10.1111/j.1540-6261.1981.tb04893.x>
- Wójcik, D. (2007) 'Geography and Future of Stock Exchanges: Between Real and Virtual Space'. *Growth and Change*, Vol. 38, No. 2, pp. 200–223.
- Wójcik, D. (2008a). Financial centre bias: another puzzling anomaly in the IPO market? Retrieved on 19 December 2008 from [http://papers.ssrn.com/sol3/papers.cfm?abstract\\_id=1145223](http://papers.ssrn.com/sol3/papers.cfm?abstract_id=1145223)
- Wójcik, D. (2009) 'Geography of Stock Markets'. *Geography Compass*, Vol. 3, No. 4, pp. 1499–1514.

Yeung, H.W.C. and Kelly, P. (2007) 'Economic Geography: A Contemporary Introduction'. John Wiley & Sons.

<https://www.borsaistanbul.com/tr/sayfa/164/sehir-endeksleri> (Access: 19.07.2022)

“

## Chapter 5

**THE INFLUENCE OF DOGMATISM ON  
CONSUMER PREFERENCES IN REGARD  
TO CONSUMER ETHNOCENTRISM**

*Ulvi Cenap TOPÇU<sup>1</sup>*

”

---

<sup>1</sup> Phd., Research Assistant, Çanakkale Onsekiz Mart University, ulvicenap@gmail.com, 0000-0001-6301-2357

## Introduction

Consumption patterns can be associated with several factors like social group norms, identification, feelings towards the homeland, kinship, or belief systems, which may also be credited antecedents of particular consumer preferences. These mind-sets are scholarly investigated from different viewpoints in consumer studies, country-of-origin and consumer ethnocentrism concepts serve theoretical bases concerning rationalization of aforementioned notions. Many scholars attempt to investigate cognitive and behavioural inferences concerning the concepts; nonetheless, consumer ethnocentrism and its relations are not yet decently lighted in the literature.

Solely, Al Ganideh, El Rafae, & Al Ganideh (2011) expounded the relevance of dogmatism and consumer ethnocentrism by statistically demonstrating the antecedent role of the dogmatic character attribute. Recognizing the affinity of two concepts, it is also possible to determine further relations and acquire theoretical conclusions in terms of cognitive and behavioural differences. Within this context, as a contribution to the scholarly efforts, it is aimed to empirically examine the aspects of the relationships between dogmatism and consumer ethnocentrism, domestic product judgment and reluctance to buy foreign products. The paper first describes the concepts and how they are approached. Next, the methodological setup of the survey is clarified. Finally, the results are presented and discussed, and new routes for further research are suggested.

## Conceptual Framework

Consumption behaviour without “valid” economical explanation was inferred to be exceptional by early scholars. For example Leibenstein (1950) put together a solid classification of consumption types in which he postulated “rational” base of consumption and excluded “the non-rational” on the trail of classic economists. Categories of consumption determined by him dealt with economic function initially, yet the “non-functional” aspects were eventually addressed. Eventually scholars were to lay stress on “the undiscussed”, and further interpretations were to come. Abandoning the early economic approaches led the scholars to implicitly discuss rational explanations of consumer behaviour; with social construction of consumption patterns (Bourdieu, 1984; Baudrillard, 2016), class struggle (Featherstone, 2005, 148), and more recently, biological perspectives as relating consumer choice with natural and sexual selection cues (Miller, 2009).

Japutra and Song (2020: 424) stressed the importance of examining “different psychological drivers (such as fixed and growth mindsets) behind consumer motivations” to understand how consumer behaviours

are influenced. In this paper, dogmatism, a philosophic term referred to a sentiment of mind set is aimed to be associated with country-of-origin related concepts to detect insights into conservationist consumer behaviour. Since the terms may bear slightly different meanings in the literature, in this section, consumer ethnocentrism tendency, domestic product judgment and reluctance to buy foreign products as the factors associated in the study are briefly addressed to clarify how the paper approaches them.

### **Dogmatic attitudes**

Rokeach (1960) explained dogmatism as narrow understanding of things in terms of organization of beliefs and disbeliefs. This leads the individual to decide what is true or false; what is right or wrong. Moreover, the attitudes by these judgments do not need any rational justification; the only justification would be the prevailing belief itself (Christensen, 1994: 69). In this sense, dogmatic view, associated with political beliefs (van Prooijen & Krouwel, 2016), ideologically emerges intolerance towards certain actions. Such precision and intolerance may determine individual's choices; thereby affect preferences in consumer behaviour. Thusly, the consumer makes, or tends to make, concrete choices pursuant to beliefs, values, or premises, since there is no grey area to justify any other option.

In previous studies, Bruning, Kovacic and Oberdick (1985) engaged dogmatic personality trait factor as a predictor in “domestic airline passenger market”; Caruana and Magri (1996) and Al Ganideh *et al.* (2011) related the concept to consumer ethnocentrism as a character attribute which infers a strict understanding of reality. Therefore, dogmatism is regarded as the consumers' assurance of beliefs, information and feelings towards things in life. To measure the phenomena, the dogmatism scale used in Al Ganideh *et al.* (2011) is adopted, which was originally taken from the five items Bruning *et al.* (1985) marked to have highest factor loadings of dogmatism construct. Hence, in this study, dogmatic attitude is associated with its impact on conservative consumption intentions.

### **Consumer Ethnocentrism Tendency**

Following Sumner's (1911) ethnocentrism concept, Shimp and Sharma (1987) put forth consumer ethnocentrism concept which implicates individual's tendency to favour own group in terms of economic activities. As the tendency to view the world from the perspective of group solidarity via consumption, the term refers to attesting in-group product favouring instead of foreign product choices. The strength of the rationale of in-group consumption, thus, enriches the bonds and membership to the society, by protecting the economy and performing “the required duty”.

Consumer ethnocentrism has the sense of being a good member of the society by supporting the national economy even if domestic products are somewhat less economically favourable than foreign substitutes (Hopkins & Powers, 2007; Lantz & Loeb, 1996). From this point of view, supporting the in-group economy regardless of the “nature” of the transaction sets an example of dogmatic understanding of in-group solidarity. Therefore, dogmatic attitudes reasonably have impact on ethnocentric consumption. In other words, ethnocentric consumers are likely to have the dogmatic belief on the necessity for supporting the national economy by preferring national products over foreign products. Al Ganideh *et al.* (2011) examined consumer ethnocentrism with its alleged relationship with dogmatism. In their study, dogmatism was documented to be highly related with consumer ethnocentrism. Hereby in this research, it is collinearly argued that dogmatic attitudes are positively related to consumer ethnocentrism tendency.

H1. Dogmatism is positively related to consumer ethnocentrism.

### **Domestic product judgment**

Consumers may evaluate products according to origin countries where they are produced or the brand was labelled with (Bernard, Collange, Inagaro, & Zarrouk-Karoui, 2020; Dimitrovic & Vida, 2010; Lopez & Balabanis, 2021). It is also documented that consumers may appreciate products from a specific country or domestic products based on cultural and capital assets of different nations (Asil & Kaya, 2013; Han & Won, 2018; Wang & Chen, 2004). The consumer may have opinions for specific products due to origin country, and likewise their judgment may change the consequences of their opinions on product choices (Shankarmahesh, 2006). The notion of country-of-origin is used to explain such insights in the literature (Lantz & Loeb, 1996), and related to ethnocentric tendencies when domestic product perceptions are investigated, meaning that it is anticipated that ethnocentric tendencies also influence consumer judgment on domestic products.

Ethnocentric consumption tendencies are not always in line with domestic product judgment or further inferences (Topçu, 2014). Perceptions may be determined by product experiences, personal interests, or market specifications. Consumer choices may differ according to various other factors including cultural differences, “country-level factors” (Han & Won, 2018), or perceived “foreign threat” (Jo, 1998). Nevertheless, it is likely for ethnocentric consumers to favour domestic products and have more positive judgments in general. Ethnocentric consumer is likely to justify domestic product choices to protect national economy; promote the

sentiment of protection to all members of the society, and invite them to share the positive judgment which is for the common good. Therefore, a significant positive relationship between consumer ethnocentrism tendency and domestic product judgment is expected.

H2. Consumer ethnocentrism is positively related to domestic product judgment.

### **Reluctance to buy foreign products**

Product choices are influenced by various factors leading the consumer to also develop diverse intentions, intolerance or reluctance towards products by perceived features. Origin country may be an important feature the consumer interacts with, but also consumer may form the distinction differently and being labelled “foreign” may be enough to form the action of the consumer. Due to commitment to protecting the national economy, group solidarity or opposing the other; the consumer may intent to resist purchasing foreign products categorically. Klein, Ettenson, & Morris (1998) refined this intention as “willingness to buy” Japanese goods in their research on the effect of war animosity on Japanese product choices. Based on this, the suggested factor “reluctance to buy foreign products” refers to the extent the consumer avoids foreign product choices, which implies a different set of meaning than purchasing domestic products.

The consumers’ desire to stand by national economy is thusly expected to affect consumption choices resistant to foreign goods. Therefore, consumer ethnocentrism tendency is expected to be positively related to reluctance to buy foreign products.

H3. Consumer ethnocentrism is positively related to reluctance to buy foreign products.

Ethnocentric consumer tendencies entail positive judgments on domestic products to rationalize product choices. Either implicitly or explicitly, the consumer may tend to favour domestic products from a nationalistic viewpoint. In this sense, positive national product justification has positive effect on the extent consumer ethnocentrism to induce resistance to purchasing foreign products. Therefore, it is expected to measure mediation of domestic product judgment on the relationship between consumer ethnocentrism and reluctance to buy foreign products; thereby more positive justification of domestic products mean more reluctance to buy foreign products.

H4. Domestic product judgment mediates the relationship between consumer ethnocentrism and reluctance to buy foreign products.

Anderson & Cunningham (1971) reported that lower levels of

dogmatism relates with more favourable attitudes towards foreign products. Even though, Nakip & Gökmen (2017) question the “wisdom” behind avoiding foreign products when mentioning the relationship between dogmatism and consumer ethnocentrism; it may still be argued that when the consumer has the strong sense of right and wrong, this would also induce stronger negative intentions towards foreign goods for ethnocentric consumers. In other words, it is argued that, higher levels of dogmatism cause higher levels of intolerance for purchasing foreign labelled goods. Hence, it is expected that dogmatism is positively related to reluctance to buy foreign products.

H5. Dogmatism is positively related to reluctance to buy foreign products.

## **Methodology**

Survey methodology is used to gather data to test the hypotheses using structural equation modelling (SEM). The survey questionnaire was combined as 5-point Likert form, with choices ranging from “1” for “disagree”, “3” for “mildly agree” and “5” for “definitely agree”. The items were rewritten in Turkish by adapting dogmatism scale from Al Ganideh *et al.* (2011); adapting a 6-item short version of Shimp & Sharma’s (1987) CETSCALE (consumer ethnocentrism tendency scale), product judgment scale and reluctance to buy foreign products scale from Klein *et al.* (1998) (see Appx. 1). The latter was originally named “willingness to buy” scale, and rewritten in context to the study by changing the items as mentioned above. For instance the first item of “reluctance to buy foreign products” factor was changed to “İthal bir ürün satın alsam kendimi suçlu hissederim. [I would feel guilty if I bought an imported product.]” from the original item “I would feel guilty if I bought a Japanese product.” in Klein *et al.* (1998). It may also be worth to mention that product judgment and reluctance to buy/willing to buy scales had been adapted by the authors from the scales in Darling & Arnold (1988) which longitudinally investigated practical significance of country of origin effects of different product sets in the Finnish market, noting significant aspects of the phenomena.

The questionnaire included demographic questions to check the dispersion of the sample and scrutinize possible inferences of participants’ gender, age, occupation and monthly income. The survey was directed online to members of a university in Turkey in 2019 with an invitation note specifying the aim of the study.



**Table I: Demographics**

		<b>Freq.</b>	<b>%</b>
<b>Gender</b>	Female	158	51.1
	Male	151	48.9
<b>Age</b>	25 and less	139	45
	26 to 35	80	25.9
	36 to 45	53	17.2
	46 to 55	32	10.4
	56 and more	5	1.6
<b>Occupation</b>	Academic staff	89	28.8
	Administrative personnel	73	23.6
	Student	147	47.6
<b>Monthly income</b>	Less than 3000 TL	152	49.2
	3000 to 5999 TL	120	38.8
	6000 to 8999 TL	25	8.1
	9000 to 11999 TL	8	2.6
	12000 TL and more	4	1.3
<b>Total</b>	N	309	100

The sample consists of 309 participants who responded the invitation, as presented in **Table I**. The demographic statistics suggest a proper dispersion compared to the total population of the target university.

**Table II: Item loadings**

			<b>Std. Est.</b>	<b>Estimate</b>	<b>S.E.</b>	<b>C.R.</b>	<b>P</b>
judg1	<---	PJ	.849	1.000			
judg2	<---	PJ	.813	.974	.056	17.530	***
judg3	<---	PJ	.759	.846	.054	15.779	***
judg4	<---	PJ	.918	1.058	.049	21.371	***
judg5	<---	PJ	.803	.932	.054	17.196	***
rel1	<---	RtBFP	.790	1.000			
rel2	<---	RtBFP	.792	.908	.063	14.462	***
rel3	<---	RtBFP	.746	1.174	.087	13.500	***
rel4	<---	RtBFP	.729	.933	.071	13.146	***
rel5	<---	RtBFP	.730	1.111	.084	13.155	***
rel6	<---	RtBFP	.413	.726	.104	7.008	***
dog1	<---	Dogm	.433	1.000			
dog2	<---	Dogm	.682	1.649	.243	6.786	***
dog3	<---	Dogm	.839	1.855	.258	7.179	***
dog4	<---	Dogm	.750	1.594	.228	7.007	***
dog5	<---	Dogm	.598	1.390	.216	6.433	***
etn1	<---	CETa	.378	1.000			
etn2	<---	CETa	.689	1.523	.259	5.881	***
etn3	<---	CETa	.740	1.856	.310	5.988	***

			Std. Est.	Estimate	S.E.	C.R.	P
etn4	<---	CETa	.787	2.085	.344	6.057	***
etn5	<---	CETb	.796	1.000			
etn6	<---	CETb	.843	1.061	.097	10.928	***
CETa	<---	CET	.815	1.000			
CETb	<---	CET	.760	1.904	.384	4.965	***

\*\*\* $p < 0.001$ , italics extracted

## Confirmatory Factor Analysis

Confirmatory factor analysis (CFA) was performed and revealed a validity problem for the model concerning consumer ethnocentrism tendency (CET). The analysis forced a second order constructing of the factor: CET was divided into two sub-dimensions as CETa and CETb. After extracting an item loading on dogmatism (dog1), an item loading on CETa (etn1), and an item loading on reluctance to buy foreign products (rel6) due to low factor loadings (see **Table II**), factor analysis was performed once more and model constructs are thereby confirmed. The reliability measures are accepted as: composite reliability CR=0.917 for domestic product judgment, CR=0.871 for reluctance to buy foreign products, CR=0.81 for dogmatism, and CR=0.785 for consumer ethnocentrism tendency (see **Table III**).

Concerning the validity, average variance extracted (AVE) values are measured over the 0.5 threshold and maximum shared variance (MSV) values indicate that the square of the highest correlation coefficient between latent constructs are lower than AVE values which ensures parent factor-item variable correlation accuracy (Hair, Black, Babin, & Anderson, 2010): AVE=0.689 and MSV=0.241 for domestic product judgment, AVE=0.575 and MSV=0.430 for reluctance to buy foreign products, AVE=0.521 and MSV=0.058 for dogmatism, and AVE=0.646 and MSV=0.430 for consumer ethnocentrism tendency (see **Table III**). Model fit values presented in **Table IV** are  $\chi^2/df = 1.601$  (excellent), CFI = 0.7 (excellent), SRMR = 0.043 (excellent), RMSEA = 0.044 (excellent) and PClose = 0.815 (excellent). Therefore, reliability, validity and model fit values confirm the constructs and enable passing through to path analysis to test the hypotheses.

**Table III:** *Validity and Reliability Measures*

	CR	AVE	MSV	MaxR(H)	PJ	RtBFP	Dogm	CET
<b>PJ</b>	0.917	0.689	0.241	0.929	<b>0.830</b>			
<b>RtBFP</b>	0.871	0.575	0.430	0.874	0.491***	<b>0.758</b>		
<b>Dogm</b>	0.810	0.521	0.058	0.846	0.047	0.019	<b>0.722</b>	
<b>CET</b>	0.785	0.646	0.430	0.790	0.408***	0.656***	0.241**	<b>0.804</b>

\* $p < .05$ , \*\* $p < .01$ , \*\*\* $p < .001$ , italics non-significant

**Table IV: Model Fit Values**

Measure	CMIN	DF	CMIN/DF	CFI	SRMR	RMSEA	PClose
Estimate	230.499	144	1.601	0.970	0.043	0.044	0.815
<b>Interpretation -</b>	-	-	Excellent	Excellent	Excellent	Excellent	Excellent

## Path Analysis

Path analysis was performed to test the hypotheses, and results are as follows and as presented in **Table V**: Dogmatism is significantly related to CET ( $\beta=.241$ ,  $p<.01$ ), H1 is supported. CET is measured to be related to domestic product judgment ( $\beta=.421$ ,  $p<.01$ ), H2 is supported. The results reveal that CET is also significantly related to reluctance to buy foreign products ( $\beta^i=.692$ ,  $p<.01$ ) and this relationship is partially mediated by domestic product judgment since significant indirect effect is revealed ( $\beta^i=.109$ ,  $p<.01$ ), therefore H3 and H4 are supported. Erratically, the relationship between dogmatism and reluctance to buy foreign products is found significant in direct effects but an unexpected negative relationship is measured ( $\beta^d=-.134$ ,  $p<.05$ ). Moreover, the total effect measured for this relationship is not significant, when the analysis shows positive indirect effect ( $\beta^i=.102$ ,  $p<.05$ ). Consequently, H5 is not supported and the results do not reveal explanation for this relationship, therefore merely necessity of further inquisition emerged.

The analyses were conducted to test possible demographic results, yet no significant result was achieved, conceivably due to inadequate sample size. Therefore, these results are not presented.

**Table V: Path analysis**

			S.E.	C.R.	Std. Direct	Std. Total	H
CET	<---	Dogm	.060	3.078	.241**	.241**	H1
PJ	<---	Dogm	.072	-.836	-.054	.047	-
PJ	<---	CET	.124	4.950	.421***	.421**	H2
RtBFP	<---	CET	.127	5.804	.583***	.692**	H3
RtBFP	<---	PJ	.056	4.034	.259***	.259**	H4
RtBFP	<---	Dogm	.058	-2.227	-.134*	.019	H5

\* $p<.05$ , \*\* $p<.01$ , \*\*\* $p<.001$ , italics non-significant

## Conclusion

The paper aimed to investigate influence of dogmatism on conservative product preferences in country of origin contexts. The findings revealed that dogmatic attitude has significant effect on consumer ethnocentrism

tendency (H1), consistent with the literature (Al Ganideh *et al.*, 2011; Caruana & Magri, 1996). Thus, dogmatism is inferred as an emerging factor for politically influenced consumption disposition, the consumer ethnocentrism. Therefore, the consumer with strict understanding of how to perceive and relate with the world also has the tendency to have strict belief on conservative economic manners in terms of consumption. Nonetheless, this strictness does not seem to be as effective on behavioural level, since the relationship of dogmatism and reluctance to buy foreign products factors is not found significant (H5). When the consumer with dogmatic characteristics also has the sense of conservatism in consumption, this was found to be effective on cognitive level. Behavioural aspects of such conservatism did not transpire in terms of having intention to avoid purchasing foreign products.

Even though, the effect of consumer ethnocentrism on reluctance to buy foreign products is significant as expected (H3), and dogmatism is a valid factor on consumer ethnocentrism; the results did not reveal that dogmatism have a part on consumer's ethnocentric resistance to foreign products. It is an intriguing finding that when people with dogmatic attitudes are more prone to ideals of economic conservatism in consumption, it does not seem to necessarily concretize in against of foreign goods. Therefore, it is deduced that dogmatism, even when raising ethnocentric tendencies, does not always influence the consumer behaviour in terms of avoiding foreign products. This result supports observed need of separation of cognitive and behavioural inferences of the concepts, as stated in Herche (1992) and Topçu (2014); since due to various factors, such as brand perceptions (Bernard *et al.*, 2020), consumers with ethnocentric intentions do not always act accordingly, or not every domestic consumption diligence is composed of ethnocentrism. Mentioning the question of significance of country of origin effects in consumer studies, Han (2020) discusses the impact of perception of brands in terms of brand quality, "globalness", and market characteristics. Also, Lopez and Balabanis (2021) present interrelations of country of origin, country image and brand and product types. It is inferred in this study that being influenced by ethnocentric intentions, consumers also pay regard to different aspects of products, or, the impact of these agents function in cognitive or behavioural levels at the same time and have different impacts on consumer behaviour.

Ethnocentric consumption tendencies are found to be significantly related to favouring domestic products (H2) by judging them more positively, and being prone to avoid foreign products (H4). These findings accord with the literature, as explained by protecting the in-group economy (Mangnale, Potluri, & Degufu, 2011) and practicing the bonds with and membership of the in-group (Shankarmahesh, 2006; Dimitrovic & Vida 2010).

Using all sources of information is essential to procure business success, yet all the factors related are not under management control. Nonetheless, identifying the parameters for foreseeing outcomes of marketing efforts and how to make use of them is important for professionals. This paper sets an example to contribute to scholarly efforts in the consumer behaviour studies, and further aspects would help marketers in determining consumers' behaviours. The findings and conclusions have limited claim for generalization on universal or national level. Due to ease of data gathering, the sample was limited to a university sphere. The results may differ with different sampling, and further research can be conducted by associating the factors to clear the phenomena further. The scholars are kindly invited to examining the concepts with possible different constructs, approaches, methodology, sampling, product types and focusing on cognitive-behavioural inferences.

*Appendix 1: Scale items and Turkish versions used in the questionnaire*

Original items considered	Adapted Turkish version used
<b>Dogmatism (Al Ganideh et al., 2011)</b>	
dog1 I am not very insistent in an argument. (R)	İnatçı bir tartışmacı değilimdir. (R)
dog2 I do everything in my power in order not to have to admit defeat.	Tartışmada yenilgiyi kabul etmemek için elimden geleni yaparım.
dog3 People find it difficult to convince me that I am wrong on a point no matter how hard they try.	Bir tartışmada haksız olduğumu kabul ettirmek, ne kadar çaba gösterilirse gösterilsin çok zordur.
dog4 I would get into a long discussion rather than admit that I am wrong.	Hatalı olduğumu kabul etmektense uzun tartışmalara girerim.
dog5 When someone opposes me on an issue, I usually find myself taking an even stronger stand than I did at first.	Birisi bana karşı çıktığında, o konudaki fikirlerim daha da güçlenir.
<b>Consumer ethnocentrism (Klein et al., 2008)</b>	
etn1 We should buy from foreign countries only those products that we cannot obtain with our own country.	Sadece kendi ülkemizde üretmediğimiz ürünleri yabancı ülkelerden satın almalıyız.
etn2 We should purchase products manufactured in China instead of letting other countries get rich off of us.	Başka ülkelerin bize mal satarak zengin olmasına izin vermek yerine yerli ürünler satın almalıyız.
etn3 Chinese products, first, last, and foremost.	Bence en önce, sonra ve her zaman yerli malı ürünler gelir.
etn4 It is not right to purchase foreign products, because it puts Chinese out of work.	Yabancı ürünler satın almamalıyız, çünkü bu yerli ekonomiye zarar verir ve işsizliğe neden olur.
etn5 Chinese consumers who purchase products made in other countries are responsible for putting their fellow Chinese out of work.	Yabancı malları satın alanlar ülkemizdeki işsizlikten sorumludurlar.
etn6 Purchasing foreign-made products is un-Chinese.	Yabancı ürünler satın almak Türklüğe yakışmaz.
<b>Reluctance to buy foreign products (Klein et al., 2008)</b>	
rel1 I would feel guilty if I bought a Japanese product.	İthal bir ürün satın alsam kendimi suçlu hissederim.
rel2 I would never buy a Japanese car.	Asla ithal ürün satın almam.
rel3 Whenever it is possible, I avoid buying Japanese products.	İthal bir ürün satın almaktan mümkün olduğunca kaçınıyorum.
rel4 Whenever it is possible, I prefer to buy products made in Japan. (R)	Uygun olduğunda ithal ürün satın almayı tercih ederim. (R)
rel5 I do not like the idea of owning Japanese products.	İthal ürünlere sahip olma fikrinden hoşlanmıyorum.
rel6 If two products are equal in quality, but one was from Japan and one was from China, I would pay 10% more for the product from China.	Kalite açısından eşit bir yabancı bir Türk araba varsa, Türk malı olana %10 daha fazla ederim
<b>Domestic product judgment (Klein et al., 2008)</b>	
judg1 Products made in Japan are carefully produced and have fine workmanship.	Yerli ürünler dikkatlice üretilmiş ve iyi işçiliğe sahip ürünlerdir.
judg2 Products made in Japan are generally of a lower quality than similar products available from other countries.(R)	Yerli ürünler genellikle başka ülkelerde üretilmiş benzer ürünlere göre daha düşük kaliteye sahiptir. (R)
judg3 Products made in Japan usually show a very clever use of color and design.	Yerli ürünler genellikle zarif renk ve tasarımlara sahiptir.
judg4 Products made in Japan are usually quite reliable and seem to last the desired length of time.	Yerli ürünler genellikle oldukça güvenilir ve dayanıklıdır.
judg5 Products made in Japan are usually a good value for the money.	Yerli ürünler genellikle verilen parayı hak eder.

(R) Reverse scored items.

## REFERENCES

- Al Ganideh, S. F., El Rafae, G. & Al Ganideh, A. O. (2011). Are Jordanian Patients Ethnocentric Toward Their National Pharmaceutical Products? An Empirical Investigation Following to the Arab Spring Uprisings. *Journal of US-China Public Administration*, 8(12), 1339-1351.
- Asil, H. & Kaya, İ. (2013). Türk Tüketicilerin Etnosentrik Eğilimlerinin Belirlenmesi Üzerine Bir Araştırma [An empirical study on determining ethnocentric tendencies of Turkish consumers]. *İstanbul Üniversitesi İşletme Fakültesi Dergisi*, 42(1), 113-132.
- Baudrillard, J. (2016). *Tüketim Toplumu: Söylenceleri Yapıları* [The Consumer Society: Myths and Structures]. Istanbul: Ayrıntı.
- Bernard, Y., Collange, V., Ingarao, A. & Zarrouk-Karoui, S. (2020). Products labeled as “made in domestic country”: the brand matters. *European Journal of Marketing*, 54(12), 2965-2987.
- Bourdieu, P. (1984). *Distinction: A Social Critique of The Judgement of Taste*. Cambridge Massachusetts: Harvard University Press.
- Bruning, E. R., Kovacic, M. L. & Oberdick, L. E. (1985). Segmentation Analysis of Domestic Airline Passengers Markets. *Journal of the Academy of Marketing Science*, 13(1-2), 17-31. <http://dx.doi.org/10.1007/BF02729703>
- Caruana, A. & Magri, E. (1996). The effects of dogmatism and social class variables on consumer ethnocentrism in Malta. *Marketing Intelligence & Planning*, 14(4), 39-44.
- Christensen, D. (1994). Conservatism in epistemology. *Noûs*, 28(1), 69-89.
- Darling, J.R. & Arnold, D.R. (1988). The competitive position abroad of products and marketing practices of the United States, Japan, and selected European countries. *Journal of Consumer Marketing*, 5, 61-68.
- Dimitrovic, T. & Vida, I. (2010). Consumer Behaviour Induced by Product Nationality: The Evolution of the Field and Its Theoretical Antecedents. *Transformations in Business & Economics*, 9(1), 145-165.
- Featherstone, M. (2005). *Postmodernizm ve Tüketim Kültürü* [Postmodernism and Consumption Culture]. Istanbul: Ayrıntı.
- Han, C. M. (2020). Assessing the predictive validity of perceived globalness and country of origin of foreign brands in quality judgments among consumers in emerging markets. *Journal of Consumer Behaviour*, 19, 463-480.
- Han, C. M. & Won, S. B. (2018). Cross-country differences in consumer cosmopolitanism and ethnocentrism: A multilevel analysis with 21 countries. *Journal of Consumer Behaviour*, 17, 52-66.
- Hair, J., Black, W. C., Babin, B. J. & Anderson, R. E. (2010). *Multivariate data analysis (7th ed.)*. Upper Saddle River, New Jersey: Pearson Education International.

- Herche, J. (1992). A Note on the Predictive Validity of the CETSCALE. *Journal of the Academy of Marketing Science*, 20(3), 261-264.
- Hopkins, R. A. & Powers, T. L. (2007). 'Buy National' and Altruistic Market Segments. *Journal of Global Marketing*, 20(4), 73-87.
- Japutra, A. & Song, Z. (2020). Mindsets, shopping motivations and compulsive buying: Insights from China. *Journal of Consumer Behavior*, 19, 423-437.
- Jo, M.S. (1998). Contingency and contextual issues of ethnocentrism-pitched advertisements: A cross-national comparison. *International Marketing Review*, 15(6), 447-457.
- Klein, J. G., Ettenson, R. & Morris, M. D. (1998). The animosity model of foreign product purchase: An empirical test in the People's Republic of China. *Journal of Marketing*, 62, 89-100.
- Lantz, G. & Loeb, S. (1996). Country of origin and ethnocentrism: An analysis of canadian and American preferences using social identity theory. *Advances in Consumer Research*, 23, 374-378.
- Leibenstein, H. (1950). Bandwagon, snob, and Veblen effects in the theory of consumers' demand. *The Quarterly Journal of Economics*, 64(2), 183-207.
- Lopez, C. & Balabanis, G. (2021). The influence of a country's brands and industry on its image. *European Journal of Marketing*, 55(1), 27-62.
- Mangnale, V.S., Potluri, R. M. & Degufu, H. (2011). A study on ethnocentric tendencies of ethiopian customers. *Asian Journal of Business Management*, 3, 241-250.
- Miller, G. (2009). *Spent: Sex, Evolution, and Consumer Behavior*. New York: Viking.
- Nakip, M. & Gökmen, A. (2017). An empirical survey of consumer ethnocentrism in kazakhstan and the preference of consumers on imported products. *Bilig*, 82, 65-90.
- van Prooijen, J. W. & Krouwel, A. P. M. (2016). Extreme political beliefs predict dogmatic intolerance. *Social Psychological and Personality Science*, 8(3), 292-300.
- Rokeach, M. (1960). *The open and closed mind*. New York: Basic Books.
- Shankarmahesh, M. N. (2006). Consumer ethnocentrism: An integrative review of its antecedents and consequences. *International Marketing Review*, 23(2), 146-172.
- Shimp, T. A. and Sharma, S. (1987). Consumer Ethnocentrism: Construction and Validation of the CETSCALE. *Journal of Marketing Research*, 24(3), 280-289.
- Sumner, W. G. (1911). *Folkways*. Boston: Ginn & Company Publishers.
- Topçu, U.C. (2014). *Tüketicilerin Etnosentrik Tüketim Eğilimleri İle Sosyo-Politik Tutumları Arasındaki İlişkiler* [The Relationship between Consumers'



Ethnocentric Tendencies and Socio-Political Attitudes]. Unpublished master's thesis. Çanakkale Onsekiz Mart University Graduate School of Social Sciences, Çanakkale, Turkey.

- Wang, C.L. & Chen, Z.X. (2004). Consumer ethnocentrism and willingness to buy domestic products in a developing country setting: testing moderating effects. *Journal of Consumer Marketing*, 21(6), 391-400.



“

## Chapter 6

**THE EFFECT OF SOCIAL MEDIA  
MARKETING PRACTICES ON GREEN  
PURCHASING BEHAVIOR**

*Tuğba YEĞİN<sup>1</sup>*

”

---

<sup>1</sup> Dr. Tuğba Yeğın, Karabuk University , Turkey, yegin.tugba.dr@gmail.com, Orcid:<https://orcid.org/0000-0003-0623-4396>

## 1. Introduction

While global climate change shortens the life span of the universe, it endangers the future of nature, the environment, and living and non-living things. Research predicts that water and food shortages will be added to the energy scarcity that has increased in recent years, in the next 50 years(Chan & Lau, 2000; L. Chen et al., 2021; Han et al., 2022; Khalifeh Soltani et al., 2022; Kim & Ko, 2012; Molajou et al., 2021; Mostafa, 2007; Sun & Wang, 2019). While trying to find solutions that will eliminate all the causes that put the ecological cycle in the atmosphere into trouble, scientists, who call on humanity to change traditional consumption habits, draw attention to the necessity of a sustainable life(Chuah et al., 2020; Costa et al., 2021; Fiore et al., 2017; Joshi et al., 2021; Sellitto et al., 2020; Varah et al., 2021). At the global level, all countries and sectors that have a place in the world economy unite around a common goal and strive for their responsibilities within the scope of the sustainable development plan. Ecological threats do not require short-term solutions, but solutions that will improve the world in the long run and that will be fulfilled willingly, not an obligation that will continue for generations(Awan et al., 2021; Tseng et al., 2013; M. Wang et al., 2021; Yadav & Pathak, 2016b). For this, experts, scientists, politicians in countries, national and international panels, congresses, conferences, etc. They come together and try to persuade societies to sustainable and green consumption. Politicians and experts who make strategic plans within the framework of major goals such as preventing air and water pollution, minimizing environmental damage, ensuring the reuse of raw material resources, making the spent resources reusable, making consumption less costly, and cleaning the world from the elements that threaten the health of humanity(Li et al., 2021; Paul et al., 2016a; M. Wang et al., 2021; Yadav & Pathak, 2016b). In addition to bringing society to this awareness, it also assigns duties to the energy, agriculture, and service sectors that shape the economic graph(Chuah et al., 2020; Sellitto et al., 2020).

Since the fashion industry, whose export value is expected to reach \$1,032 by the end of 2022, is one of the most unsustainable industries in the world, the leading brands of the industry should exert more effort for sustainable change, act with more environmental awareness, and persuade all their loyal customers to purchase sustainable products(Sustainable fashion worldwide Report, 2022). The most useful places to reach customers for persuasion are now social media platforms(Digital Report, 2022). Social media platforms, which enable two-way communication and interaction on the internet to create a purchasing instinct in an individual, are places where brands can talk about environmental problems with their customers, so green product promotions to be made here can attract the

attention of customers. According to the (Digital Report, 2022), as of July 2022, there are 4.95 billion internet users (62.5% of the world's population) and 4.62 billion social media users (58.4% of the world's population). We see that almost every internet user is a social media user. Social media platforms can even change the politics of the world with comments made with just one tag in seconds(Digital Report, 2022).

Social media, which includes all of the important online platforms (Instagram, Facebook, Twitter, TikTok, etc.) that encourage consumers to buy green products, listen to their opinions on this issue, and facilitate one-to-one communication, can also help brands adopt sustainable products to society. Social media, which has reached 4.7 billion users as of July 2022, is a tool that brings instant impact to brands where all brands can promote green products, raise awareness about the environment, and green their brand image and brand equity(Digital Report, 2022; Sustainable fashion worldwide Report, 2022). For a sustainable future, it is beneficial to offer promotions, advertisements, informative and guiding content that encourages individuals to have the intention to purchase green products or to buy more green products over time, and also to determine the frequency of customers' entering the gender, income status, place of residence, pages of their customers. With its double-sided use, which is effective in obtaining personal data, the contribution of social media, one of the most important online marketplaces of today, to green product marketing in many respects has been revealed in a limited number of previous studies (only seven studies as of 2022 through Web of Science data search)(Amin & Tarun, 2021; Pop et al., 2020; Sun & Wang, 2019). In developing countries such as Turkey, which is in the infancy of green and sustainable consumption, more environmental awareness, sustainable consumption, adoption of green products, etc. We anticipate that more use of social media will have beneficial results as a means of delivering promotional activities to the public in an effective, efficient, instant, and faster way than other traditional methods. Therefore, in this study, we seek answers to the following two problems:

1. *Do Social Media Marketing practices (SMMP) have an impact on consumer's intention to buy green products?*
2. *Do Social Media Marketing practices (SMM) affect consumers' green product purchasing behavior?*

In this research, according to the Turkey textile industry analysis report (2021), which has become famous with its environmentalist approaches in the fashion industry, the Swedish-based H&M brand, whose turnover in Turkey is 1.6 billion TL as of 2021, is aimed at consumers over the age of 18 and the population of Turkey. Between 15 May 2022 - 10 July 2022, we

conducted an online survey with 286 participants in Ankara, which is the 5th capital in the world in terms of air pollution, and Karabük, which has a low population density and is dominated by the iron and steel industry and ranks 6th in air pollution in Turkey. We performed a two-stage SEM analysis with the obtained data. In the first stage, we performed EFA, CFA, and reliability analysis for each questionnaire, since our questionnaire was obtained by combining three different scales.  $AVE > .50$ ,  $CR > .60$ , Cronbach's Alpha values  $> .70$  of the scales were obtained above the threshold values in the literature. In the second stage, we tested the hypotheses that we put forward by the model of the study with path analysis. SEM findings revealed that SMMP will be effective in consumers' adoption of green products and their purchasing behavior. It was also found that consumers' adoption of green products is effective in their green product purchasing behavior. Some studies in the literature have said that behavioral intentions may not always translate into actual behaviors (Ahmed et al., 2021; Ajzen, 1991; Yadav & Pathak, 2017a; Zahan et al., 2020). Therefore, we have made the literature gap more superficial by expanding the very limited field of study on the relationship between SMMP and GPI and GPB, as well as responding to the calls of studies recommending that behavioral intention studies look at the relationships between GPI and GPB (Hulland & Houston, 2021; Sniehotta et al., 2005; Vermeir & Verbeke, 2006; Webb & Sheeran, 2006). With the results of this study, we have made practical contributions by explaining the necessity of SMMP applications to the managers and marketers of environmental fashion brands that want to increase their sales of green and environmentally friendly products. As far as the author knows, this research has unique value as it is the first study in the fashion industry to demonstrate that SMMP is a front component and direct influencer marketing strategy in consumers' adoption of green products and green product purchasing behavior, including the Web of Science. The sustainable development plan, which is followed carefully with the increase of environmental problems, the society's orientation towards sustainable consumption, the brands' awareness of consumers through social media, and the production of green and sustainable products, but not yet reached the desired amounts in green product sales, especially fashion that seeks ways to increase green product sales (Sustainable fashion worldwide Report, 2022). We offer practical information based on quantitative analysis to the brands of the sector for their improvement. In addition, with the findings of this study on social media marketing practices to increase green product purchasing behavior, e-commerce, digital shopping, green product, sustainable consumption, social media marketing, content marketing, etc. we are paving the way for a wide range of literature that can be done in many fields. We hope that this research will shed light on future studies to adopt more green products in the context of SMMP.

This study continues as follows: Part 2: Theoretical framework and research hypotheses; Chapter 3: Methodology; Chapter 4: Results; Chapter 5: Discussions; Chapter 6: Conclusions

## **2. Literature Review**

### **2.1. Green (Sustainable) Fashion Products**

Green products stand out, especially with their environmental aspects (Teixeira et al., 2012). Sustainability of products such as food, clothing, and packaging, which provide outputs as harmful substances to the environment after consumption, means that the product is produced as reusable, replaceable, developable after years, durable, with low resource expenditure and without CO<sub>2</sub> emission (Kumar & Mohan, 2021; Salem & Alanadoly, 2021; Teixeira et al., 2012; Tu et al., 2020). The fact that cotton, flax, and hemp are the most used raw materials in the textile industry nowadays supports sustainable production by not processing them in artificial intelligence machines. For example, famous international brands such as Mother of Pearl, Maggie Marilyn, Stella McCartney, Tommy Hilfiger, Nike, H&M, Zara, and Adidas offer their green products to the market in various varieties. Research conducted at the global level revealed that 75% of the society has a positive view of sustainable textile products, while the Y generation is the most interested (Kumar & Mohan, 2021). That's why famous clothing brands are looking for ways to deliver their products to more customers and compete while greening their production strategies and raw materials for sustainability (Bernardi et al., 2022; Moser, 2016). For this reason, fashion brands are actively using these social media channels, as they are in all sectors, due to the widespread use of social media channels these days and the convenience of reaching customers and establishing bilateral and interactive communication (Castillo-Abdul et al., 2021; Nash, 2019). Through social media, they create promotional and awareness content that reveals their environmentalist aspects to their customers, and they can also draw the attention of the customer mass who accept sustainable products to their brands by highlighting the environmentalism of their green products (Bernardi et al., 2022; Castillo-Abdul et al., 2021; Moser, 2016; Nash, 2019; Salem & Alanadoly, 2021). However, all these marketing efforts for green products on social media need to investigate further how effective consumers are in adopting green fashion products and how they can increase this effect (Bernardi et al., 2022). In this context, this study aims to expand the adoption of green products in the context of SMMP, answering the calls of some research (Bernardi et al., 2022; Brandão & Costa, 2021; Kim & Ko, 2012; Loureiro et al., 2019; Nash, 2019; Salem & Alanadoly, 2021; Sustainable fashion

worldwide Report, 2022) that suggests that more theoretical and practical research is needed.

## 2.2. Social Media

Social media, which has been an extremely important discovery for marketing, management, and the business world in recent years, is a mutual communication channel established based on Web 2.0, Web 3.0, and Web 4.0 in the most general sense. They are social environments where technological developments that include interaction that allow the development and sharing of the content created by organizations or individuals are applied within seconds (Filo et al., 2015; Mason et al., 2021). Social media, where people create profiles that they can edit, share their feelings (individual opinions, thoughts, expectations, etc.), and follow other members of the same platform, are the channels that users choose to socialize (Filo et al., 2015; Gartner et al., 2021; Kim & Ko, 2012; Mason et al., 2021; Pop et al., 2020; Sun & Wang, 2019)

Although social media offers an environment where content is shared, Web 2.0 is a platform that expresses all the ways of producing content and using social media, and it is a platform where this content is developed by cooperating in the environment, knowingly or unknowingly (Peeters, 2018)

Brand owners trying to attract the attention of consumers use their data and integrate social media platforms into their advertising campaigns (Loureiro et al., 2019). Most of the brands that did not go through this change began to be forgotten in their minds (Dhawan, 2020). Social media marketing, which includes many fields from the construction industry to furniture, from the fashion industry to white goods, from the cosmetics industry to automotive, is one of the newest marketing strategies. The source of sustainable strategies in this direction is the internet and social media advertising. The replacement of 4P methods with 4C methods has led to a series of changes in the consumer value, pricing, distribution, and promotion methods of brands (Huang, 2022). Reaching the consumer is no longer about making them come to the stores, but by coming to the digital stores and examining their active movements.

Everything that consumers talk about, look for on the internet, talk about brands, and everything they think about, appears in front of them in the digital environment within seconds (Nanda et al., 2021).

Facebook, Whatsapp, Instagram, LinkedIn, Twitter, etc. platforms offer mutual information to both consumers and businesses (Fraccastoro et al., 2021; Senthil Raja & Arun Raj, 2021). For example; Profiles similar to a profile that an individual looks at on Instagram are constantly sponsored by the consumer (Fraccastoro et al., 2021; Kim & Ko, 2012; Mason et al.,



2021; Senthil Raja & Arun Raj, 2021; Sun & Wang, 2019). When creating sponsored promotional advertisements, businesses stand in front of social media users by choosing the location, interest, gender, and age range they want to address. After they manage to attract their attention, they offer their products or services with instant discounts and personalized applications (Kim & Ko, 2012; Mason et al., 2021; Sun & Wang, 2019). Social media has already taken its place in marketing strategies (Guan et al., 2022).

### **2.3. Social Media Marketing**

Global technological change not only connects people but also creates new markets for businesses. With the increase in the use of social media, the marketing practices of the enterprises, the places of promotion of their products or services, promotion, pricing, distribution methods, business-customer relations, and customer attitudes are changing (Kartajaya et al., 2016; Kotler, 2017, 2018)

Marketing is a process that includes businesses determining the wants and needs of consumers, offering their products or services to the market to meet these wants and needs, promoting, making sales, and after-sales support services. This process is always open to innovation and technology.

Social networks are one of the ways that add a different dimension to the realization of marketing applications. Social media marketing makes it easy to move the 4P (Product, Price, Place, Promotion) process to the 4C (Customer Value, Customer Cost, Customer Convenience, Customer Communication) process; businesses to promote, advertise, sell their products or services, increase brand awareness, gain brand loyalty, etc (Dash et al., 2021; Jiménez-Zarco et al., 2019; Wereda & Woźniak, 2019). It is one of the newest marketing strategies that include active applications. In other words, it is all marketing strategies made through social media platforms.

Social media marketing can be given in three stages (Cao et al., 2021):

- Finding a good idea
- Reaching the right target
- Allocate the right budget

Marketers identify and deliver potential buyers according to the interests, likes, and locations of the customer group through social networking platforms (YouTube, LinkedIn, Facebook, Twitter, Instagram, dictionary sites, blogs, etc.) where mutual communication is dominant. While performing all these steps, they should set their budgets well (Bilro

et al., 2022; Cao et al., 2021). It should be able to profit from both time and cost, and it should realize effective, efficient, and profitable sales with the right budget. Social media marketing allows brands to (Sedalo et al., 2022):

- They can offer their products or services.
- They can benefit from customers' knowledge.
- They can get customers to help customers.
- They can stay in contact with their internal (employees, etc.) and external environment (state, foundation, a private institution, competitor, etc.).

Social media marketing is helpful to other marketing strategies that the brand maintains. Social networks offer new online methods for the implementation of traditional marketing practices and enable mutual communication with customers. Social media plays a role in providing the opportunity for the marketing strategies of the business to establish individual relations with customers and to reach them individually (Hysa et al., 2021; Kim & Ko, 2012; Sedalo et al., 2022; Sun & Wang, 2019) While social media has made customers more special in the eyes of businesses, it has made the products and services of brands more accessible in the eyes of customers in terms of searching, evaluating, choosing, purchasing and promoting them to their environment (Hysa et al., 2021; Kim & Ko, 2012). Brands can use social media and their data to achieve their marketing goals (Philp et al., 2022)

- **Idea Mining:** Businesses use the information obtained from the data collected through social media for their benefit by revealing insights and patterns. (Saura et al., 2022) Using idea mining, businesses extract usable and applicable models to “achieve strategic business goals” and “provide a competitive advantage in the market” (Saura et al., 2022; Youn & Jung, 2021)

- **Targeted Advertising:** It contributes to the personalization of social media marketing. Collecting data about their customers provides a great mutual communication to develop personalized solutions and applications for their customers (Crimley & Gillespie, 2019; Ruckenstein & Granroth, 2020)

- **Customer Relations:** One of the focal points of a business's marketing strategies is to manage customer relations well (Anshari et al., 2019) Social media is one of the ways to create close bonds with customers. It is possible to attract customers, interact with each other, and reach the environment of customers with social media (Fraccastoro et al., 2021;

Gartner et al., 2021; Loureiro et al., 2019; Pop et al., 2020). Being in the right place at the right time and delivering the right products to the right consumers is much easier with the information generated from social media data (Anshari et al., 2019). Including social media in traditional customer relationship management strengthens the hand of marketing (Bilro et al., 2022; Fraccastoro et al., 2021)

## **2.4. Social Media Marketing Practice**

Social media, which makes communication one-way mutual, directly connects businesses with their customers. Social media is characterized as interactive and participatory. The traditional ways of communication that businesses choose to describe their green products or services are one-way. Traditional communication channels make consumers only buyers. Social media communication has changed this system, making consumers not only buyers of content but also active creators of brand information and brand image, which are components of brand value (Seo et al., 2020a). With social media, brand owners have lost control over the content of their messages about their brands. Although this situation presents challenges and opportunities for brand owners, there is a reality that must be accepted; power has shifted from brands to consumers (Seo et al., 2020a; Swaminathan et al., 2020)

The field of social media, which has long been one of the preferred means of communication for businesses that want their customers to know about their green products or services in real and virtual markets, is constantly evolving (Orben, 2020; Prestridge, 2019; Swaminathan et al., 2020). The rapid change and development of technology and the internet necessitated the inclusion of information systems in marketing strategies. Social media is considered very advantageous for businesses that are open to technological developments and take care to keep communication with their customers sustainable within their management strategies (Anshari et al., 2019; Seo et al., 2020b). Participants who are members of social networking sites can share their profile with their interests, needs, wishes, opinions or thoughts, etc. form accordingly. Users can find and add users with similar interests to their networks by searching the network or inviting others to join (Bilro et al., 2022; Jacobson et al., 2020). In the same way, businesses want to address the customer groups of social media features such as age, country, city, education, gender, interests, etc. can be accessed by filtering them according to personal information.

Traditional media tools (TV, newspaper, radio, magazine, etc.) that offer visual, audio, or printed content to the consumer are some small and some very large organizations that distribute expensive content (Filo et al., 2015; Martens et al., 2018). Businesses must pay these organizations to

deliver their ad content to their customers (Haenlein et al., 2020; Morkunas et al., 2019). Adjusting the frequency, duration, and target audience of the content depends on the effective work of the advertising agency where the brand works (Childers et al., 2019). They serve their ad content to the general audience and it is difficult for them to observe the return rate (Childers et al., 2019). However, social media ads are directly owned by the brand. Brands can deliver their promotional activities about their green products to the customer base they want, whenever they want, with the budget they want. It can communicate closely with its customers, send gifts on special occasions, and organize campaigns for limited times. In other words, social media marketing not only saves time and cost for the brand, but also promotes the company's green products, makes its customers aware of green products, and can green the brand image in society regarding its environmental development and responsibility for the environment.

Past research has revealed that social media platforms affect individuals' purchasing behavior, decision-making processes, and attitudes towards green products (Pop et al., 2020; Sun & Wang, 2019). To increase the purchase of green products, businesses should be on more than one social media platform and announce their environmentalist aspects to their customers with SMMP. In this context, with the improvement of SMMP, we design the assumptions that we will test with the empirical application of this research in the next title, based on theoretical past research, to facilitate more adoption and real purchase of green products by consumers, and to facilitate the progress of marketers and brand managers in their marketing strategies for green products.

## **2.5. Design of Hypotheses**

In this study, we evaluate purchase intention, which means the probability of realizing a green product purchasing behavior, for green products. Green purchase intention is the instinct of consumers to purchase green products with the awareness of environmental protection and includes consumers' environmental concerns about not only the quality of a product but also the consequences of their purchasing decisions (Dagher & Itani, 2014). In other words, consumers are concerned not only with the ecological quality of the product but also with the environmental consequences associated with their decision to purchase such products (Costa et al., 2021).

Green purchasing behavior, on the other hand, refers to the purchase of environmentally friendly and sustainable products produced with recyclable raw materials, which enable consumption with less waste material, and avoids consumption that harms the future (Dagher & Itani, 2014; Guerreiro & Pacheco, 2021; Jaiswal & Kant, 2018a; Sharma et al., 2020).

Most of the studies examining the consumption of green products have revealed that individuals show a sense of environmental concern and intention to purchase green products (Dagher & Itani, 2014; Guerreiro & Pacheco, 2021; Jaiswal & Kant, 2018b, 2018a; Moser, 2015; Sharma et al., 2020) As a way for brands to increase sales of green products, it is recommended that consumers engage in activities to increase environmental awareness. For example; (Săplăcan & Márton, 2019) focused on reducing waste on brands' social media pages, using recyclable materials, etc. They showed that the information they gave about their applications increased the environmental concerns of consumers. Also, (Z. Wang et al., 2012) stated that social media content makes consumers' purchasing preferences similar to their peers and makes them want to buy more. Brands' social media page content can affect consumers' trust and loyalty to the brand (Ibrahim et al., 2021; Ibrahim & Aljarah, 2021; Lin & Kim, 2016). Consumers' trust in green products is affected by their social media sharing (Czarnecka et al., 2022). It can be said that consumers use social media an influencing green product purchase intentions and behaviors (Pop et al., 2020; Wijekoon & Sabri, 2021). In addition, (Murwaningtyas et al., 2020) showed that the content shared by brands on their social media pages for organic products positively affects consumers' organic product purchase intentions and behaviors(Pop et al., 2020).

In this study, we argue that brands can bring more environmental awareness to individuals through their social media pages and that social media marketing practices that increase environmental awareness can positively affect consumers' green product purchase intentions and green product purchasing behaviors. In this context, we make the following assumptions:

*H<sub>1</sub>: Social media marketing practices have a positive and positive effect on consumers' green purchase intention.*

*H<sub>2</sub>: Social media marketing practices have a positive and positive effect on consumers' green purchasing behavior.*

There is evidence that there is a direct relationship between the intention to purchase green products and the actual purchasing behavior of these products. The willingness to buy green products, which is caused by environmental concerns, can turn into real behavior over time (Joshi et al., 2021; Murwaningtyas et al., 2020; Paul et al., 2016b; Saari et al., 2021; Yadav & Pathak, 2016a, 2017a) However, there are findings in the literature that contradict this result (Vermeir & Verbeke, 2006; Webb & Sheeran, 2006). Behavioral intentions sometimes fail to translate into actual behaviors (Adel et al., 2022; Hulland & Houston, 2021; Saari et al., 2021) Based on other studies on the intention to purchase environmentally

beneficial products, which has been revealed as a factor leading to green product purchasing behavior, we make the following assumption:

*H<sub>3</sub>: Consumers' green purchasing intentions have a positive and positive effect on their green purchasing behavior.*

We present the following model to analyze the accuracy of our assumptions based on theoretical proofs with SEM (Fig. 1).

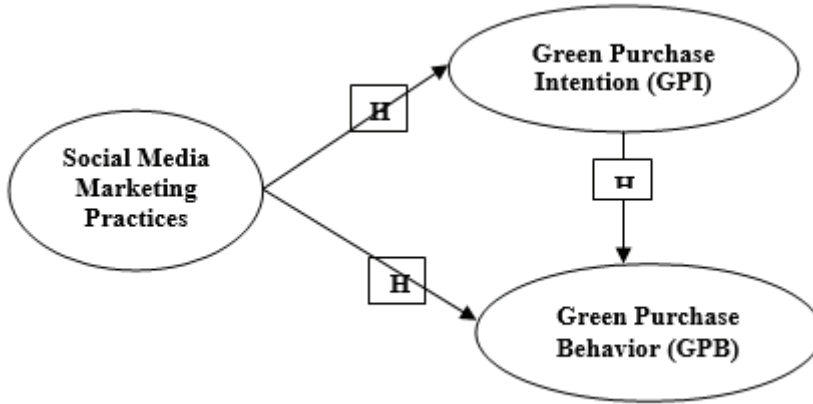

**Figure 1.** *Model of empirical research*

**Source:** The Authors

We use the model we created to investigate the relationship between social media marketing practices and consumers' green purchasing intention and behavior for the SEM analysis of the research in the next sections (Fig. 1).

### 3. Methodology

#### 3.1. Measures

For this research, we prepared a questionnaire consisting of two parts. The first part of the survey consists of items asking whether the participants follow the social media pages of a famous fashion brand, H&M, and if so, which platforms they follow, and then their demographic information.

The second part; consists of a combination of three different scales that we want participants to rate all variables with a five-point Likert scale: For the scale of the social media marketing practices of the H&M brand (11 items), (Kim & Ko, 2012); For the Green Purchase Intention (GPI) scale (3 items), (Yadav & Pathak, 2017b); For the Green Purchase Behavior (GPB) scale (5 items), (Amit Kumar, 2021). (Appendix A)

## 3.2. Sample and Data Collection

In this research, according to the Turkey textile industry analysis report (2021), which has become famous with its environmentalist approaches in the clothing industry, the Swedish-based H&M brand, which has a turnover of 1.6 billion TL as of 2021, in Turkey with its consumers over the age of 18 and Turkey's population. We conducted an online survey from 15 May 2022- 10 July 2022 in Ankara, which is the 5th capital in air pollution in the world, and Karabük, which is the 6th in air pollution in Turkey, dominated by the iron and steel industry, with a low population density.

In cases where it is not possible to reach the whole population, we performed sampling with the random method recommended in the literature in the field of statistics (Tabachnick et al., 2007). We determined our sample based on the threshold value criterion (number of scale items 10), which is considered sufficient in the literature for structural equation modeling (SEM) (Anderson & Gerbing, 1988; Hair et al., 2010). In this context, we got help from a statistics company that has the data of H&M consumers. In the company's database, the number of customers of the H&M brand over the age of 18 and residing in the provinces of Ankara and Karabük was 1547. But there were only 854 consumers with contact information. However, 349 consumers participated in the surveys. We excluded 58 questionnaires, which we discovered incompatible with the manual review. We performed a two-stage SEM analysis with data from the remaining 286 participants (Anderson & Gerbing, 1988). Table 1, describes the data collected with the survey.

*Table 1. Survey information.*

<b>Study parameters</b>	<b>Value</b>
Time	15 May 2022- 10 July 2022
Location	Ankara and Karabük, Turkey
Sample size	347
Valid responses	286
Response rate	%84,14

## 4. Results

### 4.1. Sample Characteristics

The demographic profile, of which the majority of the female participants (82.9%) were, are given in Table 2. The participants were married (63.6%), predominantly millennials (79.7%), academic researchers (33.1%), and had monthly incomes in the range of -100\$ (23.7%). The majority of the participants are influenced by Instagram

and influencer ads, 42% of them spend time on social media between 2-5 per day. And the majority of our respondents (46,7%) said they were impressed by Instagram Business Promotion Ads.

*Table 2. Demographic Results*

Demographic	Group	%	Demographic	Group	%
gender	Male	17,1	The Time Spend Daily on Social Media	Less than 1 Hour	7,3
	Woman	82,9		1-2 Hours	29,7
marital status	single	36,4	Influence Social Media Ads	2-5 Hours	42,0
	married	63,6		5-10 Hours	15,0
generation	1965-1980 (X)	18,2	household income level	10-15 Hours	4,2
	1980-1999 (Y)	79,7		More than 15 Hours	1,7
	2000-2020 (Z)	2,1		Experts in the field	3,2
job	Not working/Retired/Student	7,6	Influence Social Media Ads	Draw	,4
	officer	9,1		Facebook Ads	4,9
	Private sector	20,5		real user reviews	,4
	Executive	,7		Google Ads	8,1
	Owner of Your Own Business	4,9		none	1,9
	Lawyer	,7		Discount	,4
	Military personal	1,0		Ads that serve my needs and purposes	,4
	Police	,7		Advertisement of my interests	,4
	Health Sector Personnel	3,1		Influencer Promotions	33,0
	Academician	33,1		Instagram Business Promotion Ads	46,7
	Engineer	3,5		I don't like ads	,8
	Financial Advisor	,7		-100\$	24,8
	Other	6,3		100\$-300\$	15,8
				301\$-400\$	23,7
		401\$-500\$	19,9		
		501\$-600\$	12,3		
		601\$+	3,5		

## 4.2. Reliability and Validity Analysis Results

The adequacy of the sample size for scales (which is SMMP (KMO=0.897 >0.500; Bartlett X<sup>2</sup> value=1558.311, p<0.05), GPI (KMO=0.736



>0.500; Bartlett  $X^2=482.455$ ;  $p<0.05$ ), and GPB (KMO>0.500; Bartlett  $X^2=759,400$ ;  $p<0.05$ )) was sufficient for factor analysis as it provided the necessary threshold values in the literature. Thus, in the first stage, we first performed the scales' reliability, convergent and convergent validity, factor loading, explained variance and Pearson correlation, Cronbach's alpha for multicollinearity problems, exploratory factor analysis (EFA), and confirmatory factor analysis. According to the EFA results, the SMMP scale consisted of 11 items for a single factor (factor loadings ranged from 0.448 to 0.846, the total variance explanation rate was 48.860), and the GPI scale was for a single factor with 3 items (factor loadings ranged from 0.880 to 0.920, the rate of explaining the total variance was 81.441). ), GPB scale with 4 items and a single factor (3rd item was not included in the analysis because the factor load was less than 0.300. Factor loadings ranged from 0.854 to 0.912, and the total variance explanation rate was 77.438). We obtained the Cronbach's alpha (>.70); average variance explained (AVE>.50), composite reliability (CR>.60), and values for the three scales (Table 3)(Bagozzi, 1992; Fornell & Larcker, 1981; Hair et al., 2010). It is seen that all fit indices calculated in the CFA analysis provide acceptable fit indices (table 4). Pearson correlation analysis results (SMMP\_GPI=0.765; SMM\_GPB=0,741; GPI\_GPB=0.845) showed that strong positive relationships could be established between these factors (Table 5). VIF(<5) was below the threshold value and no multicollinearity problem was observed regarding the scale (Table 6)(Hair et al., 2010, 2011).

**Table 3.** Factor loading, AVE, CR, Cronbach's Alpha Results for SMM, GPI, and GPB

Scale	Items	Factor Loading	Explained rate of variance	AVE	CR	Cronbach's Alpha
	SMM8	.846				
	SMM11	.805				
	SMM9	.795				
	SMM1	.790				
	SMM7	.785				
SMM	SMM5	.709	48.860	0.44	0.89	.889
	SMM2	.658				
	SMM4	.637				
	SMM10	.550				
	SMM6	.541				
	SMM3	.448				

GPI	GPI2	.920	81.441	0.73	0.89	0.886
	GPI3	.907				
	GPI1	.880				
GPB	GPB4	.912	77.438	0.73	0.89	0.886
	GPB5	.884				
	GPB1	.869				
SMM	GPB2	.854		0.69	0.90	0.902

**Table 4.** The goodness of Fit Values Results for SMM, GPI, GPB scales

Acceptable Fit Indices	SMMP	GPI	GPB
$\chi^2/sd \leq 5$	3,568	0,614	2,685
GFI > 0.90	0,916	0,999	0,995
AGFI > 0.85	0,864	0,991	0,998
NFI > 0.90	0,908	0,999	0,953
CFI > 0.90	0,931	1,000	0,998
RMSEA < 0.10	0,095	0,000	0,077

**Figure 2.** Path results for Measures

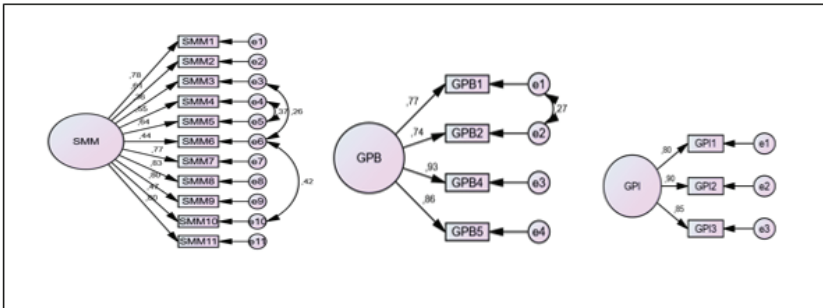

**Table 5.** Pearson Correlation Results

Factor	SMMP	GPI	GPB
SMMP	1	.765**	.741**
GPI		1	.845**
GPB			1

\*\*p<0,01

**Table 6.** *VIF and Tolerance Values*

Relationship	VIF	Tolerance
GPB<---SMM	1,000	1,000
GPI<---SMM	1,000	1,000
GPB<---GPI	1,000	1,000

### 4.3. Results for Hypotheses

The path map of the CFA analysis for the model is given in Figure 3. Model fit indices in CFA analysis provided the threshold values in the literature.

**Table 7.** *Inter-order relations values.*

X <sup>2</sup> /df	p	RMSEA	CFI	GFI	AGFI	NNFI	NFI	RMR	SRMR
1,740	0,000	0,037	0,99	0,93	0,85	0,99	0,99	0,025	0,016

We used the SEM analysis, which is frequently used in testing the effect hypotheses in green product purchase intentions and green product purchase behavior studies and gives reliable results, to test our assumptions based on the model of this research. SEM results revealed a standardized  $\beta$  (path coefficient) of 0.92,  $p < .001$  (SMMP  $\rightarrow$  GPI), standardized  $\beta$  of 0.88,  $p < .001$  (SMMP  $\rightarrow$  GPB) (Figure 3, Table 8). Thus, “H<sub>1</sub>: Social media marketing practices have a positive and positive effect on consumers’ green purchase intention.” and “H<sub>2</sub>: Social media marketing practices have a positive and positive effect on consumers’ green purchasing behavior.” are accepted.

In addition, as a result of the path analysis for the direct relationship between GPI and GPB, the standardized  $\beta$  value was 0.94;  $p < .001$  was obtained (Figure 3, Table 8). This result indicates that “H<sub>3</sub>: Consumers’ green purchasing intentions have a positive and positive effect on their green purchasing behavior.” confirmed his hypothesis.

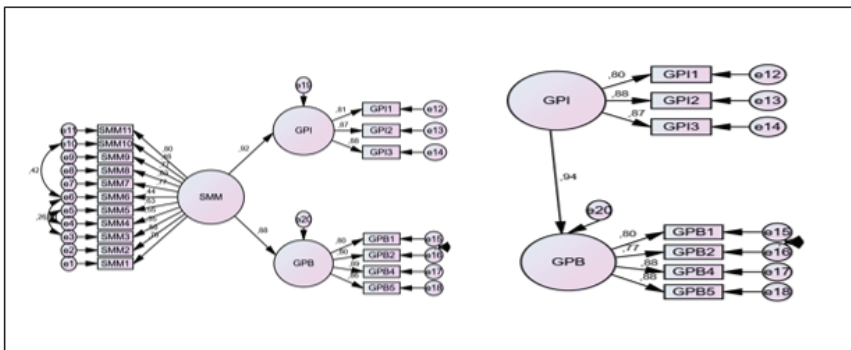

**Figure 3.** *Path Results for the Research Model*

**Table 8.** *SEM Results*

<b>Hypotheses</b>	<b>Roads</b>	<b><math>\beta</math> (path coefficient)</b>	<b>S.E.</b>	<b>C.R.</b>	<b>P</b>	<b>Conclusion</b>
H <sub>1</sub>	SMMP → GPI	0.92	,069	12,699	***	Accept
H <sub>2</sub>	SMMP → GPI	0.88	,067	15,382	***	Accept
H <sub>3</sub>	SMMP → GPI	0.94	,051	16,597	***	Accept

## 5. Discussion

This study investigated the effectiveness of social media marketing practices in the adoption and purchase of green products in the fashion industry. In this context, the results of EFA and CFA, which constitute the first stage of the two-stage SEM analysis, demonstrated the applicability of the scale adapted from the literature suitable for the model of this study for the sample and model of this study, as the reliability and validity values provided the threshold values specified in the literature (Fornell & Larcker, 1981; Hair et al., 1998, 2010). The results of the path analysis, which tested the assumptions of this study, which was carried out in the second stage of the SEM analysis, confirmed the H<sub>1</sub>, H<sub>2</sub>, and H<sub>3</sub> hypotheses.

According to the SEM result for the first and second hypotheses, “H<sub>1</sub>: Social media marketing practices have a positive and positive effect on consumers’ green purchasing intention.” and “H<sub>2</sub>: Social media marketing practices have a positive and positive effect on consumers’ green purchasing behavior.” accepted. In other words, when there is a one-unit positive increase in the consumer response to social media marketing practices, 0.92 units of consumers’ intention to buy green products and 0.88 units of green products’ purchasing behavior will be seen, with 95% significant SEM results for both hypotheses (F. Hair Jr et al., 2014; Hair et al., 2011). Thus, it has been obtained in previous studies that consumers’ attitudes towards green products and environmental pressure are effective on their intention to purchase green products and their purchasing behavior (Amit Kumar, 2021; S.-C. Chen & Hung, 2016; Chuah et al., 2020; ElHaffar et al., 2020; Hsu et al., 2017; Paul et al., 2016a; Varah et al., 2021; Yadav & Pathak, 2016b). We obtained a similar result for the fashion industry with the results of the study (Pop et al., 2020), which focused on the effect of social media on consumer’s intention to purchase green cosmetics. The foundation of SMMP is based on the communication of individuals with each other and with brands. The fact that this new marketing strategy is preferred by almost all national and international brands is that it facilitates reaching consumers and mutual communication. In this context, in addition to other research built on the green product market, we gain with our empirical application findings that it is possible for brands to improve their SMMP based on environmental awareness and to make their green products more

accepted, and we pave the way for future research on narrowing the gap in the literature on this effect.

According to the SEM result regarding the third hypothesis of the research, “H3: Green purchasing intentions of consumers have a positive and positive effect on their green purchasing behavior.” Accepted. Thus, if consumers accept one unit of green products, it may become 0.94 percent more likely that these consumers to buy green products. Many studies from different fields in behavioral intention studies sometimes overlooked this effect (Paul et al., 2016a; Rausch & Kopplin, 2021; Yadav & Pathak, 2017a; Zahan et al., 2020). However, the intention of individuals against a behavior may not turn into real behavior in some cases. Empirical research demonstrating this result has been done in the past (Blom et al., 2017; Hsu et al., 2017; Liu & Ye, 2016; Moon, 2021; Rausch & Kopplin, 2021). The main purpose of the millions of investments built to prevent ecological problems is to buy green and sustainable products by consumers instead of traditional products. The conclusion of this hypothesis of the study presents to the literature and practical practitioners that the adoption of green products in the context of SMMP is effective in transforming real purchasing behavior. Thus, a valuable contribution is made to the limitations in the literature.

## 6. Conclusions

In this study, we make inferences that will add value to the literature on the relationship between social media marketing and green purchasing behavior. To understand the role of social media in consumers' attitudes towards purchasing green products, an empirical case study is conducted and assumptions are tested and a model is proposed. Many previous studies have been conducted to examine the reasons for green buying behavior and adoption. These studies were mostly carried out with planned behavior theory and its expanded version and similar theories (Yadav & Pathak, 2016). With the new model we presented in this study, we go out of the ordinary and support our model with SEM analysis.

There is no limit to further research on more green and sustainable production and consumption, green marketing, and green purchasing behavior to prevent global environmental problems from continuing to increase. Each quality content contribution to the literature in an unlimited sense is very important. In this context, we provide a model for the use of social media for marketing, which has a high potential to affect green product purchase intention and behavior. Understanding consumer intent is a statistical way of minimizing uncertainty about the likelihood of that consumer performing a behavior. The results we have revealed with statistical values show not only the effects of social media marketing

practices on consumers' intention and behavior to purchase green products but also the response of any brand that produces green products to the social media marketing practices of the consumer. Therefore, with this study, we present the aspects that will benefit all brands that want to improve themselves on the path of green production, by using social media more effectively.

As a result, with the empirical findings of this research, we have found that SMMP, which is one of the innovations brought by technology quickly, which will be made by brands to promote and sell their green products in social media markets, is effective in individuals' adoption of green products and their purchasing behavior. The research has original value as it is the first study that provides more than one theoretical and practical contribution to the literature by analyzing the impact of SMMP on the adoption and purchasing of green products in the clothing industry and for consumers in Turkey in the context of developing countries. Since this study is the first to examine the relationship between social media marketing practices and consumers' green product purchase intentions and behaviors in a case study in Turkey, it serves as an example for future studies on social media marketing and green product purchasing.

Despite the valuable contributions of this study, there are also limitations. The first of these is the limited geography and population. For this reason, the continuation of this research can be done by selecting a sample addressing different geographies and population numbers. The second limitation is that this study has a timing of sustainable clothing that is new to the global level and has a low level of acceptance. Therefore, this research needs to be repeated and developed at different time intervals.

## REFERENCE

- Adel, A. M., Dai, X., & Roshdy, R. S. (2022). Investigating consumers' behavioral intentions toward suboptimal produce: an extended theory of planned behavior – a cross-cultural study. *British Food Journal*, *124*(1), 99–139. <https://doi.org/10.1108/BFJ-03-2021-0211>
- Ahmed, N., Li, C., Khan, A., Qalati, S. A., Naz, S., & Rana, F. (2021). Purchase intention toward organic food among young consumers using theory of planned behavior: role of environmental concerns and environmental awareness. *Journal of Environmental Planning and Management*, *64*(5), 796–822. <https://doi.org/10.1080/09640568.2020.1785404>
- Ajzen, I. (1991). The theory of planned behavior. *Organizational Behavior and Human Decision Processes*, *50*(2), 179–211. [https://doi.org/10.1016/0749-5978\(91\)90020-T](https://doi.org/10.1016/0749-5978(91)90020-T)
- Amin, S., & Tarun, M. T. (2021). Effect of consumption values on customers' green purchase intention: a mediating role of green trust. *Social Responsibility Journal*, *17*(8), 1320–1336. <https://doi.org/10.1108/SRJ-05-2020-0191>
- Amit Kumar, G. (2021). Framing a model for green buying behavior of Indian consumers: From the lenses of the theory of planned behavior. *Journal of Cleaner Production*, *295*, 126487. <https://doi.org/10.1016/j.jclepro.2021.126487>
- Anderson, J. C., & Gerbing, D. W. (1988). Structural equation modeling in practice: A review and recommended two-step approach. *Psychological Bulletin*, *103*(3), 411.
- Anshari, M., Almunawar, M. N., Lim, S. A., & Al-Mudimigh, A. (2019). Customer relationship management and big data enabled: Personalization & customization of services. *Applied Computing and Informatics*, *15*(2), 94–101. <https://doi.org/10.1016/j.aci.2018.05.004>
- Awan, U., Nauman, S., & Sroufe, R. (2021). Exploring the effect of buyer engagement on green product innovation: Empirical evidence from manufacturers. *Business Strategy and the Environment*, *30*(1), 463–477. <https://doi.org/10.1002/bse.2631>
- Bagozzi, R. P. (1992). The Self-Regulation of Attitudes, Intentions, and Behavior. *Social Psychology Quarterly*, *55*(2), 178. <https://doi.org/10.2307/2786945>
- Bernardi, A., Cantù, C. L., & Cedrola, E. (2022). Key success factors to be sustainable and innovative in the textile and fashion industry: Evidence from two Italian luxury brands. *Journal of Global Fashion Marketing*, *13*(2), 116–133. <https://doi.org/10.1080/20932685.2021.2011766>
- Bilro, R. G., Loureiro, S. M. C., & dos Santos, J. F. (2022). Masstige strategies on social media: The influence on sentiments and attitude toward the brand. *International Journal of Consumer Studies*, *46*(4), 1113–1126. <https://doi.org/10.1111/ijcs.12747>

- Blom, A., Lange, F., & Hess, R. L. (2017). Omnichannel-based promotions' effects on purchase behavior and brand image. *Journal of Retailing and Consumer Services*, 39, 286–295. <https://doi.org/10.1016/j.jretconser.2017.08.008>
- Brandão, A., & Costa, A. G. da. (2021). Extending the theory of planned behaviour to understand the effects of barriers towards sustainable fashion consumption. *European Business Review*, 33(5), 742–774. <https://doi.org/10.1108/EBR-11-2020-0306>
- Cao, D., Meadows, M., Wong, D., & Xia, S. (2021). Understanding consumers' social media engagement behaviour: An examination of the moderation effect of social media context. *Journal of Business Research*, 122, 835–846. <https://doi.org/10.1016/j.jbusres.2020.06.025>
- Castillo-Abdul, B., Bonilla-del-Río, M., & Núñez-Barriopedro, E. (2021). Influence and Relationship between Branded Content and the Social Media Consumer Interactions of the Luxury Fashion Brand Manolo Blahnik. *Publications*, 9(1), 10. <https://doi.org/10.3390/publications9010010>
- Chan, R. Y. K., & Lau, L. B. Y. (2000). Antecedents of green purchases: a survey in China. *Journal of Consumer Marketing*, 17(4), 338–357. <https://doi.org/10.1108/07363760010335358>
- Chen, L., Chang, J., Wang, Y., Guo, A., Liu, Y., Wang, Q., Zhu, Y., Zhang, Y., & Xie, Z. (2021). Disclosing the future food security risk of China based on crop production and water scarcity under diverse socioeconomic and climate scenarios. *Science of The Total Environment*, 790, 148110. <https://doi.org/10.1016/j.scitotenv.2021.148110>
- Chen, S.-C., & Hung, C.-W. (2016). Elucidating the factors influencing the acceptance of green products: An extension of theory of planned behavior. *Technological Forecasting and Social Change*, 112, 155–163. <https://doi.org/10.1016/j.techfore.2016.08.022>
- Childers, C. C., Lemon, L. L., & Hoy, M. G. (2019). #Sponsored #Ad: Agency Perspective on Influencer Marketing Campaigns. *Journal of Current Issues & Research in Advertising*, 40(3), 258–274. <https://doi.org/10.1080/10641734.2018.1521113>
- Chuah, S. H.-W., El-Manstrly, D., Tseng, M.-L., & Ramayah, T. (2020). Sustaining customer engagement behavior through corporate social responsibility: The roles of environmental concern and green trust. *Journal of Cleaner Production*, 262, 121348. <https://doi.org/10.1016/j.jclepro.2020.121348>
- Costa, C. S. R., Costa, M. F. da, Maciel, R. G., Aguiar, E. C., & Wanderley, L. O. (2021). Consumer antecedents towards green product purchase intentions. *Journal of Cleaner Production*, 313, 127964. <https://doi.org/10.1016/j.jclepro.2021.127964>
- Crilly, R., & Gillespie, M. (2019). What to do about social media? Politics, populism and journalism. *Journalism*, 20(1), 173–176. <https://doi.org/10.1177/1464884918807344>



- Czarnecka, M., Kinelski, G., Stefańska, M., Grzesiak, M., & Budka, B. (2022). Social Media Engagement in Shaping Green Energy Business Models. *Energies*, *15*(5), 1727. <https://doi.org/10.3390/en15051727>
- Dagher, G. K., & Itani, O. (2014). Factors influencing green purchasing behaviour: Empirical evidence from the Lebanese consumers. *Journal of Consumer Behaviour*, *13*(3), 188–195. <https://doi.org/10.1002/cb.1482>
- Dash, G., Kiefer, K., & Paul, J. (2021). Marketing-to-Millennials: Marketing 4.0, customer satisfaction and purchase intention. *Journal of Business Research*, *122*, 608–620. <https://doi.org/10.1016/j.jbusres.2020.10.016>
- Dhawan, S. (2020). Online Learning: A Panacea in the Time of COVID-19 Crisis. *Journal of Educational Technology Systems*, *49*(1), 5–22. <https://doi.org/10.1177/0047239520934018>
- Digital Report. (2022). *Digital 2022: Another Year of Bumper Growth*. <https://wearesocial.com/uk/blog/2022/01/digital-2022-another-year-of-bumper-growth-2/>
- ElHaffar, G., Durif, F., & Dubé, L. (2020). Towards closing the attitude-intention-behavior gap in green consumption: A narrative review of the literature and an overview of future research directions. *Journal of Cleaner Production*, *275*, 122556. <https://doi.org/10.1016/j.jclepro.2020.122556>
- F. Hair Jr, J., Sarstedt, M., Hopkins, L., & G. Kuppelwieser, V. (2014). Partial least squares structural equation modeling (PLS-SEM). *European Business Review*, *26*(2), 106–121. <https://doi.org/10.1108/EBR-10-2013-0128>
- Filo, K., Lock, D., & Karg, A. (2015). Sport and social media research: A review. *Sport Management Review*, *18*(2), 166–181. <https://doi.org/10.1016/j.smr.2014.11.001>
- Fiore, M., Silvestri, R., Contò, F., & Pellegrini, G. (2017). Understanding the relationship between green approach and marketing innovations tools in the wine sector. *Journal of Cleaner Production*, *142*, 4085–4091. <https://doi.org/10.1016/j.jclepro.2016.10.026>
- Fornell, C., & Larcker, D. F. (1981). Evaluating Structural Equation Models with Unobservable Variables and Measurement Error. *Journal of Marketing Research*, *18*(1), 39–50. <https://doi.org/10.1177/002224378101800104>
- Fraccastoro, S., Gabrielsson, M., & Pullins, E. B. (2021). The integrated use of social media, digital, and traditional communication tools in the B2B sales process of international SMEs. *International Business Review*, *30*(4), 101776. <https://doi.org/10.1016/j.ibusrev.2020.101776>
- Gartner, J., Fink, M., Floh, A., & Eggers, F. (2021). Service quality in social media communication of NPOs: The moderating effect of channel choice. *Journal of Business Research*, *137*, 579–587. <https://doi.org/10.1016/j.jbusres.2021.08.026>

- Guan, C., Liu, W., & Cheng, J. Y.-C. (2022). Using Social Media to Predict the Stock Market Crash and Rebound amid the Pandemic: The Digital 'Haves' and 'Have-mores.' *Annals of Data Science*, 9(1), 5–31. <https://doi.org/10.1007/s40745-021-00353-w>
- Guerreiro, J., & Pacheco, M. (2021). How Green Trust, Consumer Brand Engagement and Green Word-of-Mouth Mediate Purchasing Intentions. *Sustainability*, 13(14), 7877. <https://doi.org/10.3390/su13147877>
- Haenlein, M., Anadol, E., Farnsworth, T., Hugo, H., Hunichen, J., & Welte, D. (2020). Navigating the New Era of Influencer Marketing: How to be Successful on Instagram, TikTok, & Co. *California Management Review*, 63(1), 5–25. <https://doi.org/10.1177/0008125620958166>
- Hair, J. F., Anderson, R. E., Babin, B. J., & Black, W. C. (2010). *Multivariate data analysis: A global perspective* (Vol. 7). Pearson Upper Saddle River.
- Hair, J. F., Ringle, C. M., & Sarstedt, M. (2011). PLS-SEM: Indeed a Silver Bullet. *Journal of Marketing Theory and Practice*, 19(2), 139–152. <https://doi.org/10.2753/MTP1069-6679190202>
- Han, X., Hua, E., Engel, B. A., Guan, J., Yin, J., Wu, N., Sun, S., & Wang, Y. (2022). Understanding implications of climate change and socio-economic development for the water-energy-food nexus: A meta-regression analysis. *Agricultural Water Management*, 269, 107693. <https://doi.org/10.1016/j.agwat.2022.107693>
- Hsu, C.-L., Chang, C.-Y., & Yansritakul, C. (2017). Exploring purchase intention of green skincare products using the theory of planned behavior: Testing the moderating effects of country of origin and price sensitivity. *Journal of Retailing and Consumer Services*, 34, 145–152. <https://doi.org/10.1016/j.jretconser.2016.10.006>
- Huang, Y.-C. (2022). How marketing strategy, perceived value and brand image influence WOM outcomes—The sharing economy perspective. *Journal of Retailing and Consumer Services*, 68, 103071. <https://doi.org/10.1016/j.jretconser.2022.103071>
- Hulland, J., & Houston, M. (2021). The importance of behavioral outcomes. *Journal of the Academy of Marketing Science*, 49(3), 437–440. <https://doi.org/10.1007/s11747-020-00764-w>
- Hysa, B., Karasek, A., & Zdonek, I. (2021). Social Media Usage by Different Generations as a Tool for Sustainable Tourism Marketing in Society 5.0 Idea. *Sustainability*, 13(3), 1018. <https://doi.org/10.3390/su13031018>
- Ibrahim, B., & Aljarah, A. (2021). The era of Instagram expansion: matching social media marketing activities and brand loyalty through customer relationship quality. *Journal of Marketing Communications*, 1–25. <https://doi.org/10.1080/13527266.2021.1984279>
- Ibrahim, B., Aljarah, A., & Sawaftah, D. (2021). Linking Social Media Marketing Activities to Revisit Intention through Brand Trust and Brand Loyalty

- on the Coffee Shop Facebook Pages: Exploring Sequential Mediation Mechanism. *Sustainability*, 13(4), 2277. <https://doi.org/10.3390/su13042277>
- Jacobson, J., Gruzd, A., & Hernández-García, Á. (2020). Social media marketing: Who is watching the watchers? *Journal of Retailing and Consumer Services*, 53, 101774. <https://doi.org/10.1016/j.jretconser.2019.03.001>
- Jaiswal, D., & Kant, R. (2018a). Green purchasing behaviour: A conceptual framework and empirical investigation of Indian consumers. *Journal of Retailing and Consumer Services*, 41, 60–69. <https://doi.org/10.1016/j.jretconser.2017.11.008>
- Jaiswal, D., & Kant, R. (2018b). Green purchasing behaviour: A conceptual framework and empirical investigation of Indian consumers. *Journal of Retailing and Consumer Services*, 41, 60–69. <https://doi.org/10.1016/j.jretconser.2017.11.008>
- Jiménez-Zarco, A. I., Rospigliosi, A., Martínez-Ruiz, M. P., & Izquierdo-Yusta, A. (2019). Marketing 4.0. In *Web Services* (pp. 2172–2195). IGI Global. <https://doi.org/10.4018/978-1-5225-7501-6.ch113>
- Joshi, Y., Uniyal, D. P., & Sangroya, D. (2021). Investigating consumers' green purchase intention: Examining the role of economic value, emotional value and perceived marketplace influence. *Journal of Cleaner Production*, 328, 129638. <https://doi.org/10.1016/j.jclepro.2021.129638>
- Kartajaya, H., Kotler, P. , & Setiawan, I. (2016). *Marketing 4.0: moving from traditional to digital*. John Wiley & Sons.
- Khalifeh Soltani, S. R., Mostafaeipour, A., Almutairi, K., Hosseini Dehshiri, S. J., Hosseini Dehshiri, S. S., & Techato, K. (2022). Predicting effect of floating photovoltaic power plant on water loss through surface evaporation for wastewater pond using artificial intelligence: A case study. *Sustainable Energy Technologies and Assessments*, 50, 101849. <https://doi.org/10.1016/j.seta.2021.101849>
- Kim, A. J., & Ko, E. (2012). Do social media marketing activities enhance customer equity? An empirical study of luxury fashion brand. *Journal of Business Research*, 65(10), 1480–1486. <https://doi.org/10.1016/j.jbusres.2011.10.014>
- Kotler, P. (2017). Philip Kotler: some of my adventures in marketing. *Journal of Historical Research in Marketing*, 9(2), 203–208. <https://doi.org/10.1108/JHRM-11-2016-0027>
- Kotler, P. (2018). Why broadened marketing has enriched marketing. *AMS Review*, 8(1–2), 20–22. <https://doi.org/10.1007/s13162-018-0112-4>
- Kumar, N., & Mohan, D. (2021). Sustainable apparel purchase intention: collectivist cultural orientation and price sensitivity in extended TPB model. *Journal of Revenue and Pricing Management*, 20(2), 149–161. <https://doi.org/10.1057/s41272-021-00297-z>

- Li, G., Wu, H., Sethi, S. P., & Zhang, X. (2021). Contracting green product supply chains considering marketing efforts in the circular economy era. *International Journal of Production Economics*, 234, 108041. <https://doi.org/10.1016/j.ijpe.2021.108041>
- Lin, C. A., & Kim, T. (2016). Predicting user response to sponsored advertising on social media via the technology acceptance model. *Computers in Human Behavior*, 64, 710–718. <https://doi.org/10.1016/j.chb.2016.07.027>
- Liu, J., & Ye, Q. (2016). *How Price Affect Online Purchase Behavior in Online Healthcare Consulting? Perceived Quality as a Mediator* (pp. 196–203). [https://doi.org/10.1007/978-3-319-29175-8\\_18](https://doi.org/10.1007/978-3-319-29175-8_18)
- Loureiro, S. M. C., Serra, J., & Guerreiro, J. (2019). How Fashion Brands Engage on Social Media: A Netnography Approach. *Journal of Promotion Management*, 25(3), 367–378. <https://doi.org/10.1080/10496491.2019.1557815>
- Martens, B., Aguiar, L., GGmez, E., & Mueller-Langer, F. (2018). The Digital Transformation of News Media and the Rise of Disinformation and Fake News. *SSRN Electronic Journal*. <https://doi.org/10.2139/ssrn.3164170>
- Mason, A. N., Narcum, J., & Mason, K. (2021). Social media marketing gains importance after Covid-19. *Cogent Business & Management*, 8(1). <https://doi.org/10.1080/23311975.2020.1870797>
- Molajou, A., Afshar, A., Khosravi, M., Soleimani, E., Vahabzadeh, M., & Variani, H. A. (2021). A new paradigm of water, food, and energy nexus. *Environmental Science and Pollution Research*. <https://doi.org/10.1007/s11356-021-13034-1>
- Moon, S.-J. (2021). Effect of consumer environmental propensity and innovative propensity on intention to purchase electric vehicles: Applying an extended theory of planned behavior. *International Journal of Sustainable Transportation*, 1–15. <https://doi.org/10.1080/15568318.2021.1961950>
- Morkunas, V. J., Paschen, J., & Boon, E. (2019). How blockchain technologies impact your business model. *Business Horizons*, 62(3), 295–306. <https://doi.org/10.1016/j.bushor.2019.01.009>
- Moser, A. K. (2015). Thinking green, buying green? Drivers of pro-environmental purchasing behavior. *Journal of Consumer Marketing*, 32(3), 167–175. <https://doi.org/10.1108/JCM-10-2014-1179>
- Moser, A. K. (2016). Consumers' purchasing decisions regarding environmentally friendly products: An empirical analysis of German consumers. *Journal of Retailing and Consumer Services*, 31, 389–397. <https://doi.org/10.1016/j.jretconser.2016.05.006>
- Mostafa, M. M. (2007). Gender differences in Egyptian consumers? green purchase behaviour: the effects of environmental knowledge, concern and attitude. *International Journal of Consumer Studies*, 31(3), 220–229. <https://doi.org/10.1111/j.1470-6431.2006.00523.x>

- Murwaningtyas, F., Harisudin, M., & Irianto, H. (2020). Effect of Celebrity Endorser Through Social Media on Organic Cosmetic Purchasing Intention Mediated with Attitude. *KnE Social Sciences*. <https://doi.org/10.18502/kss.v4i3.6393>
- Nanda, A., Xu, Y., & Zhang, F. (2021). How would the COVID-19 pandemic reshape retail real estate and high streets through acceleration of E-commerce and digitalization? *Journal of Urban Management*, 10(2), 110–124. <https://doi.org/10.1016/j.jum.2021.04.001>
- Nash, J. (2019). Exploring how social media platforms influence fashion consumer decisions in the UK retail sector. *Journal of Fashion Marketing and Management: An International Journal*, 23(1), 82–103. <https://doi.org/10.1108/JFMM-01-2018-0012>
- Orben, A. (2020). Teenagers, screens and social media: a narrative review of reviews and key studies. *Social Psychiatry and Psychiatric Epidemiology*, 55(4), 407–414. <https://doi.org/10.1007/s00127-019-01825-4>
- Paul, J., Modi, A., & Patel, J. (2016a). Predicting green product consumption using theory of planned behavior and reasoned action. *Journal of Retailing and Consumer Services*, 29, 123–134. <https://doi.org/10.1016/j.jretconser.2015.11.006>
- Paul, J., Modi, A., & Patel, J. (2016b). Predicting green product consumption using theory of planned behavior and reasoned action. *Journal of Retailing and Consumer Services*, 29, 123–134. <https://doi.org/10.1016/j.jretconser.2015.11.006>
- Peeters, W. (2018). Applying the networking power of Web 2.0 to the foreign language classroom: a taxonomy of the online peer interaction process. *Computer Assisted Language Learning*, 31(8), 905–931. <https://doi.org/10.1080/09588221.2018.1465982>
- Philp, M., Jacobson, J., & Pancer, E. (2022). Predicting social media engagement with computer vision: An examination of food marketing on Instagram. *Journal of Business Research*, 149, 736–747. <https://doi.org/10.1016/j.jbusres.2022.05.078>
- Pop, R.-A., Săplăcan, Z., & Alt, M.-A. (2020). Social Media Goes Green—The Impact of Social Media on Green Cosmetics Purchase Motivation and Intention. *Information*, 11(9), 447. <https://doi.org/10.3390/info11090447>
- Prestridge, S. (2019). Categorising teachers' use of social media for their professional learning: A self-generating professional learning paradigm. *Computers & Education*, 129, 143–158. <https://doi.org/10.1016/j.compedu.2018.11.003>
- Rausch, T. M., & Kopplin, C. S. (2021). Bridge the gap: Consumers' purchase intention and behavior regarding sustainable clothing. *Journal of Cleaner Production*, 278, 123882. <https://doi.org/10.1016/j.jclepro.2020.123882>

- Ruckenstein, M., & Granroth, J. (2020). Algorithms, advertising and the intimacy of surveillance. *Journal of Cultural Economy*, 13(1), 12–24. <https://doi.org/10.1080/17530350.2019.1574866>
- Saari, U. A., Damberg, S., Frömbing, L., & Ringle, C. M. (2021). Sustainable consumption behavior of Europeans: The influence of environmental knowledge and risk perception on environmental concern and behavioral intention. *Ecological Economics*, 189, 107155. <https://doi.org/10.1016/j.ecolecon.2021.107155>
- Salem, S. F., & Alanadoly, A. B. (2021). Personality traits and social media as drivers of word-of-mouth towards sustainable fashion. *Journal of Fashion Marketing and Management: An International Journal*, 25(1), 24–44. <https://doi.org/10.1108/JFMM-08-2019-0162>
- Săplăcan, Z., & Márton, B. (2019). Determinants of Adopting a Zero Waste Consumer Lifestyle. *Regional and Business Studies*, 11(2). <https://doi.org/10.33568/rbs.2410>
- Saura, J. R., Palacios-Marqués, D., & Ribeiro-Soriano, D. (2022). Exploring the boundaries of open innovation: Evidence from social media mining. *Technovation*, 102447. <https://doi.org/10.1016/j.technovation.2021.102447>
- Sedalo, G., Boateng, H., & Kosiba, J. P. (2022). Exploring social media affordance in relationship marketing practices in SMEs. *Digital Business*, 2(1), 100017. <https://doi.org/10.1016/j.digbus.2021.100017>
- Sellitto, M. A., Camfield, C. G., & Buzuku, S. (2020). Green innovation and competitive advantages in a furniture industrial cluster: A survey and structural model. *Sustainable Production and Consumption*, 23, 94–104. <https://doi.org/10.1016/j.spc.2020.04.007>
- Senthil Raja, M., & Arun Raj, L. (2021). Detection of Malicious Profiles and Protecting Users in Online Social Networks. *Wireless Personal Communications*. <https://doi.org/10.1007/s11277-021-08095-x>
- Seo, E. J., Park, J.-W., & Choi, Y. J. (2020a). The Effect of Social Media Usage Characteristics on e-WOM, Trust, and Brand Equity: Focusing on Users of Airline Social Media. *Sustainability*, 12(4), 1691. <https://doi.org/10.3390/su12041691>
- Seo, E. J., Park, J.-W., & Choi, Y. J. (2020b). The Effect of Social Media Usage Characteristics on e-WOM, Trust, and Brand Equity: Focusing on Users of Airline Social Media. *Sustainability*, 12(4), 1691. <https://doi.org/10.3390/su12041691>
- Sharma, N., Saha, R., Sreedharan, V. R., & Paul, J. (2020). Relating the role of green self-concepts and identity on green purchasing behaviour: An empirical analysis. *Business Strategy and the Environment*, 29(8), 3203–3219. <https://doi.org/10.1002/bse.2567>
- Sniehotta, F. F., Scholz, U., & Schwarzer, R. (2005). Bridging the intention–behaviour gap: Planning, self-efficacy, and action control in the adoption

- and maintenance of physical exercise. *Psychology & Health*, 20(2), 143–160. <https://doi.org/10.1080/08870440512331317670>
- Sun, Y., & Wang, S. (2019). Understanding consumers' intentions to purchase green products in the social media marketing context. *Asia Pacific Journal of Marketing and Logistics*, 32(4), 860–878. <https://doi.org/10.1108/APJML-03-2019-0178>
- Sustainable fashion worldwide Report. (2022). *Sustainable fashion worldwide*. <https://www.statista.com/study/111665/sustainable-fashion-worldwide/>
- Swaminathan, V., Sorescu, A., Steenkamp, J.-B. E. M., O'Guinn, T. C. G., & Schmitt, B. (2020). Branding in a Hyperconnected World: Refocusing Theories and Rethinking Boundaries. *Journal of Marketing*, 84(2), 24–46. <https://doi.org/10.1177/0022242919899905>
- Tabachnick, B. G., Fidell, L. S., & Ullman, J. B. (2007). *Using multivariate statistics* (SEVENTH EDITION). MA: pearson. <https://lccn.loc.gov/2017040173>
- Teixeira, A. A., Jabbour, C. J. C., & Jabbour, A. B. L. de S. (2012). Relationship between green management and environmental training in companies located in Brazil: A theoretical framework and case studies. *International Journal of Production Economics*, 140(1), 318–329. <https://doi.org/10.1016/j.ijpe.2012.01.009>
- Tseng, M.-L., Chiu, (Anthony) Shun Fung, Tan, R. R., & Siriban-Manalang, A. B. (2013). Sustainable consumption and production for Asia: sustainability through green design and practice. *Journal of Cleaner Production*, 40, 1–5. <https://doi.org/10.1016/j.jclepro.2012.07.015>
- Tu, J.-C., Chan, H.-C., & Chen, C.-H. (2020). Establishing Circular Model and Management Benefits of Enterprise from the Circular Economy Standpoint: A Case Study of Chyhjiun Jewelry in Taiwan. *Sustainability*, 12(10), 4146. <https://doi.org/10.3390/su12104146>
- Varah, F., Mahongnao, M., Pani, B., & Khamrang, S. (2021). Exploring young consumers' intention toward green products: applying an extended theory of planned behavior. *Environment, Development and Sustainability*, 23(6), 9181–9195. <https://doi.org/10.1007/s10668-020-01018-z>
- Vermeir, I., & Verbeke, W. (2006). Sustainable Food Consumption: Exploring the Consumer “Attitude – Behavioral Intention” Gap. *Journal of Agricultural and Environmental Ethics*, 19(2), 169–194. <https://doi.org/10.1007/s10806-005-5485-3>
- Wang, M., Li, Y., Li, J., & Wang, Z. (2021). Green process innovation, green product innovation and its economic performance improvement paths: A survey and structural model. *Journal of Environmental Management*, 297, 113282. <https://doi.org/10.1016/j.jenvman.2021.113282>
- Wang, Z., Tchernev, J. M., & Solloway, T. (2012). A dynamic longitudinal examination of social media use, needs, and gratifications among college



- students. *Computers in Human Behavior*, 28(5), 1829–1839. <https://doi.org/10.1016/j.chb.2012.05.001>
- Webb, T. L., & Sheeran, P. (2006). Does changing behavioral intentions engender behavior change? A meta-analysis of the experimental evidence. *Psychological Bulletin*, 132(2), 249–268. <https://doi.org/10.1037/0033-2909.132.2.249>
- Wereda, W., & Woźniak, J. (2019). Building Relationships with Customer 4.0 in the Era of Marketing 4.0: The Case Study of Innovative Enterprises in Poland. *Social Sciences*, 8(6), 177. <https://doi.org/10.3390/socsci8060177>
- Wijekoon, R., & Sabri, M. F. (2021). Determinants That Influence Green Product Purchase Intention and Behavior: A Literature Review and Guiding Framework. *Sustainability*, 13(11), 6219. <https://doi.org/10.3390/su13116219>
- Yadav, R., & Pathak, G. S. (2016a). Intention to purchase organic food among young consumers: Evidences from a developing nation. *Appetite*, 96, 122–128. <https://doi.org/10.1016/j.appet.2015.09.017>
- Yadav, R., & Pathak, G. S. (2016b). Young consumers' intention towards buying green products in a developing nation: Extending the theory of planned behavior. *Journal of Cleaner Production*, 135, 732–739. <https://doi.org/10.1016/j.jclepro.2016.06.120>
- Yadav, R., & Pathak, G. S. (2017a). Determinants of Consumers' Green Purchase Behavior in a Developing Nation: Applying and Extending the Theory of Planned Behavior. *Ecological Economics*, 134, 114–122. <https://doi.org/10.1016/j.ecolecon.2016.12.019>
- Yadav, R., & Pathak, G. S. (2017b). Determinants of Consumers' Green Purchase Behavior in a Developing Nation: Applying and Extending the Theory of Planned Behavior. *Ecological Economics*, 134, 114–122. <https://doi.org/10.1016/j.ecolecon.2016.12.019>
- Youn, C., & Jung, H. J. (2021). Semantic Network Analysis to Explore the Concept of Sustainability in the Apparel and Textile Industry. *Sustainability*, 13(7), 3813. <https://doi.org/10.3390/su13073813>
- Zahan, I., Chuanmin, S., Fayyaz, M., & Hafeez, M. (2020). Green purchase behavior towards green housing: an investigation of Bangladeshi consumers. *Environmental Science and Pollution Research*, 27(31), 38745–38757. <https://doi.org/10.1007/s11356-020-09926-3>



“

## Chapter 7

**ASABIYYA AS A USEFUL CONCEPTUAL  
TOOL FOR THE PALESTINIAN CASE**

*Abdurrahman GÜMÜŞ<sup>1\*</sup>*

”

---

<sup>1</sup> Dr., Yildiz Technical University Political Science and International Relations Department, abdurrahmangumus001@gmail.com, ORCID: 0000-0002-1746-7876

## 1. INTRODUCTION

Ibn Khaldun's concept of *asabiyya* can be used in the Palestinian case due to some important aspects of the Middle Eastern context and the policies of the Palestinian actors. Before using the concept about the Palestinian case, it will be better to put forward the meanings and implications of *asabiyya*. It can be claimed that a clear-cut definition of *asabiyya* does not take place even in Ibn Khaldun's famous work, *the Muqaddimah*. However, Ibn Khaldun explains the different effects of *asabiyya* and the context which it originated from in detail. Ibn Khaldun uses the concept in the meaning of "having power and a large social base which provides superiority in the society" (Ibn Khaldun, 2004: 69). In the most basic sense, *asabiyya* can be defined as a "strong group feeling" (Ardic, 2012: 316). It is translated into English with different expressions such as group feeling, corporate spirit, feeling of solidarity, communal spirit, and social cohesion. The concept of *asabiyya* offers more than each of these expressions and it certainly has more meanings in the Ibn Khaldunian sense.

For Ibn Khaldun, the impact of this feeling of solidarity increases through consanguineous and tribal relations but they are not the only sources of *asabiyya*. Albert Hourani uses the concept in the meaning of "a corporate spirit oriented towards obtaining and keeping power" (Rosen, 2005: 597). This definition refers to the central place of political leadership and the goal of political authority in the concept of *asabiyya*. In other words, the corporate spirit or group solidarity that unifies the group members requires a common goal of establishing political authority to turn into *asabiyya*. Therefore, the group having superiority in the society in terms of power and influence deserves to establish authority and lead other groups as long as they keep *asabiyya* in their hands (Ibn Khaldun, 2004: 176). While kindredship naturally provides a source of unity among people, sharing the same living place may also lead to a high amount of solidarity (Meric, 2006: 152–153). Cherkaoui defines it as a "unifying, inspiring, and empowering force among the group members", and he explains the complexity of the concept in detail: "*Asabiya* is more than solidarity; it constitutes multiple bonds that hold a social group together and sustains a certain lifestyle, culture, and influence of the group" (26–27). This explanation points out the concept's political, moral, and socio-cultural aspects.

*Asabiyya* takes place at the heart of sovereignty for all types of social organizations, including the state. Oliver Roy addresses the need for focusing on the contextual peculiarities to grasp the reality on the ground and claims that the state in the Middle East cannot be thoroughly understood "without reference to the loci of personal allegiances created by solidarity groups (*asabiyya*), networks and communities (particularly

religious ones)” (Volpi, 2004: 1065). Put differently, it is necessary to take into account the personal relations and the relations among different groups and communities for analyzing the Middle Eastern and North African (MENA) context. For example, the Libyan state under the leadership of Qaddafi or the Syrian state under the leadership of the Asad family was very different from their Western counterparts in terms of state formations and state-society relations despite the existence of some similarities. The states in the Middle East were depicted as “neo-patrimonial regimes with cohesive elite cores based on *asabiyya* (primordial solidarity) governing via clientelism, bureaucratic institutions, *mukhabarat* surveillance and welfare entitlements for the masses” (Hinnebusch, 2014: 9). For the Arab societies and cultures, *asabiyya* is defined as “a solidarity or identity group based on real or imagined blood or primordial ties, strengthened by actual or invented common ancestry” and “an authentic pattern of nationalism” (Kimmerling, 2000: 50–52). As a result, *asabiyya* and some other concepts referring to these contextual peculiarities can be used for understanding the cases in those contexts. Such cultural or region-specific concepts can be combined with structural analyses to see the differences as well as similarities.

In its conventional use, *asabiyya* is associated with the Bedouin lifestyle and tribal organization. Although the lifestyles of Arab communities today are generally different from the period in which Ibn Khaldun lived, there are certain similarities, especially in some countries in the Middle East and North Africa. Moreover, this aspect makes the concept more useful for Middle Eastern and North African cases compared to other regions. *Asabiyya* binds people through some commonalities such as language, culture, or lifestyle. Ibn Khaldun’s concept of *asabiyya* is sometimes identified with Durkheim’s concepts of “mechanical” or “organic solidarity” (Tomar, 2008: 605). Because of the similarities between the living conditions of Bedouins and tribes, the concept of *asabiyya* is often confused with tribalism but in the modern world, the terms Bedouin or tribal refer to “acceptance of a special code of behavior and adherence to specific social values rather than a certain lifestyle” (Maisel, 2014: 104–105). It implies that today’s tribes may include both pastoral and sedentary lifestyles so tribalism does not directly lead to the emergence of *asabiyya* among their members. However, it still creates some opportunities for establishing group solidarity among their members with the help of shared values and goals, coexistence, and meeting their demands together. Put differently, tribalism should not be confused with the concept of *asabiyya* in the modern world but the changes in the lifestyles of different groups of people should be taken into account to apply the concept to practical cases.

For Ahmed, *asabiyya* in the Muslim world was damaged after the mid-20<sup>th</sup> century as a result of some political developments including the creation of Israel (31). This expression shows the importance of political developments for either the emergence or breaking down of *asabiyya*, and it also underlines the creation of Israel as one of the most central developments in the region. Different factors play role in the emergence of *asabiyya*. Ibn Khaldun appreciates even “war as a political instrument for advancement of civilized culture” (Mufti, 2009: 409). Warfare is a model of statecraft as a whole in the Ibn Khaldunian approach. However, Abozeid points out the need for “deconstructing material and discursive structures of despotism, repression, and state violence” to understand Ibn Khaldun’s theoretical approach explaining the relationship between authority, legitimacy, and state violence and to apply this theory in the modern Arab world (168). As a result, *asabiyya* causes a group of people to act collectively under the influence of certain factors and it provides a spirit of unity and solidarity for these people.

Ibn Khaldun explains the concept of *asabiyya* as “an explicitly political phenomenon that under certain conditions can be exploited and mobilized to achieve political ends” (Goldsmith, 2013: 393). This expression shows the possibility of using *asabiyya* as a way of bringing people together to realize particular political purposes. *Asabiyya* can be used as a significant tool for a region where the population is overwhelmingly composed of a group of people having similar ethnic, religious, and identity backgrounds and living under the occupation of external power. Getting rid of the occupation and establishing their independent and sovereign state provides the required motivation for these people. Therefore, the Palestinian case presents a perfect example of using *asabiyya* with all its components and derivations. Because of the apparent reasons for the mobilization of people, the emergence of different groups for some political goals is undeniable. However, their policies, interests, discourses, and activities may clash with one another as can be observed in the Palestinian case. This situation should not be directly considered as the exploitation of *asabiyya* by some groups but this possibility should always be kept in mind. The more powerful or superior group outweighs the other at the end of this struggle throughout history and it maintains its dominance as long as it has the superior *asabiyya*. As a result, the Palestinian case offers a test for Ibn Khaldun’s approach based on *asabiyya* in the Middle Eastern context.

The dichotomy between nomadic and sedentary lifestyles is of crucial significance for Ibn Khaldun’s perspective due to the impact of lifestyle on the characteristics of the group of people. According to Ibn Khaldun, the nomadic people having *asabiyya* would certainly override the sedentary people without *asabiyya*. *Asabiyya* was interpreted as “the glue that held

societies together” and it was based on “kinship and religion and stronger in tribal than in urban society” (Darling, 2007: 329). The close relationship between the nomadic lifestyle and the creation of asabiyya among members can be understood because of the likelihood of having a corporate spirit or group solidarity in nomadic life naturally. However, the concept of asabiyya cannot be identified with a particular lifestyle. For instance, a sedentary group of people might have asabiyya and it may outweigh several other nomadic groups as long as it keeps its superiority based on its asabiyya. Therefore, the concept of asabiyya should not be associated with a certain lifestyle, especially in the modern world where nomadic people constitute a small minority and there is almost no example of nomadic groups having political authority in the regional sense. Toynbee also rejects the idea that “asabiyya was virtually a monopoly of the nomads” and deplors the absence of urban communities having asabiyya in Ibn Khaldun’s analysis (Irwin, 1997: 468). Ibn Khaldun certainly depicted the relations in the period in which he lived but his concept of asabiyya is not solely associated with nomads and he attributed different features to asabiyya. Thus, it should be considered a comprehensive concept with all its derivations and implications and it cannot be reduced to particular societies or lifestyles. Otherwise, it will hardly be applicable and useful for modern cases.

There is an intimate relationship between asabiyya and the state. For Ibn Khaldun, the ultimate goal of asabiyya is sovereignty (189). Put differently, the group solidarity among people stemming from sharing a particular living space and lifestyle as well as common cultural, religious, and moral values provides the required power for establishing a state and maintaining control and obedience among different segments of society. In the Ibn Khaldunian sense, asabiyya is a *sine qua non* for sovereignty leading to a state. Furthermore, Ibn Khaldun underlines the fact that a call for religion or religious values strengthens asabiyya which constitutes the basis of the state due to its unifying influence but it will not be sufficient without asabiyya (222–224). In the Palestinian case, the Islamist identity and principles of Hamas can be considered an advantage compared to the secular ideology of Fatah. Apart from that, the existence of competing asabiyyas in a particular region makes political stability difficult (Ibn Khaldun, 231). Therefore, Hamas-Fatah competition in Palestine does not serve the idea of an independent and sovereign Palestinian state. The power of asabiyya is based on its unifying impact among the members so the factors leading to the dissolution of unity block the realization of establishing a state. The concept of asabiyya can be regarded as a significant tool for explaining the current situation of the Palestinian groups and the failure of establishing a Palestinian state even after the various attempts

under the framework of the two-state solution. As a result, the disunity among the Palestinian groups and the failures of Palestinians in terms of having strong *asabiyya* are as important as external factors like the Israeli occupation.

Kayapinar offers *asabiyya* as an alternative conceptual tool in political theory and the liberal democratic paradigm (375). His explanations about the concept of *asabiyya* open a way for putting this concept in the Palestinian case. He addresses the central place of “close contact” and being outside (or being deprived of) in the emergence of *asabiyya* but the feeling of submission should come from inside, not from an outside power or a dominant authority. This detail is important for the Palestinian case which will be discussed in the next paragraphs. Lastly, he analyzes the relationship between *asabiyya* and sovereignty: “*Asabiyya* that is able to monopolise *mulk* exclusively is nothing but sovereignty” (Kayapinar, 2008: 398). In short, *asabiyya* refers to a strong group feeling or solidarity under the influence of different dynamics. The group members share the same feeling and this belonging directs them to act collectively. In the conventional meaning, *asabiyya* comes into being naturally; therefore, each member has to act together with other members to continue their lives against external threats. However, it becomes more complicated when this concept is used in the political contexts of the modern world.

## **2. RESEARCH METHOD, SOURCES, AND OUTLINE OF THE ARTICLE**

This article is based on explanatory research. Since the concept of *asabiyya* will be used for the Palestinian case, the case study will be the main method of the article. Ibn Khaldun’s work, the *Muqaddimah*, can be regarded as a primary source about the focus of the article and secondary sources analyzing the concept of *asabiyya* and the details of the Palestinian case will be extensively used in the article. The Palestinian case will be qualitatively analyzed by using the concept of *asabiyya* in the article.

In addition to the introduction part, in which I address the meaning and implications of the concept of *asabiyya* as well as the existing literature on the concept, and the conclusion part, the following paragraphs concentrating on the Palestinian case by using the concept of *asabiyya* will constitute the main part of the article. It will show how the concept of *asabiyya* is related to the Palestinian case and what kind of explanatory power it carries in terms of Palestinian politics.

### **3. THE PALESTINIAN CASE AND THE CONCEPT OF ASABIYYA**

Having mentioned the definitions and different implications of the concept of asabiyya basically, I will analyze the Palestinian case with the help of this meaningful concept. The historical evolution of the Israeli-Palestinian conflict shows that the struggles among the Arabs and Jewish people in the region turned into an Arab-Israeli conflict after the establishment of the State of Israel in 1948. Following the long period of military struggles, the two sides agreed on pursuing negotiations to reach a comprehensive settlement of the conflict after the 1973 Arab-Israeli War. In that period, the PLO was accepted as “the sole legitimate representative of the Palestinian people” by the UN and some regional organizations in 1974 so the negotiations started as a part of the Israeli-Palestinian conflict (Balpinar, 2019: 119). The negotiation phase also continued for a long time and it created some opportunities and improvements like mutual recognition of both sides during the Oslo process but they could not lead to a grand or comprehensive solution for the conflict (Balpinar, 198). The Palestinian people living in historic Palestine including today’s West Bank, Jerusalem, Gaza, and other occupied territories were the ones who felt the most desperate and cruel reflections of struggles in their daily lives directly under the Israeli occupation or against the Israeli attacks. In other words, the Israeli-Palestinian conflict has been a part of the lives and identities of the Palestinian people just because they were Palestinians and living in the “disputed” or “occupied” territories. “The cost of no agreement” did not mean status quo but deteriorating conditions for the Palestinians (Putnam, 1988: 442). This situation created a strong awareness, solidarity, and group feeling among the Palestinian people. Therefore, the concept of asabiyya, with its derivations and components, can be used as a promising tool for the Palestinian case. However, it does not mean that the Palestinians constitute a homogenous group, and asabiyya comes out of them naturally. On the contrary, there have been crucial disagreements among the Palestinians as well.

#### **3. 1. The Palestinian Liberation Organization (PLO) and Fatah**

The Palestinian Liberation Organization, which was mostly composed of Fatah members, under the leadership of Yasser Arafat gained the upper hand in Palestinian politics and it represented Palestinians in the negotiations in the first years of the negotiation period. It was established in 1964 but recognition of the PLO as the sole legitimate representative of Palestinians and gaining observer status at the UN by 1974 became a turning point not only for the history of the PLO but also for the evolution of the Palestinian struggle in the next period (Shemesh, 1984: 121). This



turning point was certainly a window of opportunity for Fatah under the leadership of Arafat. Representing Palestinians in the negotiations was both an important mission and responsibility for Arafat and the Fatah members and a useful means for gaining the support of all Palestinians. Until the establishment of the Palestinian Authority, the PLO functioned as a “state surrogate” for Palestinians and it neither supported nor blocked civil society in that period (Muslih, 1993: 271). During the Oslo process, the Palestinian Authority was established as an interim administrative body to prepare the ground for implementing the decisions agreed on by the two sides and accomplishing the institutional structure of a future Palestinian state (Balpınar, 202). To put it another way, the establishment of the Palestinian Authority strengthened the hands of Arafat and Fatah by providing some institutional means and financial resources.

Despite the initial expectations, Arafat preferred to consolidate his power in Palestinian politics by filling the administrative posts with the Fatah members and building a system based on patron-client relationships. It was claimed that “as the Palestinian Authority turned into a venal and authoritarian Arab Regime, the popularity of Islamist and fundamentalist militancy increased among Palestinians and Hamas benefited from that process” (Tschirgi, 2005-2006: 159). For example, the system and political culture established by the Palestinian Authority in Gaza before the 2006 elections were depicted with two principles: centralism and clientelism (Tuastad, 2010: 793). The political system under the leadership of the Palestinian Authority evolved from a strong presidential regime to a “semi-parliamentary regime” and ended in a “reconcentration of power in the president’s hands” in that period (Dabed, 2014: 43). However, these changes in the regime did not go beyond the regulations of the elite relations and they could not create the expected outcomes for the living conditions of Palestinians. Thus, the Palestinian Authority failed to meet the basic needs of the Palestinian people and provide the necessary services.

In addition to consolidating power, the existing system excluded some segments of society so they began to search for other alternatives among the Palestinian groups. As a result, the PLO missed an important opportunity and led to the rise of popularity and political appeal of other candidates in Palestinian politics. It should be noted that Arafat’s leadership and administrative style provided some advantages for their supporters and other groups, called “loyal opposition”, having close relations with Fatah (Sayigh, 1989: 249). This situation prevented the Palestinians from creating a strong *asabiyya* under the leadership of Fatah and Arafat but the Arafat period in Palestinian politics started a certain amount of polarization which paved the way for societal divisions among Palestinians. The rise of alternative groups contributed to the increase in polarization of society



and debates over separate asabiyyas between the two consolidated power bases in the following period. The West Bank is composed of fragmented territories today and establishing strong asabiyya under these conditions cannot be regarded as a plausible option.

Looking at the other side of the coin, the PLO under the leadership of Arafat made some important attempts to resolve the Israeli-Palestinian conflict. After long years of military struggle against Israel and internal debates in Palestinian politics, the PLO adopted a more pragmatic approach and goal-driven policies. Among these policies, the declaration of a Palestinian state in the West Bank and Gaza with East Jerusalem as its capital in 1988 under the framework of the two-state solution, renouncing the use of terror by the PLO, and mutual recognition of both sides in the Oslo process were the prominent and positive examples for the PLO leadership in favor of overcoming the barriers and resolution of the conflict (Golan, 2020: 38–39). Hamas opposed the Oslo Accords in that period.

### **3. 2. Hamas (The Islamic Resistance Movement)**

Hamas (the Islamic Resistance Movement) emerged as a significant Palestinian actor and a tough opponent for Fatah. The strict ideology of Hamas especially in the first years after its establishment and its military struggle against Israel created problems in terms of international legitimacy. Hamas was a result of a process based on a collective revolt and challenge against Israel and this collective movement and solidarity created the First Intifada. Hamas justified its military struggle with the insufficiency of political activities against the Israeli occupation (Ghazzal, 2005: 193). However, its military activities and military struggle against Israel were generally identified with terrorism by the international actors, and Hamas was put into the category of “terrorism associated with national liberation” because of those activities (Dalacoura, 2012: 103). More interestingly, even though Hamas was the Palestinian branch of the Muslim Brotherhood, it differed from the general Muslim Brotherhood ideology prioritizing the Islamization of society rather than directly engaging in a military struggle because of the urgent needs of the Palestinian people against the reality of Israeli occupation on the ground. Put differently, the emergence of Hamas reflected the mood of ordinary Palestinians so it became a prominent actor in Palestinian politics. Looking at the other side of the coin, Hamas could increase its support base among Palestinians with the help of social services by filling the vacuum stemming from insufficient activities and the controversial administrative style of the Palestinian Authority.

Despite the increasing support base among Palestinians, Hamas categorically rejected participation in the general elections due to its political stance and questions about the legitimacy of the political system

and elections until 2006. The Hamas leaders decided to participate in the 2006 elections and they put forward some reasons for the change in their position. The change in Hamas's electoral strategy was explained through different reasons such as "the change in the dominant faction among the Hamas members, the suspension of Oslo, increasing popularity of Hamas and poor performance of the PA [Palestinian Authority]" (Lovlie, 2013: 583; Klein, 2007: 445; Rabbani, 2008: 68). Hamas could get an unexpected political victory in the elections. The spokespeople of Hamas declared the first signs of political flexibility during and after the elections, and the discursive shift of Hamas was observed in the Hamas documents in that period but these attempts could not convince the Fatah members (Hroub, 2006: 7). Thus, the election victory of Hamas created a polarized atmosphere in Palestinian society. The conflict between Hamas and Fatah members ended in the takeover of Gaza by Hamas in 2007. After the removal of the Fatah forces from Gaza as a result of the domestic struggle among the Palestinians, a de facto geographical and political split emerged between the West Bank under the control of Fatah and Gaza under the control of Hamas.

### **3. 3. The Split between the Palestinian Groups and Its Impact on Asabiyya**

The geographic and political split between Hamas and Fatah has damaged the emergence of asabiyya among all the Palestinians. However, the clear division between the two groups, Hamas and Fatah, opened the way for establishing their asabiyyas among their supporters. Ibn Khaldun explains the transformation of power relations in a particular region with a dominant group and emerging ones so that the superior actor establishes the asabiyya which is the driving force for the people living in there. The political struggle among the Palestinian groups can be considered from that perspective. As was mentioned above, submission to a group that may likely lead to asabiyya should come from inside, it cannot be imposed from above. In Palestinian politics, there was a balance of power among various groups before the Hamas-Fatah competition; therefore, no group could dominate the others and had a strong asabiyya but it was claimed that the clientelist politics of the Palestinian Authority broke this balance (Tuastad, 794). While the Fatah and its allies were in power in that period, the changing power relations and dynamics on the ground led to unexpected consequences for them. The Palestinian Authority was also supported by international actors and local powerful allies but the exclusion of other groups in the society led to the decline of their popularity and failures in the elections. Consequently, Hamas-Fatah split in the territories of Gaza and the West Bank has damaged the possible strong asabiyya among all the Palestinians and led to the attempts to create their asabiyyas in the two

separate territories. There are different dynamics and factors which may evolve in different directions but it has already created different proposals like a “three-state solution” for the Israeli-Palestinian conflict (Ben-Ami, 2019; Hacoheh, 2018; Danon, 2014).

Asabiyya is not only related to a claim for establishing a political order but also requires the creation of new identities and a cultural and moral order for its members. According to Cherkaoui, Hamas’s asabiyya is based on “constructing an Islamist cultural and moral order, developing Hamsawi identification, and controlling an exclusive territory beyond the traditional Palestinian social cohesion” (282). The Islamist cultural and moral order offered by Hamas was a real alternative and a direct challenge against the secular ideology of Fatah. Furthermore, the author asserts the Hamsawi identity as a rival to the Fathawi identity. He underlines the fact that “identification” as a process is a better concept instead of the static nature of “identity” because establishing asabiyya among a particular group of people is certainly a result of a process and that process is not smooth; on the contrary, it has some fluctuations. In other words, the struggle between two rival groups over the dominance of their political and moral orders may lead to favorable conditions for both sides in different contexts. Ibn Khaldun attributes a key role to religion in the creation of asabiyya (Tomar, 598). Compared to Fatah’s secular ideology, the Islamist cultural and moral order offered by Hamas and identity mostly based on religious principles can be considered as the advantage of Hamas in the competition in terms of creating their asabiyyas.

In the Palestinian case, Mahmoud Abbas and the Fatah group have the advantage of representing Palestinians in the international arena and negotiations; thus, a favorable outcome for Palestinians in international relations strengthens the Fatah position in the domestic struggle. “The logic of two-level games” works in the Palestinian case in that sense (Putnam, 427). For example, one of the reasons for Mahmoud Abbas’s application for Palestinian membership to the UN in 2011 was his decreasing popularity and political standing among Palestinians. Abbas aimed to gain prestige and support in Palestinian politics by taking a step forward in the international arena. Similarly, successful attempts or failures in domestic politics may lead to parallel results in the international arena. On the other hand, Hamas’s military struggle against Israel and the support of the Palestinian people for Hamas facilitate Hamas’s position and popularity. In addition to this, it was argued that Hamas’s asabiyya has a wide variety of factors such as “moral repositioning of Hamas, identification transformation, foreign linkages, Abbas’s leadership, de-development of Gaza, the Oslo process, and cultural innovation and religiosity” (Cherkaoui, 286). These

factors show the influence of the actions of a particular group as well as the impacts of external reasons.

In terms of the domestic struggle between Hamas and Fatah, the external actors preferred to increase their relations with the West Bank government and to support Abbas's leadership due to their suspicions towards Hamas so they adopted the West Bank First strategy and they maintained a low level of relations with Hamas even after the electoral victory of Hamas and its direct control in Gaza. However, the support of external actors may not lead to societal support for local actors, especially in cases of conflict. Despite the societal support for Hamas, the Gazan people had to live under difficulties due to the lack of sufficient administrative capabilities of Hamas and external support as well as recurring Israeli attacks on Gaza. Consequently, Hamas emerged as a significant actor against Fatah because of its political power and support base as well as its alternative identity and cultural and moral order; thus, these deeply-rooted differences increase the possibility and attempts for establishing their *asabiyyas*, especially after the geographical and political split. Ibn Khaldun underlines the importance of strong *asabiyya* for the emergence and maintenance of a state so the conditions in Palestinian politics do not serve the goal of a future Palestinian state in that regard.

Historically, the First and Second Intifadas constituted important steps in terms of collective reactions and movements of Palestinians against the Israeli occupation. The collective reaction of Palestinians and the involvement of various Palestinian groups by leaving aside the differences in their opinions created a feeling of solidarity and played a unifying role in that period. Hamas was established in the process of the First Intifada. The Second Intifada emerged after Sharon visited Temple Mount, which included the al-Aqsa Mosque, in September 2000. It was also called al-Aqsa Intifada. The two processes of the Intifadas served the collective consciousness of Palestinians and showed the likelihood of collective action in case of leaving aside the divisions among the Palestinian groups. In other words, the group solidarity and unification against a common target during the Intifada processes made the necessary conditions for the emergence of *asabiyya* among Palestinians more apparent. Therefore, it can be claimed that the collective movement of Palestinians during the Intifada processes proved the likelihood and possibility of common *asabiyya* among all Palestinians. However, the geographical and political split between the two prominent Palestinian groups in the later period went in the opposite direction and increased the divisions instead of unification. Consequently, the First and Second Intifadas facilitated the conditions which might lead to common *asabiyya* among Palestinians but the actions of the Palestinian groups could not support the gains of these processes and

increased the divisions.

In the current period, the Arab Uprisings initially created a favorable regional context for Palestinians parallel to the rise of the Muslim Brotherhood and other Islamist groups. The Palestinian leader Mahmoud Abbas applied to the UN for full membership in 2011. This application aimed to increase international support for the Palestinian cause and pave the way for a Palestinian state in the next period. However, the 2013 military intervention in Egypt created disappointment for both the PA and Hamas and it blocked the momentum for asserting the Palestinian cause with the help of regional transformation. Apart from that, Fatah and Hamas made some negotiations and could reach a reconciliation deal in 2011 but such deals could not overcome the mutual mistrust between the two Palestinian groups (Munayyer, 2011: 21). As a result, the context of the Arab Uprisings and the reconciliation negotiations of the two groups did not facilitate the goal of establishing *asabiyya* which would lead to a future Palestinian state.

#### **4. ANALYSES AND CONCLUDING REMARKS**

The Palestinian case should be considered a unique case because of some particular aspects in terms of domestic-international distinction. In the first place, Palestinians living in the territories have to face the consequences of the Israeli occupation in their daily lives. After long years of military struggle, Israel occupied most of the territories populated by Palestinians such as East Jerusalem and the West Bank. The Israeli administration can take decisions about the issues related to the territory and the people living on it and put these decisions into practice. The Israeli administration in the occupied territories was defined as “apartheid of a special type” due to its similarities with the former apartheid regime in South Africa (Greenstein, 2020: 82). In other words, Palestinians do not have an independent and sovereign state so they cannot control all the dynamics on the ground. In addition, the airspace and territorial waters of those territories are under the direct control of Israel and the Palestinian economy is dependent on the decisions of the Israeli administration as well as foreign aid. Therefore, there is no clear-cut distinction between domestic and international fields for the Palestinian case. Apart from that, the Israeli administration can control the mobility of Palestinians with the help of several checkpoints among different neighborhoods and the existence of illegal Israeli settlements. These difficult conditions and the reality of Israeli occupation on the ground lead to a two-fold impact on the possibilities of *asabiyya*: Whereas the Israeli occupation and its results on the daily activities of Palestinians block a collective movement or common initiatives, they certainly contribute to the emergence of solidarity and

collective consciousness against a common enemy and towards a common goal.

Establishing an independent and sovereign Palestinian state can be considered an important step among the demands of Palestinians. However, this kind of collective consciousness or solidarity cannot guarantee the emergence of *asabiyya* among Palestinians in the Ibn Khaldunian sense. According to Ibn Khaldun, *asabiyya* emerges naturally and cannot be imposed by a dominant authority. Each member has to adapt to this strong group solidarity without feeling enforced. Compared to the discontinuous parts of the West Bank, Gaza looks more unified after the Israeli disengagement and the Israeli blockade. The Western sanctions on Gaza make the Palestinians living in Gaza more alert due to direct external threats. In any case, domestic splits among Palestinians harden the possibility of reaching their goals like a future Palestinian state. Moreover, the Israeli-Palestinian conflict has many dimensions and complicated issues which directly or indirectly take attention from the regional or global actors. This multi-dimensional and complex nature of the Israeli-Palestinian conflict goes beyond the political will of both sides and requires a more comprehensive solution with the involvement of external actors. Because of the complex nature of the conflict, even a basic issue or a daily event related to Palestinians might be internationalized and evolved to a very different point. As a result, the Palestinian case is unique due to the ongoing Israeli occupation, the absence of a Palestinian state on the ground, and the complex nature of the Israeli-Palestinian conflict so the concept of *asabiyya* can be used as a tool for highlighting the peculiarities of the Palestinian context.

Ibn Khaldun's theory of change is based on the idea that rebellious change stems from structural problems due to weak leadership and the emergence of a rival group. To put it another way, a change in order results from both the weakening of dominant authority in a particular region and the rise of an alternative power base. Thus, social change emerges as a result of a dynamic process based on a struggle between the dominant power and the resistance movement. Ibn Khaldun explains the change in authority through "superiority coming from the spirit of the clan (*asabiyya*)" (Mozaffari and Vale, 1986/1987: 31). In the Palestinian context, the establishment of the Palestinian Authority under the leadership of Yasser Arafat as a part of the Oslo process created a window of opportunity for consolidating the PLO, or Fatah, power and establishing their order among Palestinians. The Fatah group was dominant and more advantageous compared to the other Palestinian groups. The possible achievements towards the settlement of the Israeli-Palestinian conflict or, at least, well-management of the process by the leaders of the Palestinian Authority and their practices towards

resolving some daily problems of the Palestinians would have kept their credibility high in the eyes of the Palestinian people. However, the failure of the Oslo process and widespread corruption in the administration of the Palestinian Authority changed the context to the detriment of the Fatah group. Furthermore, the replacement of leadership by Mahmoud Abbas after Arafat's death and its relatively low performance created another problem. For Hamas as an emerging power or a competitor, problems within the Fatah group and the suspension of the Oslo process contributed to favorable external conditions. Therefore, the strength of Hamas's challenge was a product of the failures and problems of the existing system in the region.

Apart from the failures and low performance of the Palestinian Authority, the Islamist moral and cultural order of Hamas was a significant alternative to the existing order among the Palestinian people and it could get the support of many Palestinians. The emotional appeal and sense of belonging for an Islamist alternative based on religious and cultural principles should be underlined in that sense. However, emotional appeal and religion-based ideology cannot be sufficient for a population living under the reality of occupation. It requires a certain amount of power and a strong political stance. Hamas offered not only an alternative cultural and moral order but also an alternative political and economic system that targeted the urgent needs and daily lives of the Palestinian people. Their long-term experience with social services compensated for their inexperience to rule in that sense.

The electoral victory of Hamas in the 2006 elections and its military takeover of Gaza in 2007 paved the way for Hamas to put its policies and ideas into practice. It provided opportunities as well as challenges for the Hamas leadership. Hamas used this opportunity to establish and consolidate its *asabiyya* in Gaza and could achieve its goal to a certain extent. The emergence of attempts for separate *asabiyyas* in two parts of the Palestinian groups triggered the debates around a three-state solution. Since Hamas offered an alternative cultural and moral order and it started a new process of identification among the Palestinians, Hamas's challenge went beyond political opposition in the elections. Therefore, Hamas control in Gaza became an important step for consolidating Hamas's *asabiyya* at least among a particular group of people. It is still early to talk about the emergence of two completely separate *asabiyyas* in the Palestinian society but it seems that the internal division among the Palestinians has deeper sources and it will remain one of the most crucial challenges for a possible Palestinian state. The results of the division will be better seen in the next period. In sum, some external reasons and Hamas achievements provided a favorable background for Hamas's *asabiyya* as a rival to the established



order of the Fatah group, and it strengthened the political division of the Palestinian groups which created more difficulties for the Palestinians in the international arena.

In conclusion, Ibn Khaldun's concept of *asabiyya* can be offered as a useful conceptual tool because of the peculiar aspects of the Middle Eastern context. The references to the concept of *asabiyya* go beyond group feeling or collective security so it includes meanings and components which can be used for the Palestinian case. Although the internal division of the Palestinian groups has blocked the emergence of a common and strong *asabiyya* among the Palestinians, Fatah and the Palestinian Authority in the West Bank and Hamas in Gaza aim to create their *asabiyyas* over the population under their control. The existence of domestic competition does not clash with the idea of *asabiyya*; on the contrary, the superior *asabiyya* generally comes out of a domestic struggle. For example, the Israeli state could be established as a result of struggles among the Zionist groups, the Labor Zionism and the Revisionist Zionists, in 1948 (Rynhold and Waxman, 2008: 14; Shlaim, 2012: 84). In other words, the State of Israel emerged as a result of a domestic struggle and the winning side could use the favorable political context to achieve its goals.

On the other hand, Fatah under the leadership of Arafat missed the opportunity in terms of uniting Palestinians toward the goal of a Palestinian state in the previous period. In the current context, the domestic split among the Palestinian groups does not facilitate achieving solidarity and unity among Palestinians and the establishment of a Palestinian state. A three-state solution or establishing their *asabiyyas* in the neighborhoods under their control can also be seen as another way of resolving the conflict but the realization of two independent and sovereign states does not seem realistic under the conditions on the ground. *Asabiyya* is the key factor for state and sovereignty, and its power comes from the unifying impact on members so domestic problems and splits neither lead to a strong *asabiyya* nor support to achieve common goals like a Palestinian state. Consequently, domestic struggles in Palestinian politics should end in strong *asabiyya* and unity that would provide energy for the Palestinian cause and the common goals of Palestinians; otherwise, they will not serve anything beyond consuming their energies.

### **Acknowledgment**

I would like to express my gratitude to my friend, Ersan Agbas, due to sharing his documents and information about Ibn Khaldun and his concept of *asabiyya*.



## REFERENCES

- Abozeid, A. (2021). Re-reading Ibn-Khaldun in the 21st Century: Traveling Theory and the Question of Authority, Legitimacy, and State Violence in the Modern Arab World. *Arab Studies Quarterly*, 43(2), 146–171.
- Ahmed, A. (2002). Ibn Khaldun's Understanding of Civilizations and the Dilemmas of Islam and the West Today. *Middle East Journal*, 56(1), 20–45.
- Ardic, N. (2012). Genealogy or Asabiyya? Ibn Khaldun between Arab Nationalism and the Ottoman Caliphate. *Journal of Near Eastern Studies*, 71(2), 315–324.
- Balpınar, Z. (2019). *İsrail Perspektifinden İki Devletli Çözüm*. Istanbul: Istanbul Bilgi Üniversitesi Yayınları.
- Ben-Ami, S. (2019). A Three-State Solution for Israel and Palestine? ASPI The Strategist, January 22. <https://www.aspistrategist.org.au/a-three-state-solution-for-israel-and-palestine/>, accessed June 12, 2019.
- Cherkaoui, M. D. (2012). *Asabiya: Hamas, Fatah, and the Power of Transformative Solidarity*. PhD thesis, George Mason University.
- Dabed, E. (2014). A Constitution for a Nonstate: The False Hopes of Palestinian Constitutionalism, 1988-2007. *Journal of Palestine Studies*, 43(2), 42–58.
- Dalacoura, K. (2012). Democracy as Counter-Terrorism in the Middle East: A Red Herring? *Uluslararası İlişkiler/ International Relations*, 8(32), 101–114.
- Danon, D. (2014). The Three-State Solution. Foreign Policy, June 2. <https://foreignpolicy.com/2014/06/02/the-three-state-solution-2/>, accessed June 12, 2019.
- Darling, L. T. (2007). Social Cohesion (“Asabiyya”) and Justice in the Late Medieval Middle East. *Comparative Studies in Society and History*, 49(2), 329–357.
- Ghazzal, M. (2005). Hamas Spokesman Muhammad Ghazzal, Remarks on the Disengagement, Hamas's Political Participation, and Require..., interview by Ian Douglas (al-Ahram Weekly, April 1, 2005), *Journal of Palestine Studies*, 34(4), 193–194.
- Golan, G. (2020). Obstacles and Possibilities for Peace between Israel and Palestine. *Insight Turkey*, 22(1), 33–46.
- Goldsmith, L. (2013). “God Wanted Diversity”: Alawite Pluralist Ideals and their Integration into Syrian Society 1832-1973. *British Journal of Middle Eastern Studies*, 40(4), 392–409.
- Greenstein, R. (2020). Israel, Palestine, and Apartheid. *Insight Turkey*, 22(1), 73–92.

- Hacohen, G. (2018). The Three-State Solution, BESA Center Perspectives Paper No. 870, June 19. <https://besacenter.org/perspectives-papers/three-state-solution/>, accessed July 21, 2019.
- Hinnebusch, R. (2014). The Arab Uprisings and The MENA Regional States System. *Uluslararası İlişkiler/ International Relations*, 11(42), 7–27.
- Hroub, K. (2006). A “New Hamas” through Its New Documents. *Journal of Palestine Studies*, 35(4), 6–27.
- Ibn Khaldun. (2004). *Mukaddime*, trans. H. Kendir. Istanbul: Yeni Safak.
- Irwin, R. (1997). Toynbee and Ibn Khaldun. *Middle Eastern Studies*, 33(3), 461–479.
- Kayapinar, M. A. (2008). Ibn Khaldun’s Concept of “Asabiyya”: An Alternative Tool for Understanding Long-Term Politics? *Asian Journal of Social Science*, 36(3/4), 375–407.
- Kimmerling, B. (2000). The Formation of Palestinian Collective Identities: The Ottoman and Mandatory Periods. *Middle Eastern Studies*, 36(2), 48–81.
- Klein, M. (2007). Hamas in Power. *Middle East Journal*, 61(3), 442–459.
- Lovlie, F. (2013). Explaining Hamas’s Changing Electoral Strategy, 1996–2006. *Government and Opposition*, 48(4), 570–593.
- Maisel, S. (2014). The New Rise of Tribalism in Saudi Arabia. *Nomadic Peoples*, 18(2), 100–122.
- Meric, C. (2006). *Umrandan Uygarlığa*, prep. M. A. Meric. Istanbul: İletişim Yayınları.
- Mozaffari, M. and Vale, M. (1986/ 1987). Authority in Islam. *International Journal of Politics*, 16(4), 1–127.
- Mufti, M. (2009). Jihad as Statecraft: Ibn Khaldun on the Conduct of War and Empire. *History of Political Thought*, 30(3), 385–410.
- Munayyer, Y. (2011). Prospects for Palestinian Unity After the Arab Spring. *Insight Turkey*, 13(3), 21–31.
- Muslih, M. (1993). Palestinian Civil Society. *Middle East Journal*, 47(2), 258–274.
- Putnam, R. D. (1988). Diplomacy and Domestic Politics: The Logic of Two-Level Games. *International Organization*, 42(3), 427–460.
- Rabbani, M. (2008). A Hamas Perspective on the Movement’s Evolving Role: An Interview with Khalid Mishal: Part II. *Journal of Palestine Studies*, 37(4), 59–81.
- Rosen, L. (2005). Theorizing from within: Ibn Khaldun and His Political Culture. *Contemporary Sociology*, 34(6), 596–599.
- Rynhold, J. and Waxman, D. (2008). Ideological Change and Israel’s Disengagement from Gaza. *Political Science Quarterly*, 123(1), 11–37.

- Sayigh, Y. (1989). Struggle within, Struggle without: The Transformation of PLO Politics Since 1982. *International Affairs*, 65(2), 247–271.
- Shemesh, M. (1984). The Founding of the PLO 1964. *Middle Eastern Studies*, 20(4), 105–141.
- Shlaim, A. (2012). The Iron Wall Revisited. *Journal of Palestine Studies*, 41(2), 80–98.
- Tomar, C. (2008). Between Myth and Reality: Approaches to Ibn Khaldun in the Arab World. *Asian Journal of Social Science*, 36(3/ 4), 590–611.
- Tschirgi, D. (2005-2006). The Middle East and Religious Fundamentalism as a Source of Identity-Based Conflicts. *Uluslararası İlişkiler/ International Relations*, 2(8), 151–165.
- Tuastad, D. (2010). The Role of International Clientelism in the National Factionalism of Palestine. *Third World Quarterly*, 31(5), 791–802.
- Volpi, F. (2004). Pseudo-Democracy in the Muslim World. *Third World Quarterly*, 25(6), 1061–1078.



“

## Chapter 8

### **AHP-TOPSIS INTEGRATED APPROACH IN USED CAR SELECTION AND AN APPLICATION**

*Hakan AYDOĞAN<sup>1</sup>*

*Fatma AKGÜN<sup>2</sup>*

”

---

1 Arş. Gör. Hakan AYDOĞAN, Bartın Üniversitesi, İktisadi ve İdari Bilimler Fakültesi/Yönetim Bilişim Sistemleri ABD, haydogan@bartin.edu.tr, OrcID: 0000-0002-0571-8535

2 Arş. Gör. Fatma AKGÜN, Bartın Üniversitesi, İktisadi ve İdari Bilimler Fakültesi/Yönetim Bilişim Sistemleri ABD, fakgun@bartin.edu.tr, OrcID: 0000-0002-2756-7870

## 1. Introduction

The transportation problem is a problem as old as the existence of humanity. With the developing technologies, human beings have used all possibilities to facilitate and accelerate transportation. Today, highways are frequently used for inter-city transportation, especially within the city. Different transportation vehicles are produced and used according to different needs.

Covid 19 pandemic, which started to affect the whole world towards the end of 2019, stagnation has occurred in almost every industry. The crises due to this recession started to be felt especially after the middle of 2021 and also affected the automobile markets. Due to the rapidly increasing automobile prices and the market insufficiency, it is seen that the people who will buy a vehicle have difficulty in making decisions. The aim of this case is to illustrate an approach that can find a solution to this problem. Because today's automobile industry offers a wide variety of brands and models to consumers. There are significant differences between brands and models in terms of physical equipment and shape. The features that consumers look for in a car are also very diverse. In such an periphery where there are many options and criteria, users have difficulty in making a decision while purchasing a car (Güngör and İşler, 2005).

This study deals with the selection of used cars as a multi-criteria decision-making problem. As a method, Analytical Hierarchy Process (AHP) and Rank Preference Technique according to Ideal Solution Similarity (TOPSIS) methodologies were integrated. It has been monitored in articles in the literature that these two methods yield successful results. It is seen that they are successful individually as well as achieving strong and reliable results together. The data of the case were acquired from 3 decision makers who are experts in their majorities and through sahibinden.com website. The selection criteria of this study; price, fuel consumption, safety, mileage, engine power, model year, engine displacement and design. Car alternatives are; It is designated as Audi A3, BMW 320d, Fiat Egea , Ford Focus , Renault Clio, Opel Astra, Volkswagen Passat and Volvo S60. In order to give a more consistent result of the study, the cars determined were selected from the vehicles produced between 2010 and 2017 between 100,000 and 200,000 KM.

In the following parts of this study, firstly, publications related to automobile selection in the literature, and publications related to AHP and TOPSIS methods are included in the literature review section. Then,

the definition and development of AHP and TOPSIS are given in the method part. In this section, the application steps of the AHP and TOPSIS methods are clearly shown. Finally, the use of the methods was demonstrated with a numerical application and an evaluation was made in the conclusion part.

## **2. Literature Review**

Byun (2001) investigated the decision to buy a car using the AHP method by making a two-stage selection using 3 car models.

Güngör and İşler (2005) proposed a solution for automobile selection with AHP in their study. In addition to the objective values, subjective values for the consumer were also taken into account.

Supçiler and Cross (2011), the problem of supplier selection was discussed. In the study, the main criteria and the degree of noteworthiness of the sub-criteria were identified by the AHP method. Then, supplier rankings were made with TOPSIS.

Apak, Göğüş, and Karakadılar (2012) investigated luxury automobile consumer preferences using AHP in their study. In this evaluation procedure, they used the AHP method to determine the concern weight of the criterion.

Yavuz (2012) aimed to find the factors that affect teachers' car choices in his study. It specified the criteria and alternatives. Using the AHP method, the factors affecting the car preferences of the teachers were determined by making pairwise comparisons.

In their study, Karahan and Dinç (2015) aimed to choose the appropriate car with AHP. It focused to determine the momentousness criteria that will help the purchase of a car by including the information of 120 random automotive users in a local automotive company in Diyarbakır and the regional conditions on the car buyers.

In their study, Yavaş et al., (2015) examined the vehicle selection approaches of customers and determined the criteria that led to their purchase. They used AHP and ANP methods as methods.

Aytekin (2017) tried to increase the productivity of academics in his study. He developed a software in Delphi language to evaluate the performance of academic staff. It also used AHP in the rating system.

Yerlikaya and Arıkan, (2017) discussed sustainable supply chain management in their studies. In this study, they used AHP and critical

TOPSIS methods for supplier selection under the sustainability framework.

Sonar and Kulkarni (2018) aim to present an integrated hybrid of AHP and multi-attribute boundary approach area comparison (MABAC) method for choosing the best alternative for electric vehicle selection and ranking as a result of these selections.

Ulkhayq et al. (2018) aimed to evaluate automobile selection using AHP and TOPSIS in their article. The weights of the criteria were specified by AHP, and the TOPSIS method was used to choose the best alternative in the determined weights.

Astantia, Mbolla and Jin Ai (2020) used AHP and fuzzy AHP methods jointly for the election of raw material suppliers in glove production. The results were defended by statistical methods.

Gavcar and Kara (2020) aimed to compare and rank 11 different electric cars according to certain criteria. The significance levels of the criteria were tried to be identified by using the Entropy technique. The data obtained from this method were also analyzed with TOPSIS and automobile rankings were made.

Hasnain et al. In the (2020) studies, soda ash industry experts are consulted to prioritize the parameters that affect the boiler selection. The problem is highlighted with AHP and then the TOPSIS technique is used.

Ceylan and Gürsev (2020), it is aimed to list the general features and criteria of the project by developing 4 different software over project management techniques such as Scrum, Kanban and Waterfall, which are included in the different functions of the mobile bank application operating in Turkey. The weights of the criteria were specified with AHP, and their successes were listed with TOPSIS.

Aytekin, Akgün, and Aydoğan (2021) used AHP and fuzzy AHP techniques in their study to evaluate the criteria for university students' mobile phone selection and rank the alternatives.

Bathrinath, Bhalaji and Saravanasankar (2021), in their work, is to recognize and examine the accidents and risks in the textile industry using AHP and TOPSIS.

Çelik and Aydoğan (2021), in their study, aimed to find the most appropriate hotel among the 8 best 5-star hotels in the Taksim region of Istanbul using the TOPSIS method.



Ergül and Çokyaşar (2021), in their study, aimed to help people choose cars according to the criteria that everyone considers important while choosing cars. TOPSIS technique was used in this article.

Petroutsatou, Ladopoulos, and Nalmpantis (2021) aimed to Hierarchize the Criteria of the Construction Equipment Procurement Decision Using the AHP Method in their study. They conducted scientometric analysis of the last 25 years with AHP to investigate its use in the thematic field. A model based on AHP was developed to determine the purchasing criteria of the equipment.

Abdulvahitoğlu and Kılıç (2022) used AHP to appraise the significance of each criteria and TOPSIS to calculate alternatives for these investigated values. They said that the analysis method they used can be used as a pre-investment tool to reduce exhaust emissions and dependence on fossil fuels.

Mojaver et al. (2022), it is aimed to prioritize the criteria for order performance with AHP and to select the best raw material for gasification, similar to the ideal solution-related method used in the gasification of traditional biomass and plastic wastes.

Rajput, Sahu, and Agrawal (2022) used multi-criteria decision-making techniques for material choosing in the manufacturing industry. AHP and TOPSIS methods were used in a hybrid structure to rank the kota stone powder filled epoxy composites.

### **3. Method**

In this study, two different multi-criteria decision-making methods were used together for the selection of second-hand cars. Inter-criteria evaluation was made with the AHP method, and the alternatives were ranked according to the criteria weights with the TOPSIS method. In the literature, these two multi-criteria decision-making methods are frequently used together, and it is stated that better results are obtained. For this reason, in the method part of the study, the details of the AHP and TOPSIS methods will be mentioned, and the problem will be solved in practice.

#### **3.1. AHP Method**

Multi-criteria decision making provides a set of procedures and techniques for solving complex decision-making problems in a hierarchical manner. AHP is one of the most common MCDM methods

used for site selection (Saaty, 1977, 1990). The process makes it possible to combine judgments about abstract qualitative criteria as well as concrete quantitative criteria (Amiri, 2010).

Saaty (1980), AHP deals with how to determine the relative importance of a set of activities in a multi-criteria decision problem. The AHP method has been used as a MCDM tool that provides a systematic comparison of alternatives and can be applied to almost all areas of decision making (Cruz- Cunha et al., 2016). The AHP method is based on three principles: first, the structure of the model; second, comparative judgment of alternatives and criteria; third, synthesis of priorities (Dağdeviren, 2008).

AHP presents the concept of hierarchy while addressing problems with a set of criteria and alternatives (Han et al., 2020). In addition to individual decision making, AHP also supports group decision making by group members in defining the problem using their knowledge, experience, and predictions, categorizing them into hierarchies, and solving them using the AHP steps. Aggregation of an individual priority vector into a group vector can be accomplished using numerous methods described in the literature (Draginčić and Vranešević, 2014). AHP allows decision makers to structure complex problems hierarchically or as a series of integrated levels with a certain number of levels from root (target) to leaves (alternatives) (Chan and Chan, 2010). This hierarchical structure is shown in Figure 1 below.

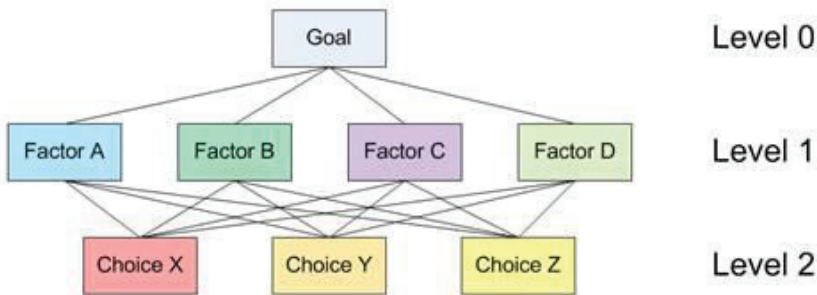

Figure 1: Representation of the AHP Hierarchy

Saaty for pairwise comparisons and its explanation are shown in Table 1.

Table 1: Saaty's 1-9 point scale and explanation

Explanation	Importance level
Equally Important	1
Moderately Important	3
Quite Important	5
Very important	7
Extremely Important	9
Intermediate Values	2,4,6,8

Saaty (1980) are given below, respectively:

**Step 1:** A decision matrix is created for each decision maker with the data received from the decision makers (1).

$$D_k = \begin{bmatrix} x_{11} & \dots & x_{1n} \\ \vdots & \ddots & \vdots \\ x_{m1} & \dots & x_{mn} \end{bmatrix} \tag{1}$$

**Step 2:** The geometric mean is found for each element from the k number of decision matrices obtained (2).

$$X_{mn} = \sqrt[k]{X_{mn}^{(1)} * X_{mn}^{(2)} * \dots * X_{mn}^{(k)}} \tag{2}$$

**Step 3:** Based on the geometric mean result, the initial decision matrix is created (3).

$$D = \begin{bmatrix} x_{11} & \dots & x_{1n} \\ \vdots & \ddots & \vdots \\ x_{m1} & \dots & x_{mn} \end{bmatrix} \tag{3}$$

**Step 4:** After the decision matrix is created, the decision matrix normalized with (4) is created.

$$r_{ij} = \frac{x_{ij}}{\sqrt{\sum_{m=1}^n x_{mj}^2}} \tag{4}$$

**Step 5:** The weight values are found by taking the average of each row of the normalized decision matrix (5).

$$X_m = (X_1 + X_2 + \dots + X_n)/n \tag{5}$$

**Step 6:** A consistency test is performed to check the consistency of the weighted values. For the consistency test, firstly, the initial decision matrix and the weight values are multiplied (6) and the result is divided by the weight values (7).

$$D = \begin{bmatrix} x_{11} & \cdots & x_{1n} \\ \vdots & \ddots & \vdots \\ x_{m1} & \cdots & x_{mn} \end{bmatrix} * \begin{bmatrix} W_1 \\ \dots \\ W_m \end{bmatrix} = \begin{matrix} Z_1 \\ \dots \\ Z_m \end{matrix} \quad (6)$$

$$T_m = Z_m/W_m \quad (7)$$

**Step 7:** The  $\lambda_{\max}$  value is calculated (8). The CI value is calculated (9). The RI value is found from the table, Table 1 shows the RI values. The CR value is calculated (10). If  $CR < 0,1$  it is considered consistent (Saaty, 1980).

$$\lambda_{maks} = (Z_1 + Z_2 + \cdots + Z_m)/m \quad (8)$$

$$CI = (\lambda_{maks} - m)/m - 1 \quad (9)$$

$$CR = CI/RI \quad (10)$$

Table 1: RI Values

Number of Criteria	RI Value
one	0
2	0
3	0.52
4	0.89
5	1.11
6	1.25
7	1.35
8	1.40
9	1.45
10	1.49

### 3.2. TOPSIS Method

TOPSIS is a MCDM method most frequently used by decision makers to find a solution to a complex problem due to its simplicity and ease, with conflicting criteria in various fields such as supplier selection, health, transportation route selection (Tiwari and Kumar, 2021). The Rank Preference Technique (TOPSIS) by Similarity to Ideal Solution, developed by Hwang and Yoon (1981), is based on the concept of positive ideal solution (PIS) and negative ideal solution (NIS). TOPSIS is

a type of statistical analytical method. It can determine the order preference of the evaluation objects through Ideal Solution and Negative Ideal Solution (Wu & Yang, 2008). TOPSIS is a MCDM technique and is based on the idea that the highest order access network should have the longest geometric distance from the negative ideal solution and the shortest geometric distance from the positive ideal solution. Based on the weights assigned to each criterion, this technique normalizes them and finds the geometric distance between each alternative access network and the ideal alternative (Gupta, 2016). In summary, the positive-ideal solution consists of all the best achievable values of the criteria, and the negative-ideal solution consists of all the worst achievable values of the criteria (Krohling and Pacheco, 2015). According to this method, decision matrices are created by determining m number of alternatives and n number of criteria. Then, the best positive and negative ideal solutions are found, and the most appropriate solution is reached (Çelik and Aydoğan, 2021).

Rank Preference Technique (TOPSIS) by Similarity to Ideal Solution, developed by Hwang and Yoon (1981), are given below, respectively:

**Step 1:** The alternatives are scored according to the criteria (11).

$$A = \begin{bmatrix} x_{11} & \cdots & x_{1n} \\ \vdots & \ddots & \vdots \\ x_{m1} & \cdots & x_{mn} \end{bmatrix} \quad (11)$$

**Step 2:** After the alternative matrix is created, the normalization matrix is created (12).

$$r_{ij} = \frac{x_{ij}}{\sqrt{\sum_{m=1}^n x_{mj}^2}} \quad (12)$$

**Step 3:** The weighted matrix is created by multiplying the normalized matrix weight values (13).

$$W_{mn} = w_m * N_{mn} \quad (13)$$

**Step 4:** The positive ideal solution and the negative ideal solution are found with (14) and (15) in the weighted matrix.

$$A^+ = \{(\max_i v_{ij} \mid j \in J), \{(\min_i v_{ij} \mid j \in J')\} \quad (14)$$

$$A^- = \{(\min_i v_{ij} \mid j \in J), \{(\max_i v_{ij} \mid j \in J')\} \quad (15)$$

**Step 5:** The distance to the positive and negative ideal solutions is found by (16) and (17)

$$S_j^+ = \sqrt{\sum_{j=1}^n (v_{ij} - v_j^*)^2} \tag{16}$$

$$S_j^- = \sqrt{\sum_{j=1}^n (v_{ij} - v_j^-)^2} \tag{17}$$

**Step 6:** Alternatives are ranked by calculating the relative closeness for each alternative (18).

$$C_i^* = \frac{S_j^-}{S_i^- + S_i^*} \quad 0 \leq C_i^* \leq 1 \tag{18}$$

#### 4. Application

##### 4.1. Scope, Purpose and Importance of the Study

The aim of this study is to select the most suitable car among certain criteria and alternatives in the purchase of second-hand cars. Especially due to the Covid-19 pandemic and the crisis of new vehicle production, the buying and selling of second-hand cars has become a very serious business in our country. It has become very important for both sellers and buyers to evaluate the most suitable options. This application is about the evaluation of 8 alternatives according to 8 criteria. AHP-TOPSIS integrated method was used to perform the decision-making application and to rank the alternatives. In order to make comparisons, the most frequently viewed criteria in the purchase of used cars are listed in Table 2 below.

Table 2: Criteria and explanations

CRITERIA	EXPLANATION
Price	Used price of the car to be purchased
Fuel consumption	Average energy consumption of the vehicle to be purchased
Security*	Number of safety-related functions of the vehicle to be purchased
KM	KM counter value of the used car to be purchased
Motor power	Horsepower of the engine of the vehicle to be purchased
Model year	Production year of the vehicle to be purchased
Engine capacity	The sum of the fuel and air mixture delivered in the engine of the vehicle to be purchased
Design**	Number of interior and exterior equipment features of the vehicle to be purchased

\*The number of functions in the security area on the website is taken into account.

\*\*The number of internal and external equipment on the website is taken into account.

Within the scope of this study, the best-selling models of the brands determined with the help of experts in the used car market were determined on sahibinden.com. The cars and their features, which are determined in Table 3 below, are shown as alternatives to this study.

Table 3: Cars designated as alternatives

ALTERNATIVES	Price (₺)	KM*	Model**
Audi A3	375,000	113,000	2012
BMW 320d	437,500	195,000	2014
Fiat Egea	218,000	151,000	2016
Ford Focus	299,500	164,000	2015
Renault Clio	199,500	165,000	2017
Opel Astra	210,000	190,000	2013
Volkswagen Passat	315,000	164,000	2010
Volvo S60	330,000	162,000	2011

\*Alternatives are selected from 100,000 – 200,000 KM.

\*\*Alternatives are selected from 2010 – 2017 Model vehicles.

## 4.2. Data Collection

In this study, 3 decision makers who are experts in the used car market were used. Expert decision makers have formed 8 criteria in agreement about which features the customers give the most importance to in the purchase of second-hand cars. The decision makers then determined 8 different car brands to appeal to the lower, middle and upper classes. Alternatives were created by finding the best-selling models in the second-hand car section of the sahibinden.com website for the specified car brands. In comparison of the alternatives according to the criteria, the car features on this website were evaluated by the decision makers.

## 4.3. Evaluation of Research Findings

**Step 1:** AHP management is used to compare criteria. It is defined between 1-8 for easy display of the criteria determined by the decision makers in the tables. C1: Price, C2: Fuel Consumption, C3: Safety, C4: KM, C5: Engine Power, C6: Model Year, C7: Engine Displacement, C8:

Design. The criteria determined by expert decision makers are evaluated according to Saaty's 1-9 scale. Then, Table 5 is formed by taking the geometric mean of the pairwise comparison value of each decision maker.

Table 5: Comparison of Criteria

	C1	C2	C3	C4	C5	C6	C7	C8
C1	1,000	1,817	1,817	2,884	5,944	3,107	5,944	7,368
C2	0.550	1,000	0.437	1,817	3,634	3,107	4,481	9,283
C3	0.550	2,289	1,000	3,302	6,542	3,915	6,316	7,830
C4	0.347	0.550	0.303	1,000	3,557	0.874	4,217	4,481
C5	0.168	0.275	0.153	0.281	1,000	0.281	2,289	0.500
C6	0.322	0.322	0.255	1,145	3,557	1,000	3,557	2,884
C7	0.168	0.223	0.158	0.237	0.437	0.281	1,000	0.630
C8	0.136	0.108	0.128	0.223	2,000	0.347	1,587	1,000

**Step 2:** By normalizing the matrix of the comparison of the criteria, the normalized criterion comparison matrix is obtained. Normalized criteria comparisons are shown in Table 6.

Table 6: Normalized Criteria Comparisons

	C1	C2	C3	C4	C5	C6	C7	C8
C1	0.309	0.276	0.427	0.265	0.223	0.241	0.202	0.217
C2	0.170	0.152	0.103	0.167	0.136	0.241	0.152	0.273
C3	0.170	0.348	0.235	0.303	0.245	0.303	0.215	0.230
C4	0.107	0.084	0.071	0.092	0.133	0.068	0.143	0.132
C5	0.052	0.042	0.036	0.026	0.037	0.022	0.078	0.015
C6	0.099	0.049	0.060	0.105	0.133	0.077	0.121	0.085
C7	0.052	0.034	0.037	0.022	0.016	0.022	0.034	0.019
C8	0.042	0.016	0.030	0.020	0.075	0.027	0.054	0.029

**Step 3:** Weight values are found from normalized criterion comparisons. The weights of the criteria are shown in Table 7.

Table 7: Weight Values of Criteria

Criteria	C1	C2	C3	C4	C5	C6	C7	C8
Weights	0.270	0.174	0.256	0.104	0.038	0.091	0.029	0.037

**Step 4:** After the weighting, the CR value is found to test the consistency of the model. Since there are 8 criteria in this model, the RI value was found from the table and taken as 1.40. The CR value of the model is consistent as  $0.044 < 0.1$  according to the calculations. The consistency test of the model is shown in Table 8.



Table 8:  $\lambda$ , CI, RI and CR Values

$\lambda$	CI	RI	CR
8,434	0.062	1,410	0.044

**Step 5:** TOPSIS method is used to evaluate the alternatives. Information from expert decision makers and sahibinden.com data were used to create the decision matrix. It is defined between 1-8 in order to show the determined alternatives easily in the tables. A1: Audi A3, A2: BMW 320d, A3: Fiat Egea, A4: Ford Focus, A5: Reanult Clio, A6: Opel Astra, A7: Volkswagen Passat, A8: Volvo S60. Each decision maker evaluated each alternative on a scale of 1-10 for all criteria, and Table 9 was formed by taking the geometric mean of these values.

Table 9: Decision Matrix

	C1	C2	C3	C4	C5	C6	C7	C8
A1	2,621	8,243	8,000	6,649	6,316	4,309	6,604	8,653
A2	1,587	4,932	5,646	1,000	8,320	5,944	9,655	6,952
A3	6,649	4,932	5,646	5,313	5,000	6,952	3,915	4,642
A4	5,313	6,952	5,646	3,302	6,316	6,649	6,604	5,944
A5	7,652	7,230	9,322	3,302	2,621	7,652	7,319	6,952
A6	6,649	3,915	3,302	2,000	6,316	5,313	8,320	5,944
A7	3,915	3,420	6,649	3,302	7,319	2,884	5,593	7,958
A8	3,634	5,944	7,000	4,309	9,322	3,915	9,655	9,322

**Step 5:** Normalized decision matrix is created. After the decision matrix was created, the matrix was normalized with the formula (12). The normalized decision matrix is shown in Table 10.

Table 10: Normalized Decision Matrix

	C1	C2	C3	C4	C5	C6	C7	C8
A1	0.180	0.493	0.427	0.586	0.332	0.269	0.452	0.518
A2	0.109	0.295	0.302	0.088	0.438	0.371	0.661	0.416
A3	0.455	0.295	0.302	0.468	0.263	0.434	0.268	0.278
A4	0.364	0.416	0.302	0.291	0.332	0.415	0.452	0.355
A5	0.524	0.432	0.498	0.291	0.138	0.477	0.501	0.416
A6	0.455	0.234	0.176	0.176	0.332	0.332	0.570	0.35
A7	0.268	0.205	0.355	0.291	0.385	0.180	0.383	0.476
A8	0.249	0.355	0.374	0.380	0.490	0.244	0.661	0.558

**Step 6:** Weighted decision matrix is created. The weights determined in Table 7 for the criteria are multiplied by each element of

the normalized decision matrix in Table 10 to form a weighted decision matrix. The weighted decision matrix is given in Table 11.

Table 11: Weighted Decision Matrix

	C1	C2	C3	C4	C5	C6	C7	C8
A1	0.048	0.086	0.074	0.061	0.013	0.025	0.122	0.090
A2	0.029	0.051	0.053	0.009	0.017	0.034	0.179	0.072
A3	0.123	0.051	0.053	0.049	0.010	0.040	0.072	0.048
A4	0.098	0.072	0.053	0.030	0.013	0.038	0.122	0.062
A5	0.141	0.075	0.087	0.030	0.005	0.044	0.135	0.072
A6	0.123	0.041	0.031	0.018	0.013	0.030	0.154	0.062
A7	0.072	0.036	0.062	0.030	0.015	0.016	0.103	0.083
A8	0.067	0.062	0.065	0.039	0.019	0.022	0.179	0.097

**Step 7:** Constructing positive ideal ( $A^+$ ) and negative ideal ( $A^-$ ) solutions. Positive ideal solutions represent the best performance values, and negative ideal solutions represent the worst performance results. Positive and negative ideal solutions are shown in Table 12.

Table 12: Positive and Negative Ideal Solutions

	C1	C2	C3	C4	C5	C6	C7	C8
Positive ( $A^+$ )	0.141	0.086	0.087	0.061	0.019	0.044	0.179	0.097
Negative ( $A^-$ )	0.029	0.036	0.031	0.009	0.005	0.016	0.072	0.048

**Step 6:** The distance of the weighted values from the positive ideal solutions ( $S^+$ ) and the distance from the negative ideal solutions ( $S^-$ ) were calculated. The results are shown in Table 13.

Table 13: Discrimination Measurements

	$S^+$	$S^-$
A1	0.098	0.138
A2	0.139	0.157
A3	0.096	0.117
A4	0.072	0.130
A5	0.038	0.176
A6	0.091	0.159
A7	0.105	0.105
A8	0.095	0.175

**Step 8:** The closeness to the ideal solution was calculated according to the formula (18) and sorted. Ranking is shown in Table 14.

Table 14: Car Ranking

<b>Desk</b>	<b>Car</b>	<b>Result (C*)</b>
<b>one</b>	Renault Clio	0.822
<b>2</b>	Volvo S60	0.648
<b>3</b>	Ford Focus	0.643
<b>4</b>	Opel Astra	0.636
<b>5</b>	Audi A3	0.586
<b>6</b>	Fiat Egea	0.550
<b>7</b>	BMW 320d	0.531
<b>8</b>	Volkswagen Passat	0.500

## 5. Conclusion

In this study, the second-hand car market, which has started to attract excessive attention in recent years due to the Covid 19 pandemic and new vehicle production problems, has been examined. It is a difficult decision-making process for the buyer to choose the most suitable vehicle for their needs, especially the increasing prices. Decision-making in car selection and ordering of alternatives can be explained by multi-criteria decision-making algorithms. For this reason, the solution of the problem is provided by using the Analytical Hierarchy Process (AHP), which are the most widely used methods in decision making in the literature, and the Rank Preference Technique according to the Ideal Solution Similarity (TOPSIS) integrated. It has been mentioned in the studies given in the literature review that the AHP method is superior in weighting and ranking among the criteria. It also demonstrates how valid the results are in practice by performing a consistency analysis. As the TOPSIS method deals with the ideal solution with a geometric structure, it reveals how close and how far the alternatives are from the ideal solution. A stronger and more reliable result was obtained by using the AHP method for weighting the criteria and the TOPSIS method for ranking the alternatives.

The data of the study were obtained from the website sahibinden.com in March 2022 with expert decision makers. In this study, 3 decision makers determined the 8 most important criteria when buying a used car as price, fuel consumption, safety, KM, engine power, model year, engine volume and design. Then, they determined 8 different automobile brands belonging to the lower, middle and upper segments

and determined the best-selling models of these brands. These cars are Audi A3, BMW 320d, Fiat Egea, Ford Focus, Renault Clio, Opel Astra, Volkswagen Passat and Volvo S60. The cars used in the study were selected from the vehicles produced between 2010 and 2017 with a range of between 100,000 and 200,000 km. After the decision makers determined the criteria according to the 1-9 Saaty scale with pairwise comparison matrices among themselves, the decision matrix was formed by taking the geometric mean. Likewise, they scored the evaluation of the vehicles according to the criteria on a 1-10 scale and a decision matrix was formed with the geometric mean. The weights and ranking of the criteria by expert decision makers are shown in Figure 2 below.

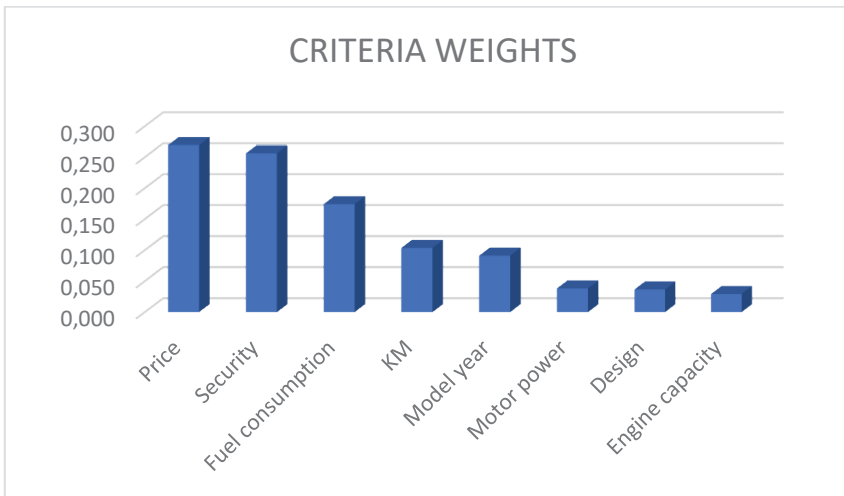

Figure 2: Criteria Weights

As shown in Figure 2, the most important criterion for buyers is price, followed by safety, fuel consumption, KM, model, engine power, design and engine volume. As a result of the application, the ranking of the cars determined by the weights of the above criteria is shown in Figure 3.

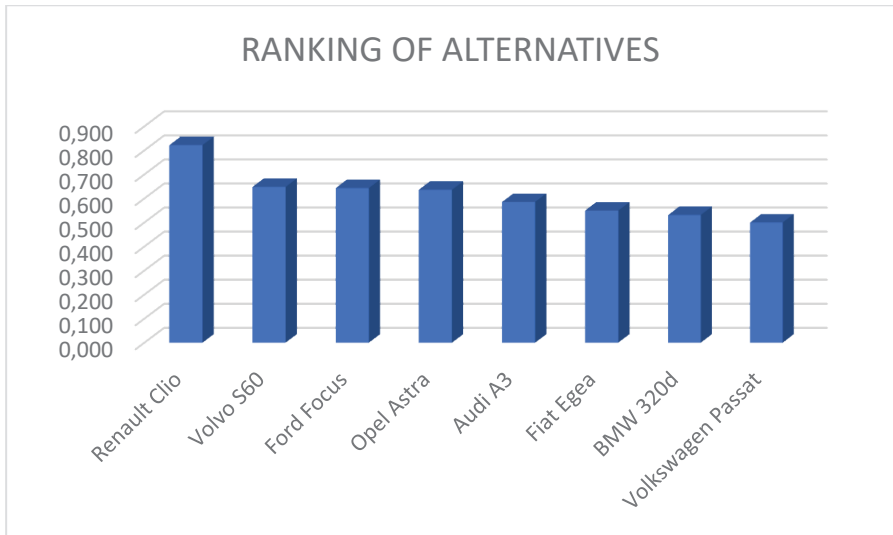

Figure 3: Ranking of Alternatives

As shown in Figure 3, it is seen that the most suitable choice among the alternatives determined is Renault Clio, followed by Volvo S60, Ford Focus, Opel Astra, Audi A3, Fiat Egea, BMW 320d and Volkswagen Passat.

While obtaining the data in this study, the digitization of all data created limitations in certain criteria of the study. The security constraint has been digitized by looking at how many security-related functions it has in the section on sahibinden.com. Likewise, for the design constraint, it has been digitized by looking at how many functions it has for interior and exterior hardware on sahibinden.com.

To take this work further, the fuzzy method of the same method can be used to remove the constraints. It can be observed how much decision making in a fuzzy environment changes the results, and the differences can be discussed by revealing them.

## REFERENCES

- Abdulvahitoglu, A., & Kilic, M. (2022). A new approach for selecting the most suitable oilseed for biodiesel production; the integrated AHP-TOPSIS method. *Ain Shams Engineering Journal*, 13(3), 101604.
- Amiri, M. P. (2010). Project selection for oil-fields development by using the AHP and fuzzy TOPSIS methods. *Expert systems with applications*, 37(9), 6218-6224.
- Apak, S., Göğüş, G. G., & Karakadılar, İ. S. (2012). An analytic hierarchy process approach with a novel framework for luxury car selection. *Procedia-Social and Behavioral Sciences*, 58, 1301-1308.
- Astanti, R., Mbolla, S., & Ai, T. (2020). Raw material supplier selection in a glove manufacturing: Application of AHP and fuzzy AHP. *Decision Science Letters*, 9(3), 291-312.
- Aytekin, A. (2017). Academic staff performance evaluation by AHP (analytic hierarchy process) and software package preparation. *International Journal of Advanced Engineering and Management Research*, 2(4), 1127-1147.
- Aytekin, A., Akgün, F. & Aydoğan, H. (2021). Bartın Üniversitesi Yönetim Bilişim Sistemleri Öğrencilerinin Cep Telefonu Seçiminin Analitik Hiyerarşik Süreç ve Bulanık Analitik Hiyerarşik Süreç Yöntemleri Kullanılarak Belirlenmesi. Tekmez Kulu, Hamza Kahriman (Ed.), *Bireyden Yapay Zekaya Sosyoekonomik ve Kültürel Çalışmalar* içinde (s. 1-25). Ankara: Akademisyen Kitabevi.
- Bathrinath, S., Bhalaji, R. K. A., & Saravanasankar, S. (2021). Risk analysis in textile industries using AHP-TOPSIS. *Materials Today: Proceedings*, 45, 1257-1263.
- Byun, D. H. (2001). The AHP approach for selecting an automobile purchase model. *Information & management*, 38(5), 289-297.
- Chan, F. T., & Chan, H. K. (2010). An AHP model for selection of suppliers in the fast changing fashion market. *The International Journal of Advanced Manufacturing Technology*, 51(9), 1195-1207.
- CEYLAN, Z., & GÜRSEV, S. (2020). AHP ve TOPSIS Yöntemleri ile Bilgi Teknolojileri Projelerinde Scrum-Kanban-Şelale Uygulamaları Karşılaştırması. *Bilişim Teknolojileri Dergisi*, 13(3), 329-339.
- Cruz-Cunha, M. M., Silva, J. P., Gonçaves, J. J., Fernandes, J. A., & Ávila, P. S. (2021). ERP selection using an AHP-based decision support system. In *Research Anthology on Recent Trends, Tools, and Implications of Computer Programming* (pp. 374-391). IGI Global.

- ÇELİK, K., & AYDOĞAN, H. TOPSİS TABANLI KARAR VERME YAKLAŞIMI: İSTANBUL'DA BİR UYGULAMA. *Bilgi ve İletişim Teknolojileri Dergisi*, 3(2), 158-174.
- Dağdeviren, M. (2008). Decision making in equipment selection: an integrated approach with AHP and PROMETHEE. *Journal of intelligent manufacturing*, 19(4), 397-406.
- Draginčić, J., & Vranešević, M. (2014). AHP-based group decision making approach to supplier selection of irrigation equipment. *Water resources*, 41(6), 782-791.
- ERGÜL, S. G., & Çokyavaş, A. (2021). Otomobil Seçimi İçin TOPSIS Temelli Bir Karar Verme Yaklaşımı. *Avrupa Bilim ve Teknoloji Dergisi*, (31), 713-724.
- Gavcar, E., & Nusret, K. A. R. A. (2020). Elektrikli Otomobil Seçiminde Entropi ve TOPSIS Yöntemlerinin Uygulanması. *İş ve İnsan Dergisi*, 7(2), 351-359.
- Gupta, V. (2016, December). Network selection in 3G-WLAN interworking environment using TOPSIS. In *2016 11th International Conference on Industrial and Information Systems (ICIIS)* (pp. 512-517). IEEE.
- Güngör, İ., & İşler, D. B. (2004). Analitik Hiyerarşi Yaklaşımı İle Otomobil Seçimi. *Uluslararası Yönetim İktisat ve İşletme Dergisi*, 1(2), 21-33.
- Han, Y., Wang, Z., Lu, X., & Hu, B. (2020). Application of AHP to road selection. *ISPRS International Journal of Geo-Information*, 9(2), 86.
- Hasnain, S., Ali, M. K., Akhter, J., Ahmed, B., & Abbas, N. (2020). Selection of an industrial boiler for a soda-ash production plant using analytical hierarchy process and TOPSIS approaches. *Case Studies in Thermal Engineering*, 19, 100636.
- Hwang, C. & Yoon, K. (1981). Methods For Multiple Attribute Decision Making in Multiple Attribute Decision Making. *Lecture Notes in Economics and Mathematical Systems*, 86.
- KARAHAN, M., & Dinç, H. (2015). ANALİTİK HİYERARŞİ SÜRECİ YAKLAŞIMI İLE BÖLGESEL TERCİHLERE UYGUN OTOMOBİL SEÇİMİ.
- Krohling, R. A., & Pacheco, A. G. (2015). A-TOPSIS—an approach based on TOPSIS for ranking evolutionary algorithms. *Procedia Computer Science*, 55, 308-317.
- Mojaver, M., Hasanzadeh, R., Azdast, T., & Park, C. B. (2022). Comparative study on air gasification of plastic waste and conventional biomass based

on coupling of AHP/TOPSIS multi-criteria decision analysis. *Chemosphere*, 286, 131867.

Petroutsatou, K., Ladopoulos, I., & Nalmpantis, D. (2021). Hierarchizing the Criteria of Construction Equipment Procurement Decision Using the AHP Method. *IEEE Transactions on Engineering Management*.

Rajput, V., Sahu, N. K., & Agrawal, A. (2022). Integrated AHP-TOPSIS methods for optimization of epoxy composite filled with Kota stone dust. *Materials Today: Proceedings*, 50, 2371-2375.

Saaty, T. (1977). A Scaling Method For Priorities in Hierarchical Structures. *Journal of Mathematical Psychology*, 15, 234-281.

Saaty, T. (1980). Multicriteria Decision Making: The Analytic Hierarchy Process. *McGraw-Hill*, New York.

Saaty, T. (1990). How To Make a Decision: The Analytic Hierarchy Process. *European Journal of Operational Research*, 48, 9-26.

Sonar, H. C., & Kulkarni, S. D. (2021). An integrated ahp-mabac approach for electric vehicle selection. *Research in Transportation Business & Management*, 41, 100665.

Supçiller, A., & Çapraz, O. (2011). AHP-TOPSIS yöntemine dayali tedarikçi seçimi uygulaması. *Istanbul University Econometrics and Statistics e-Journal*, (13), 1-22.

Tiwari, R. K., & Kumar, R. (2021). G-TOPSIS: a cloud service selection framework using Gaussian TOPSIS for rank reversal problem. *The Journal of Supercomputing*, 77(1), 523-562.

Ulkhaq, M. M., Wijayanti, W. R., Zain, M. S., Baskara, E., & Leonita, W. (2018, March). Combining the AHP and TOPSIS to evaluate car selection. In *Proceedings of the 2nd International Conference on High Performance Compilation, Computing and Communications* (pp. 112-117).

Wu, L. Y., & Yang, Y. Z. (2008, July). TOPSIS method for green vendor selection in coal industry group. In *2008 international conference on machine learning and cybernetics* (Vol. 3, pp. 1721-1725). IEEE.

YAVAS, M., ERSOZ, T., Kabak, M., & Ersoz, F. (2014). Otomobil seçimine çok kriterli yaklaşım önerisi. *İşletme ve İktisat Çalışmaları Dergisi*, 2(4), 110-118.

YAVUZ, S. ÖĞRETMENLERİN OTOMOBİL TERCİHLERİNDE ETKİLİ OLAN FAKTÖRLERİN ANALİTİK HİYERARŞİ YÖNTEMİYLE BELİRLENMESİ. *Dumlupınar Üniversitesi Sosyal Bilimler Dergisi*, (32).



YERLİKAYA, M. A., & ARIKAN, F. (2017). AHP-KRİTİK TOPSİS BÜTÜNLEŞİK YAKLAŞIMI İLE AKREDİTASYON-TEMELLİ TEDARİKÇİ SEÇİMİ. *The International New Issues in Social Sciences*, 5(5), 627-635.



“

## Chapter 9

**ANALYSIS OF THE RUSSIA-UKRAINE  
WAR IN TERMS OF CLIMATE CRISIS  
POLICIES: THE CASE OF THE  
EUROPEAN UNION**

*Selçuk GÜRÇAM<sup>1</sup>*

”

---

<sup>1</sup> PhD, Independent researcher from Iğdır, Türkiye, selcukgrcm@gmail.com, ORCID: 0000-0003-0426-329X

## Introduction

The destructive and polluting effects of wars on the environment have been going on since the beginning of history. Environmental destruction has even been used as a war strategy to destroy enemies in wars. For example, the Russians, both Napoleon and In World War II, they left them in a difficult situation by destroying their own lands, agricultural areas and the environment in order to gain superiority against Hitler's armies. Although the effects of technological developments on the weapons industry are positive, the damage to the environment caused by weapons with high destructive power and wide range of influence has increased (Austin 2022; Karavelioğlu 2009:20–21). The environmental impact of wars has also been found in some academic studies. For example, Rawtani et al., (2022) and Pereira et al., (2022) examined the environmental problems posed by the Russo-Ukrainian war. He addressed issues such as the negative effects of damage to industrial zones on infrastructure and ecosystems, problems in water supply, poor sanitation, air pollution due to bombardment, nuclear risks, deforestation, and reduction of biodiversity. On the other hand, Rawtani et al. (2022) emphasized that reforms should be made to include environmental issues in international law, the International Criminal Court should be included in the scope of environmental crimes, and environmental problems should be among environmental issues. priorities of the international community. However, these studies generally examined the environmental effects of wars on the region. An example of these effects is that, according to a study published in the journal *Nature*, animal numbers can drop by an average of 90% during the war, while even a year of warfare can cause long-term wildlife loss. According to another study, after the long civil war in Mozambique, the biodiversity in Gorongosa National Park in Mozambique has disappeared by 95%. Likewise, more than 5 million acres of forest and 500 thousand acres of agricultural land were destroyed in the Vietnam War (McCarthy 2022). Especially in countries such as Iraq, Afghanistan and Pakistan, the effects of wars have caused serious damage to the natural environment. The high consumption of petroleum-based fuels by vehicles and equipment used in war zones causes greenhouse gases such as carbon monoxide (CO), nitrogen oxide (NO<sub>2</sub>), hydrocarbon (HC) and sulfur dioxide (SO<sub>2</sub>) as well as carbon dioxide (CO<sub>2</sub>) has a negative impact on the climate crisis (Crawford et al. 2022; Weir 2020).

The fight against the climate crisis is based on limiting the global average temperature to 1.5°C, if possible below 2°C compared to the pre-industrial period, within the limits set by the Paris Agreement. This agreement was ratified by 196 countries on 12 December 2015 and entered into force on 4 November 2016 (United Nations 2021b). Although 6 years

have passed, the COVID-19 epidemic has caused interruptions, but the desired success in the fight against the climate crisis has not been achieved. The main problem is that postponing the fight against the climate crisis will have irreversible consequences. In the statement made by the United Nations in 2018, current emissions need to be reduced by 45% by 2030 to keep the 1.5°C target alive. However, this target was only an estimate, and global emissions have since risen to levels not seen in human history (Hart and Wallace-Wells 2022).

In today's world, where the impact of the climate crisis is felt in almost every area, governments ignore the future of all living things for the sake of short-term interests and stay away from even implementing the agreements they have formed by coming together to fight. Despite this, the fight against the climate crisis was advancing, albeit slowly. However, the Russo-Ukrainian War caused the countries to reconsider their priorities. Policy makers' focus on the occupation, seeing military spending as a necessity, has forced investments to adapt to and minimize the effects of the climate crisis. In other words, the greenhouse gas emission rates caused by the armies in 2017 exceeded the greenhouse gas emission rates caused by countries such as Portugal, Sweden and Denmark. Andrew Sheng, member of the UNEP (United Nations Environment Programme) Advisory Council on Sustainable Finance, defines the current situation as "If war wins, climate action loses". As a reason, the increase in defense expenditures will accelerate the consumption of energy and non-renewable materials, cause an increase in emissions and thus divert scarce resources from the fight against the climate crisis (Bokat-Lindell 2022).

One of the most important effects of the war in Ukraine is the increase in high fuel prices with the war and as a result, the re-evaluation of the dependence of Western countries, especially Europe, on Russian oil and gas (Grajewski 2022; Tollefson 2022). The war has prompted political leaders to rethink their energy plans, which could have profound implications for a range of issues, from a burgeoning food crisis to global efforts to reduce greenhouse gas emissions (Tollefson 2022). Europe's transition to clean energy was accelerated by the war. In addition, in this period when global warming and especially the climate crisis become more visible, while the EU turns to coal and liquefied natural gas, dependence on fossil fuels should be stopped rapidly and gradually (Niranjan 2022).

In the report "Climate Change 2022: Impacts, Adaptation and Vulnerability" published by the IPCC in 2022, it warns that if measures are not taken and necessary steps are not taken, plans for a sustainable and livable future for all will be missed (IPCC 2022a). For this reason, the study deals with the changing energy policy especially in the axis of the EU and Germany, which are directly affected by the Russian-Ukrainian war. It

seeks answers to the impact of this change on current and future climate policy by asking the following questions: 1) What is the impact of the Russian-Ukrainian war on the current and future climate policies of the EU – positive or negative? 2) Will the targets set by the Paris Agreement and its implementations be completely moved away from or will a step towards the determined targets be taken? 3) Will the fight against the climate crisis be lost under the heat of coal? Although the study differs from other studies in terms of evaluating the political-climate policy-consequences of wars rather than its environmental effects, it will contribute to the studies to be conducted in terms of evaluating the climate crisis, which is generally considered in environmental sciences, within the framework of social sciences, that is, international relations.

### **Methodology**

This study focuses on the effect of the energy problem caused by the Russian-Ukrainian war on the climate policy of the European Union. The consequences of the energy crisis caused by the climate crisis and the Russian-Ukrainian war are examined in depth and with examples. In order to better understand the practices carried out in this context, the climate crisis and climate crisis policies, the Russian-Ukrainian war and the impact of this war on EU climate policies are discussed under separate headings. All these data are discussed separately in the discussion part, and the existing results and forward-looking projections are evaluated on the axis of the climate crisis. In the study, rather than the direct environmental effects caused by wars, the effects of the Russian-Ukrainian War on the EU climate crisis policy and its future are discussed more broadly.

### **Development of the Russia-Ukraine War**

Armed conflicts that started in the eastern part of Ukraine due to Russia's annexation of Crimea in 2014 ignited the road to the occupation of Ukraine, which is taking place today (Jones et al. 2021). Given the background of this annexation, the rejection of the agreement, which envisages greater economic integration with the European Union, by the President of Ukraine Viktor Yanukovich in 2013, caused protests that began in the capital, Kiev. The harsh intervention of the security forces in the protests caused conflict and the conflicts spread over a wide area (Snyder 2015). This situation caused President Viktor Yanukovich to leave the country in February 2014. One month after these events, Russia officially annexed the Crimea region of Ukraine by Russian President Vladimir Putin after the referendum on the annexation of Crimea to Russia, citing the protection of the rights of Russian citizens and Russian speakers in Crimea and southeast Ukraine. Although this crisis increased the ethnic division, a referendum was held by the Russian separatists in the Ukrainian cities of

Donetsk and Luhansk, as in the Crimea, to declare independence. After a short time, armed clashes started between Russian and Ukrainian forces in the region (Beauchamp 2022; Council on Foreign Relations 2022).

In 2015, an agreement was reached on negotiations between Germany, France, Russia and Ukraine to stop the ongoing violence between Russia and Ukraine. Within the scope of the agreement, articles were found that included the withdrawal of heavy weapons, the declaration of a ceasefire and the full control of Ukraine in conflict areas. However, the steps taken have drawn an image that is far from solving the problem diplomatically and the desired success has not been achieved. In 2016, the North Atlantic Treaty Organization (NATO) announced that it would deploy troops in various parts of Europe, especially in Eastern Europe, and that it would send these troops through Estonia, Latvia, Lithuania and Poland, with the thought of creating a deterrent effect on Russia. In 2017, NATO deployed two tank brigades of the United States (US) to Poland to strengthen its presence in the region. In 2018, 9 companies and some Russian officials related to the conflicts in Ukraine were sanctioned by the USA. On the same date, the USA approved the sale of anti-tank weapons to Ukraine. However, right after the extensive military exercise carried out by Russia in 2018, Ukraine organized an exercise with the participation of the USA and some NATO countries (Beauchamp, 2022; Council on Foreign Relations, 2022).

In a statement issued by the Russian Foreign Ministry in 2021, NATO and the United States are requested to cease their military activities in Eastern Europe and Central Asia, to promise no further NATO enlargement, and to prevent Ukraine from joining NATO. However, although this statement was not accepted by the USA and NATO, they warned that Russia would be subject to heavy economic sanctions in case of an invasion attempt against Ukraine. In addition, military aid, including military equipment, ammunition and small arms, was provided to Ukraine by the United States (Council on Foreign Relations 2022).

The actions taken by Ukraine – pro-Western – are perceived as a constant threat by Vladimir Putin and this situation puts Russia in a situation where it cannot feel safe, World War II. It started the biggest war (Kirby 2022) in Europe since World War II on February 24, 2022 (Council on Foreign Relations 2022). The first purpose of Putin to start this war; It is to overthrow the government by capturing Ukraine, to hinder these aims and to end the desire of Ukraine, which pursues Western goals, to join NATO. In terms of his own people, the reason why he started a war against Ukraine; By preventing the violence and genocide that has been going on for 8 years in Ukraine, he explained it as clearing Ukraine from the soldiers and Nazis that he saw as a threat to his country. At the same

time, the Russian leader described this entry as a noble cause (Kirby 2022). However, this occupation ceased to be a war between two states and caused a global energy and climate policy problem that affected the whole world and its future.

### **General Development of Climate Crisis Policies**

With the industrial use of coal and the invention of the steam engine in the 18th century, a new era in human history opened (Fernihough and O'Rourke 2014; Galloway 2015; Kerker 1961; Scherer 1965). In order to better understand the increase in greenhouse gases causing the climate crisis in the following paragraphs, the greenhouse gas rate in the atmosphere was approximately 290 ppm (particles per million) in the 1800s, while the global temperature was measured as an average of 13.6°C (Gervet 2007:7; Hashimoto 2019; Moron 2013; Murray 1994). In the second half of the 19th century, scientist John Tyndall discovered the separate heat-retention properties of gases (water vapor, “carbonic acid” (now known as carbon dioxide), ozone and hydrocarbons) and water vapor (Gray 2004; Hulme 2009; Jackson 2020:105). In this period, the development of the industry increased the use of hard coal, railways and land reclamation, and therefore the increased level of welfare had a positive effect on population growth.

Since the first half of the 1900s, drilling oil wells in Texas and the Basra region started the cheap energy era and accelerated greenhouse gas emissions (Gürçam 2021:113). In the measurements made in 1938 by the British engineer Guy Callendar based on the data of 147 weather stations, it was determined that the global average temperatures increased compared to the previous century and the CO<sub>2</sub> rates increased in this period. He also suggested that this situation causes an increase in temperature (Anderson, Hawkins, and Jones 2016:182; Uprety, Reddy, and Mura 2019). Investigations were made on various gases with a device developed by the US scientist Gilbert Plass in 1955. As a result of this examination, it was determined that the increase in CO<sub>2</sub> emissions was related to the increase in temperature in direct proportion to the view put forward by Guy Callendar (Plass 1956). In support of this thesis, in 1958, US scientist Charles David (Dave) Keeling presented the first evidence that CO<sub>2</sub> emissions increased (313 ppm) as a result of measurements of atmospheric CO<sub>2</sub> emissions in Hawaii's Mauna Loa and Antarctica (American Chemical Society 2022; Peterman 2017:7).

The United Nations Conference on the Human Environment (UNCHE) was held from 5 to 16 June 1972 in Stockholm, Sweden. At this conference, for the first time, world leaders and scientists came together to discuss growing international environmental issues such as cross-border. As a result of the conference, the United Nations Environment Program (UNEP)



was established (Andler and Behrle 2009; Handl 2012). The first serious step against the negative effects of carbon dioxide concentrations was the First World Climate Conference in 1979, led by the World Meteorological Organization (WMO). At this conference, the importance of the subject was brought to the attention of the countries of the world. Another international initiative is the meeting held in Villach, Austria by the World Climate Program (WCP) in 1985 (Türkeş 2001:1). The issues mentioned in the Villach conference on “Our Common Future or the Brundtland Report” presented by the World Commission on Environment and Development in 1987 were re-addressed and renewable energy was emphasized by mentioning the energy issue (Holden, Linnerud, and Banister 2014:131; Keeble 1988). In 1988, the Changing Atmosphere Toronto Conference called for strict and special restrictions to reduce greenhouse gas emissions (Gürçam 2021:114; Paterson 2013).

The Intergovernmental Panel on Climate Change (IPCC) was established in 1988 by the WMO and UNEP. After this date, the IPCC contributes to drawing a scientifically based path in the fight against the climate crisis with the data it provides to the whole world. The main purpose of the IPCC is to evaluate the available information about the climate crisis and to enlighten policy makers and the public about the climate crisis (Agrawala 1998; Asayama and Ishii 2014). In the first evaluation report published by the IPCC in 1990, it was stated that the world is warming and this warming will probably continue in the future. He stated that temperatures have increased between 0.3-0.6°C in the last century and that humanity can contribute to the increase of greenhouse gases, which are a component of the atmosphere (IPCC 1990:80).

Held between 29 October-7 November 1990, the II. While great efforts were made to raise awareness about the climate crisis with the World Climate Conference, the global dimension of the climate crisis was mentioned with the Ministerial Conference. However, since it was necessary to work on a text for the struggle against the climate crisis to gain more validity, the General Assembly decided to convene the United Nations Environment and Development Conference in Rio de Janeiro in 1992. In 1992, the UN Framework Convention on Climate Change was adopted, which includes the issues that will stabilize or reduce the impact of anthropogenic greenhouse gases on the climate crisis (Kuyper, Schroeder, and Linnér 2018; Schipper 2006; WMO 2009).

The 2nd Assessment Report, published by the IPCC in 1995, concluded that there is now a noticeable human impact on the earth’s temperature. This report was the first definitive statement that humanity was responsible for the greenhouse effect and thus global warming. At the same time, the publication of reports on the breaking up of existing glaciers on the

Antarctic continent drew public attention to global warming (Edwards and Stephen 2001; IPCC 1995).

Since the UNFCCC does not have a result-oriented application obligation in the fight against the climate crisis, the Kyoto Protocol, which includes clearer steps, was adopted at the Third Parties Conference in 1997 (Bohringer 2003). The most important feature that distinguishes the Kyoto Protocol, which entered into force in 2005, from the UNFCCC; It has set binding targets for reducing greenhouse gas emissions in 37 industrialized countries and the European Union. This target is defined as reducing the greenhouse gas emissions of the countries that have accepted the protocol between 2008 and 2012 by 5% below the 1990 level on average (Barrett 1998; United Nations 2021c). However, the protocol did not meet the expectations in terms of combating the climate crisis, due to the USA's withdrawal from the protocol in 2001 and its entry into force 8 years after the protocol was signed in 1997.

The IPCC's findings on the climate crisis were also shared with policy makers and the public in the 3rd Assessment Report, published at the beginning of the 21st century (in 2001). This report provides compelling evidence that the temperature rise experienced in the late 20th century was due to greenhouse gas emissions from humanity. It is stated that the deadly heat waves, huge hurricanes and other extreme weather events that are already occurring will be exacerbated in the future (IPCC 2001). While the average global carbon dioxide concentration was 280 ppm in the pre-industrial period, it was measured as 379 ppm in 2005 (Ahmed et al. 2013:320; Furuya and Kobayashi 2009:71). This increase was also highlighted in the IPCC's 4th Assessment Report published in 2007. In this report, as in other reports, it was emphasized that the human impact on the climate crisis (carbon dioxide, methane, and nitrous oxide levels) increased compared to the previous year (IPCC 2007). Arctic sea ice, which was started to be measured in 1979, was found at its lowest level with 3.41 million km<sup>2</sup> in 2012 (Liu et al. 2013:12571; Zhang and Knutson 2013). The CO<sub>2</sub> concentration of 400 ppm, measured at the Mauna Loa Observatory in Hawaii in 2013, was the highest level measured since 1958 (Blunden 2014).

The 5th Assessment Report of the IPCC, which states that the human impact on the climate crisis is at the level of 95%, was published in 2013 (IPCC 2013). In 2015, following the Kyoto Protocol (United Nations 2021c), the Paris Agreement was signed, which will determine the fate of the fight against the climate crisis. In the agreement, which was accepted by 196 countries, it was stated that emission reduction targets should be determined regardless of the country (United Nations 2021d). It was also stated that despite all this, the parties could not agree on taking more result-

oriented steps that require a solution within the framework of the Paris Agreement (IPCC 2018).

In 2019, UN Secretary General Antonio Guterres called on the world states before the COP/25 and stated that this conference had a chance to exchange ideas on the revision and presentation of the declarations of contribution to be submitted in 2020. The parties will present a plan to reduce greenhouse gas emissions by 45% by 2030 and achieve carbon neutrality by 2050. However, most countries, including China and the USA, which have the largest share in world greenhouse gas emissions, do not agree with this call (United Nations 2019). Described as a missed opportunity by Secretary General Guterres, CO<sub>2</sub> concentrations rose to 415 ppm during the COP/25 period, reaching the highest level in millions of years (Dockrill 2019). In the statement published as a result of the conference, there is no call for countries to update their contribution declarations under the Paris Agreement and to increase their emission reduction rates. In addition, despite the terrible warnings of scientists and all the protests in the world, it is clearly seen that the lack of progress in the fight against climate change is due to the attitude of the countries (Council on Foreign Relations 2021).

Due to the COVID-19 pandemic in 2020, the 26th meeting of the Conference of the Parties (COP/26) planned in November 2020 was postponed to 2021 by the UN (Council on Foreign Relations 2021). However, a year later, it took place in Glasgow, Scotland, between 31 October and 13 November 2021 (Rust 2022). As a result of this meeting, it was stated that the world is far from the 1.5°C targets set by the Paris Agreement, and therefore, possible global temperatures will be above 3°C until 2100. If world countries do not change their current positions, they will have to face more disasters such as temperature increases, extreme climate events, severe floods, forest fires and extinction of other living species (United Nations 2022). With COP/26, the reduction of fossil fuel use was included in the final declaration of a climate summit for the first time. A just transition to clean energy and coal exit was at the center of the COP/26 talks to ensure that global average temperatures are minimized within the framework of the Paris Agreement. The Glasgow summit signaled the world's progress towards renewable energy. At the summit, at least 23 countries, including five of the world's top 20 coal-using countries, committed to phase out coal for energy purposes (United Nations 2021a).

On November 5, 2021, a total of 47 countries ratified the clean energy transition and coal exit agreement. Canada, Belgium, Chile, Denmark, Egypt, Germany and France are the leading signatories. The articles committed by the agreement are as follows: a) Measures for clean energy production and dissemination of energy efficiency should be provided with the support of the Energy Conversion Council. b) By 2030 for major

economies and by 2040 for other economies, develop technologies and policies for coal exit with support from the Coal Alliance Strengthening History (PPCA). c) The prevention of new coal projects and new construction and the support of governments to such initiatives should be stopped. d) Necessary financial, technical and social support should be provided to the sectors and workers that will be affected by the coal output through local and international efforts (Moazzem 2021).

In the 6th report published by the IPCC in April 2022, the following points briefly draw attention: a) If the world really wants to meet the 1.5°C targets set by the Paris Agreement, the use of coal must be clearly stopped. However, current continued use of fossil fuels will cause the world to exceed the 1.5°C target. b) Emissions of methane emissions should be reduced by one third. c) Expansion of forest areas and protection of soils is essential, but planting trees is not sufficient to prevent emissions of greenhouse gas emissions. d) Steps towards a lower carbon world are about six times lower than they should be. e) Existing sectors such as energy, transportation, food production, and construction must undergo rapid change, and technologies such as hydrogen fuel, carbon capture, and storage are needed to reduce emissions. f) In addition, it was emphasized in the report that renewable energy production can be produced cheaper than in the past (IPCC 2022b). The IPCC stated that global warming is increasing rapidly and adaptation may become impossible in the near future (IPCC 2022a). Similarly, United Nations Secretary General Antonio Guterres made a statement regarding global warming as “Delay means death” (Spring, Januta, and Dickie 2022).

## **Results**

This section has been analyzed under 5 headings. While the current results of the Russia-Ukraine war were included in the first title, the current climate policies of the EU and especially Germany, which were directly affected by the Russia-Ukraine war in energy, and the changing climate policies with the war were included in the second title.

### **Current Consequences of the Russo-Ukrainian War**

Russian leader Putin probably did not anticipate that the war he started would cause such big problems. Heavy sanctions against the Russian economy have been one of the biggest problems caused by the war for Russia. In fact, these sanctions threaten to shrink the Russian economy by 10%. The details of the EU, USA, UK, and other Western countries' sanctions against the Russian economy are as follows (Kirby 2022; Maksym Chepeliev and Mensbrughe 2022):

a) Russia's major banks were removed from the international SWIFT

payment transfer network, while the assets of the Central Bank of Russia were frozen (Kirby 2022).

b) While the import of Russian oil and natural gas was banned by the USA, the EU aimed to reduce it by two thirds within a year. The UK, on the other hand, aims to gradually end its dependence on Russian oil by the end of 2022.

c) EU, Canada, USA, and UK closed their airspaces to the passage of Russian planes.

d) Personal sanctions were imposed on Russian leader Putin and her family, Foreign Minister Sergey Lavrov, and many Russian citizens (Council on Foreign Relations 2022; Kirby 2022).

e) 31 countries around the world have agreed to extract oil from their strategic reserves.

f) This occupation by Russia caused extraordinary activity both in the energy markets and in the current energy geopolitics. Especially oil and natural gas prices have started to hover above the last ten years. This situation has forced many countries, especially European countries, to reevaluate their energy resources (Tollefson 2022).

The biggest problem that occupied the world after the Russia-Ukraine War is the energy problem. Especially how to cut the dependence on Russia in energy. Countries with low dependence on oil, such as the USA and the UK, were the first to ban Russian oil. For Russia, this is not a big problem as resources can be diverted in different directions. However, the main issue that poses a problem for Russia is the EU's participation in these sanctions. In other words, it is not possible for Russia to find new customers to which it can quickly direct the oil and natural gas it transfers to the EU (Reuters 2022; Tollefson 2022).

According to the Center for Strategic and International Studies (CSIS), the Russian-Ukrainian war will affect Europe's shift away from fossil fuels and accelerate its transition to renewable energy, but in other regions it may be the other way around. That is, Southeast Asia in particular may focus on coal as it dominates the global liquefied natural gas market to meet European gas supplies (Tollefson 2022).

### **European Union General Climate Policy**

The EU has rolled up its sleeves to create its own climate policy, accompanied by the guide to combating the climate crisis (UNFCCC), which was finalized in a written text in 1992. In particular, within the scope of the Kyoto Protocol, which took more decisive steps after the UNFCCC, it has committed to reduce greenhouse gas emissions by 8% for the first

emission reduction period (2008-2012) (Bayer and Aklin 2020:8805; Rayner and Jordan 2016).

The EU has decided to take more inclusive steps to create a climate-friendly economy. In 2015, within the framework of the Paris Agreement, the EU committed to reduce its emissions by at least 40% on the basis of 1990 by 2030 with the Nationally Determined Contribution statement, while with the European Green Agreement, it committed to reduce its emissions by 55% compared to 1990 emission levels by 2030 and to neutralize its emissions by 2050 has continued its leadership attitude in the fight against the climate crisis from the very beginning. In order for the EU to reach this target, it should stay away from all initiatives that cause greenhouse gas emissions as much as possible. The main tools of the EU in achieving these goals are the Emissions Trading System (EU ETS) and the Effort Sharing Regulation (ESR). While ETS is geared towards reducing emissions from energy and industry, ESR is geared towards non-ETS sectors (such as the transport, buildings and agriculture sectors, and small industrial facilities) (BMUV 2020; Maksym Chepeliev and Mensbrughe 2022; Nummelin 2022).

In addition to the efforts towards its own climate targets, the EU is the largest public financer contributing to the fight against the climate crisis outside its borders with 23.3 billion Euros worth of funds (European Council 2022).

### **The Changing Climate Policy of the European Union After the Russia-Ukraine War**

Today, no country is in a position where its borders are covered with walls and unaffected by the outside world. We live in the age of industry and mass production, where one country or region meets the needs of another country or region. The steps taken by the USA to the EU to ban Russian fossil fuels, although aimed at cutting the financing of the Russian army, are steps that both sides have to pay for (Giussani 2022; Khan 2022). While the USA decided to impose sanctions against Russian fossil fuels, the UK announced that it would stop purchasing oil from Russia. The European Union has decided to reduce natural gas imports from Russia by 80% until the end of the year and to phase out coal and oil purchases from Russia until 2027 (Niranjan 2022).

The fossil fuel war has created an energy crisis that can cause high inflation in the US and European markets. Namely, it should not be forgotten that 40% of European gas comes from Russia and its cost is 180 million dollars per day. This situation is a sign of how much European countries, especially Germany, are dependent on Russian fossil fuels and that they may turn to coal to close the possible energy gap (Giussani 2022; Khan



2022). Namely, the Greek government has announced that coal extraction will continue and the use of coal-fired power plants (approximately 10% of electrical energy) planned to be closed will be extended to 2028. In Italy, which meets 45% of its natural gas need from Russia, after the Russian occupation, Italian Prime Minister Mario Draghi announced that coal-fired power plants could be reactivated in order to eliminate the energy deficiencies. Although Poland has planned to end coal use in 2049, even this distant target is open to the discussion today. Czechia, on the other hand, was planning to end the use of coal in 2033, but the government said that this plan should be reviewed on the axis of benefit-harm under current conditions. In Romania, Minister of Environment Barna Tánzos announced that inactive coal-fired power plants will be reactivated. However, this situation is seen as the most impossible step in terms of the targets set in the fight against the climate crisis (Wanat 2022).

The European Commission has launched the REPowerEU Plan in order to get rid of the negative impact of Russia's occupation of Ukraine on the global energy market and for a cleaner future. This plan offers a way to get rid of dependence on Russian fossil fuels, transform energy systems and fight the climate crisis. Namely, saving energy, diversifying energy sources and replacing fossil fuels with renewable energy sources, increasing the share of renewable energy in homes, industry and energy production are the main elements of the plan (European Commission 2022). In addition, the plan includes diversifying gas sources through the production and import of higher Liquefied Natural Gas (LNG) and larger volumes of biomethane and renewable hydrogen from non-Russian suppliers (Morrow 2022). In this direction: a) The construction of LNG import facilities in the EU, mainly in Germany, Italy, Greece, and the Netherlands, is planned. b) An agreement was signed between the USA and the EU to export LNG. c) Likewise, agreements for LNG export were signed with Qatar and Egypt. d) Algeria signed an additional agreement to export natural gas to Italy via pipeline. e) It is planned to revive the old pipeline projects (such as Nigeria) that existed in the past in Africa. Even countries that do not export fossil fuels (such as Senegal) are encouraged to supply gas to Europe. f) While fossil fuel production has increased in countries such as the USA, Canada, Norway, Italy, and Japan, countries such as the UK, EU, Germany, Poland, and Italy have signed or extended long-term fossil fuel contracts (CAT 2022).

### **Germany's General Climate Policy**

Germany adopted the German Federal Climate Change Act, the first climate law adopted in 2019 and amended in 2021, in line with EU emission reduction plans (Appunn, Eriksen, and Wettengel 2021). This law aims to be carbon neutral by 2045 in the fight against the climate crisis. It

plans to reduce CO<sub>2</sub> reductions in individual sectors, including the energy, transport, and construction sectors, by 65% by 2030 and by 88% by 2040, based on emission levels for 1990 (Bundesregierung 2021; Library of Congress 2022) . The law states that Germany's national climate targets can be raised but not lowered. Germany is also one of the few countries that aim to be carbon neutral by 2050. Compared to 1990, German emissions were reduced by 40.8%. This reduction shows that it meets the set targets. Greenhouse gas reduction targets set for 2020 have been achieved in all sectors except the construction sector. By 2050, the electricity produced in Germany must be carbon neutral as per the Renewable Energy Act (EEG) law. However, it has been determined that the share of renewable energy consumption in total energy consumption will be 65% by 2030. In 2020, the share of renewable energy consumption in total energy consumption was 46%. It is seen that among the renewable energy sources produced in Germany, hydroelectricity production is low compared to other countries, and it concentrates more on energy sources such as wind and solar (Appunn et al. 2021).

Coal is one of the fossil fuels that causes the most CO<sub>2</sub> emissions in terms of the climate crisis. In this respect, Germany is one of the few countries that aims to exit from coal energy production in line with its climate crisis targets. In line with its climate targets, Germany initially aimed to phase out coal by 2038. However, this target was pushed back to 2030 in 2021 in line with government decisions made up of the Social Democratic Party of Germany (SDP), the Green Party and the Free Democratic Party (FDP). German Government Chancellor Olaf Scholz announced that they plan to increase the share of renewable energy and even meet 80% of its energy needs from solar and wind energy by 2030 (Fazit Communication 2022).

### **Germany's Changing Climate Policy After the Russia-Ukraine War**

Russia's invasion of Ukraine caused some of the world's largest fossil fuel companies to decide to withdraw from Russia, giving up nearly \$20 billion in annual revenue. Germany – Russia's largest natural gas customer – has decided to stop the construction of the Nord Stream 2 gas pipeline (Niranjan 2022; Tollefson 2022). Since Germany is dependent on Russia for half of natural gas and coal and more than one third of oil, difficult times await, especially in terms of the energy crisis (Tollefson 2022). Because, together with the exit from nuclear energy, the last three power plants will be closed this year (Deutsche Welle 2022), and Germany needs to change its plan in order to save the electricity sector from dependence on natural gas (Tollefson 2022).



After the Russian occupation, Germany announced that it plans to accelerate its investments in clean energy – such as wind turbines and solar panels. In fact, Germany has announced that it has committed 200 billion Euros to decarbonize electricity generation by 2035. However, Russia has promised to build two liquefied natural gas terminals to avoid dependence on fossil fuels. However, the short-term energy crisis and rising prices, and the lack of reliability of Russian natural gas – the possibility of Russian leader Putin’s interruption of natural gas flow - led to talk of a return to coal, which poses a risk in terms of climate crisis in the European Union, including Germany (Niranjan 2022). With the global energy crisis, the government announced that the termination of the activities of coal-fired power plants was suspended until further notice (Meredith 2022; Storbeck and Sheppard 2022; Wanat 2022). However, German Economy and Climate Minister Robert Habeck made a statement that if you want to harm Russian leader Putin due to the Russian invasion, save energy. Similarly, Ursula von der Leyen, President of the European Commission, said that by saving energy all together, they will get rid of the dependency on fossil fuels, especially Russian natural gas (Niranjan 2022).

Between 2022 and 2026, the money allocated by Germany for renewable energy investments is 200 billion Euros. According to Thijs Van De Graaf, Professor of International Politics at Ghent University, every step taken to get rid of energy dependence on International Policy Russia is the same as the policies used to reduce emissions in the fight against the climate crisis. In fact, this war can be seen as a super opportunity for the energy transition in terms of climate crisis (Bokat-Lindell 2022).

### **Discussion**

Although investments in renewable energy and green hydrogen accelerated after the Russian occupation, this is not sufficient. In other words, it will be clear in the coming years whether the steps taken towards an emission-free economy or renewable energy production will achieve the 1.5°C targets set by the Paris Agreement. However, the steps taken by the EU to meet its short-term energy needs seem to endanger its climate policies. Efforts to build new natural gas infrastructure in order to end dependence on Russian gas are very close to putting the world on an irreversible path. Because there is a tendency towards fossil fuels rather than decarbonizing economies (CAT 2022). UN Secretary General Antonio Guterres states that the energy crisis caused by the Russian-Ukrainian War and the tendency of fossil fuels to meet energy needs threaten the goals of the global climate crisis. Namely, due to the occupation of Ukraine, the sanctions of countries against Russia and the plans to move away from Russian fossil fuels caused rapid increases in energy prices. Guterres emphasizes that the search for alternative fossil fuels by countries will

undermine the Paris Climate Agreement targets and this chapter may be closed. Because the needs of countries to reduce dependence on Russian fossil fuels lead countries to coal and liquefied natural gas. However, this situation worsens the situation, while the desired level of struggle has not been achieved in terms of the climate crisis. Because countries may tend to consume too much fossil fuel due to the energy supply deficit, and this may upset the climate crisis policies and plans (Harvey 2022; McGrath 2022). According to Climate Analytics CEO Bill Hare, the international community has missed post-pandemic opportunities to decarbonize the economy. The current crisis shows the same opportunities again but indicates that the experiences will be repeated. The point he especially emphasizes is that, be it a pandemic, conflict, or short-term shocks, none of them should ignore the climate crisis and allow steps to be taken that will lead the world to disaster (CAT 2022).

The outbreak of the Russian-Ukrainian war adversely affects global cooperation in the fight against the climate crisis - the cooperation that is not at the desired level - and the functioning of climate policies. As can be seen especially in the latest report published by the IPCC; If environmental degradation is increasing more than ever, the current struggle is not sufficient to combat the climate crisis, and unless action is taken now, many parts of the world will become uninhabitable in the next few decades. But to be realistic, who takes into account the grave situation in the report published by the IPCC, or in which organizations and news channels it is expressed? The answer to the questions asked is obvious: Of course, our answer is not expressed by any channel or organization, because of the focus of the global community: the Russian-Ukrainian conflict. In other words, the future of the world is in the shadow of the current Russian-Ukrainian conflict. Now the following question comes to mind: Is the climate crisis over? Or does it not matter now? We certainly know the answer (of course, it continues without slowing down) but today we see how conflicts and wars can change our priorities and how countries can put wars at the center of focus, no matter how important environmental problems such as the climate crisis are (Khan 2022).

Another problem caused by the war apart from the energy crisis is the disruption of renewable energy investments. Because both Russia and Ukraine are the main suppliers of metal parts – copper, nickel, platinum, palladium, aluminum, and lithium – used in the production of renewable energy types such as solar panels, wind turbines, and electric vehicle batteries. This conflict threatens this transition or material supply (Sharma 2022). Another problem is that the environment created by the occupation of Russia poses perhaps the greatest challenge for the climate crisis: Global distancing. Because the basic solution to the climate crisis is real and

determined cooperation. In the last few years, the fight against the climate crisis, especially the intense pressure of youth movements, the occurrence of forest fires, floods, droughts, heat waves, and extreme weather events in various parts of the world have increased the existing concerns. At this point, the fight against the climate crisis needs a global cooperation. Russia's invasion of Ukraine and the economic sanctions imposed in response to the West's reaction to this situation make cooperation more and more difficult, if not an absolute obstacle (Giussani 2022).

At a time when the effects of the climate crisis are being felt, the main reason why climate policies are pushed into the background and the energy crisis that the EU is going through is a major problem; lies in wrong and unsustainable climate policies. If the EU had followed a path based on renewable energy sources in its climate policies and energy production, it would not have been able to experience the current energy problem since the negotiations and climate policies to combat the global climate crisis that started in the 1990s. could have been more effective. Sustainable for the future of the world However, not paying enough attention to climate policies, following wrong policies or hiding behind greenwashing lies at the root of the EU's energy crisis. In the 1990s, instead of increasing its dependence on Russian gas, it could have accelerated its investments in renewable energy and fulfilled its climate commitments both to solve the energy problem and to fulfill its climate leadership position in essence, not in words.

### **Conclusion and Recommendations**

As in the past, environmental problems have always been ignored, except for a small group of people who are conscious and growing. This has been even more brutal in terms of the climate crisis, which has truly devastating effects and is increasing these effects. Against a global problem with visible effects, the orientation toward the elements that completely affect it -fossil fuels- is destructive steps that are not sustainable today as it was in the past.

The Russian-Ukrainian war has had an impact on both energy balances and climate policies at the global and EU level. In order to get rid of this devastating effect, the EU took refuge in fossil fuels, which are the executioners of the world. It may even obtain and use more fossil fuels than it did in the past in order to secure itself in the future.

We can say that the Russian-Ukrainian war is the biggest visible and regrettable proof of this chain of negligence for the EU. The EU should especially learn from this war and not prefer renewable energy to cheap and destructive fossil fuels. There is no longer any room for wasted time or steps to be wasted. The short-term steps taken in energy production should

not be permanent, their place should be filled with more sustainable energy investments and energy savings as soon as possible. The increase in the prices of fossil fuels and vehicles used in renewable energy production, especially with the war, may cause the EU's short-term coal investments to prolong. This situation, on the other hand, may further increase the distance between Europe and the world from the 1.5oC target, which was insistently emphasized by the Paris Agreement. In fact, for the EU, the only factor that will increase its orientation towards renewable energy in terms of both getting rid of dependency on fossil fuels and meeting the climate crisis targets is; the use of nuclear energy. Rather than turning to coal or other fossil fuels, the use of nuclear energy will both facilitate compliance with the Paris Agreement and the European Green Deal targets and will ensure that investment in fossil fuels is allocated to renewable energy sources. Thus, both targets will be achieved and there will be a cleaner development.

## REFERENCES

- Agrawala, Shardul. 1998. "Context and Early Origins of the Intergovernmental Panel on Climate Change." *Climatic Change* 605–620.
- Ahmed, Kazi Farzan, Guiling Wang, John Silander, Adam M. Wilson, Jenica M. Allen, Radley Horton, and Richard Anyah. 2013. "Statistical Downscaling and Bias Correction of Climate Model Outputs for Climate Change Impact Assessment in the U.S. Northeast." *Global and Planetary Change* 100:320–32. doi: 10.1016/j.gloplacha.2012.11.003.
- American Chemical Society. 2022. "The Keeling Curve: Carbon Dioxide Measurements at Mauna Loa." Retrieved (<https://www.acs.org/content/acs/en/education/whatischemistry/landmarks/keeling-curve.html>).
- Anderson, Thomas R., Ed Hawkins, and Philip D. Jones. 2016. "CO<sub>2</sub>, the Greenhouse Effect and Global Warming: From the Pioneering Work of Arrhenius and Callendar to Today's Earth System Models." *Endeavour* 40(3):178–87. doi: 10.1016/J.ENDEAVOUR.2016.07.002.
- Andler, Lydia, and Steffen Behrle. 2009. *Managers of Global Change: The Influence of International Environmental Bureaucracies*. MIT Press.
- Appunn, Kerstine, Freja Eriksen, and Julian Wettengel. 2021. "Germany's Greenhouse Gas Emissions and Energy Transition Targets." *Clean Energy Wire*. Retrieved (<https://www.cleanenergywire.org/factsheets/germanys-greenhouse-gas-emissions-and-climate-targets>).
- Asayama, Shinichiro, and Atsushi Ishii. 2014. "Reconstruction of the Boundary between Climate Science and Politics: The IPCC in the Japanese Mass Media, 1988–2007." *Public Understanding of Science* 23(2):189–203. doi: 10.1177/0963662512450989.
- Austin, Jay. 2022. "War." Retrieved (<http://www.pollutionissues.com/Ve-Z/War.html>).
- Barrett, S. 1998. "Political Economy of the Kyoto Protocol." *Oxford Review of Economic Policy* 14(4):20–39. doi: 10.1093/oxrep/14.4.20.
- Bayer, Patrick, and Michaël Aklin. 2020. "The European Union Emissions Trading System Reduced CO<sub>2</sub> Emissions despite Low Prices." *Proceedings of the National Academy of Sciences* 117(16):8804–12. doi: 10.1073/pnas.1918128117.
- Beauchamp, Zack. 2022. "9 Big Questions about Russia's War in Ukraine, Answered." *Voxmedia*. Retrieved (<https://www.vox.com/22989379/russia-ukraine-war-putin-zelensky-us-nato-explainer-questions>).
- Blunden, Jessica. 2014. "2013 State of the Climate: Carbon Dioxide Tops 400 Ppm." *Climate.Gov*. Retrieved (<https://www.climate.gov/news-features/understanding-climate/2013-state-climate-carbon-dioxide-tops-400-ppm>).

- BMUV. 2020. “EU Climate and Energy Policy.” *Federal Ministry for the Environment, Nature Conservation, Nuclear Safety and Consumer Protection*. Retrieved (<https://www.bmu.de/en/topics/climate-adaptation/climate-protection/eu-climate-policy>).
- Bohringer, C. 2003. “The Kyoto Protocol: A Review and Perspectives.” *Oxford Review of Economic Policy* 19(3):451–66. doi: 10.1093/oxrep/19.3.451.
- Bokat-Lindell, Spencer. 2022. “What the Ukraine War Means for the Future of Climate Change.” *The New York Times Company*. Retrieved (<https://www.nytimes.com/2022/03/16/opinion/ukraine-climate-change-russia.html>).
- Bundesregierung. 2021. “Intergenerational Contract for the Climate.” Retrieved (<https://www.bundesregierung.de/breg-de/themen/klimaschutz/climate-change-act-2021-1936846>).
- CAT. 2022. “Global Reaction to Energy Crisis Risks Zero Carbon Transition.” Retrieved (<https://climateactiontracker.org/publications/global-reaction-to-energy-crisis-risks-zero-carbon-transition/>).
- Council on Foreign Relations. 2021. “Timeline: UN Climate Talks.” Retrieved December 10, 2021 (<https://www.cfr.org/timeline/un-climate-talks>).
- Council on Foreign Relations. 2022. “Conflict in Ukraine.” Retrieved (<https://www.cfr.org/global-conflict-tracker/conflict/conflict-ukraine>).
- Crawford, Neta C., Bridget Guarasci, Robert Miller, Kali Rubai, and Mac Ískelet. 2022. “Environmental Costs.” *Brown University*. Retrieved (<https://watson.brown.edu/costsofwar/costs/social/environment>).
- Deutsche Welle. 2022. “Almanya Üç Nükleer Santralin Fişini Çekti.” Retrieved (<https://www.dw.com/tr/almanya-uc-nukleer-santralin-fisini-çekti/a-60307310>).
- Dockrill, Peter. 2019. “It’s Official: Atmospheric CO2 Just Exceeded 415 Ppm For The First Time in Human History.” *Science Alert*. Retrieved (<https://www.sciencealert.com/it-s-official-atmospheric-co2-just-exceeded-415-ppm-for-first-time-in-human-history>).
- Edwards, Paul N., and H. Schneider Stephen. 2001. “Self-Governance and Peer Review in Science-for-Policy: The Case of the IPCC Second Assessment Report.” Pp. 219–46 in *Changing the atmosphere: Expert knowledge and environmental governance*.
- European Commission. 2022. “REPowerEU: A Plan to Rapidly Reduce Dependence on Russian Fossil Fuels and Fast Forward the Green Transition.” Retrieved ([https://ec.europa.eu/commission/presscorner/detail/en/IP\\_22\\_3131](https://ec.europa.eu/commission/presscorner/detail/en/IP_22_3131)).
- European Council. 2022. “Climate Goals and the EU’s External Policy.” Retrieved (<https://www.consilium.europa.eu/en/policies/climate-change/climate-external-policy/>).

- Fazit Communication. 2022. "A Pioneer in Climate Policy." Retrieved (<https://www.tatsachen-ueber-deutschland.de/en/germany-glance/pioneer-climate-policy>).
- Fernihough, Alan, and Kevin Hjortshøj O'Rourke. 2014. *Coal and the European Industrial Revolution*. Cambridge, MA.
- Furuya, Jun, and Shintaro Kobayashi. 2009. "Impact of Global Warming on Agricultural Product Markets: Stochastic World Food Model Analysis." *Sustainability Science* 4(1):71–79. doi: 10.1007/s11625-008-0062-0.
- Galloway, Elijah. 2015. *History Of The Steam Engine, From Its Earliest Invention To The Present Time*. Sagwan Press.
- Gervet, Bruno. 2007. *Global Warming Is Mainly a Result of Heat Emissions*. Luleå, Sweden: 26.08.2022.
- Giussani, Bruno. 2022. "Why the War in Ukraine Is Also a Make-or-Break Moment for Climate Change." *TED Talks Usage Policy*. Retrieved (<https://ideas.ted.com/why-the-war-in-ukraine-is-also-a-make-or-break-moment-for-climate-change/>).
- Grajewski, Marcin. 2022. *The Ukraine War and Energy Supply*.
- Gray, Vincent. 2004. "The History of the Greenhouse Effect." in *The Greenhouse Delusion*. 26.08.2022.
- Gürçam, Selçuk. 2021. "İklim Değişikliğiyle Mücadelenin Önündeki Barikat: Neoliberalizm." Pp. 109–26 in *Ekonomi, Yönetim ve Pazarlama Alanında Akademik Araştırmalar*, edited by Hasan Selçuk Eti. İstanbul: Karadeniz Kitap.
- Handl, Günther. 2012. "Declaration of the United Nations Conference on the Human Environment (Stockholm Declaration), 1972 and the Rio Declaration on Environment and Development, 1992." P. 11 in. United Nations Audiovisual Library of International Law.
- Hart, Benjamin, and David Wallace-Wells. 2022. "How Bad Is the Ukraine War for Climate Change?" *Intelligencer Is a Vox Media Network*. Retrieved (<https://nymag.com/intelligencer/2022/03/how-bad-is-the-ukraine-war-for-climate-change.html>).
- Harvey, Fiona. 2022. "This Article Is More than 1 Month Old Ukraine War Threatens Global Heating Goals, Warns UN Chief." *Guardian News & Media Limited or Its Affiliated Companies*. Retrieved (<https://www.theguardian.com/environment/2022/mar/21/ukraine-war-threatens-global-heating-goals-warns-un-chief>).
- Hashimoto, Koji. 2019. "Global Temperature and Atmospheric Carbon Dioxide Concentration." Pp. 5–17 in.
- Holden, Erling, Kristin Linnerud, and David Banister. 2014. "Sustainable Development: Our Common Future Revisited." *Global Environmental Change* 26:130–39. doi: 10.1016/j.gloenvcha.2014.04.006.



- Hulme, Mike. 2009. "On the Origin of 'the Greenhouse Effect': John Tyndall's 1859 Interrogation of Nature." *Weather* 64(5):121–23. doi: 10.1002/wea.386.
- IPCC. 1990. "FAR Climate Change: Scientific Assessment of Climate Change." Retrieved December 12, 2021 (<https://www.ipcc.ch/report/ar1/wg1/>).
- IPCC. 1995. *Climate Change 1995 The Science of Climate Change*.
- IPCC. 2001. *Climate Change 2001: The Scientific Basis*. New York.
- IPCC. 2007. *Climate Change 2007 Mitigation*.
- IPCC. 2013. *Climate Change 2013 The Physical Science Basis Working Group I Contribution to the Fifth Assessment Report of the Intergovernmental Panel on Climate Change*. Cambridge, United Kingdom and New York.
- IPCC. 2018. *2018: Summary for Policymakers. In: Global Warming of 1.5°C. An IPCC Special Report on the Impacts of Global Warming of 1.5°C*.
- IPCC. 2022a. *Climate Change 2022: Impacts, Adaptation and Vulnerability*.
- IPCC. 2022b. *Climate Change 2022 Mitigation of Climate Change*.
- Jackson, Roland. 2020. "Eunice Foote, John Tyndall and a Question of Priority." *Notes and Records: The Royal Society Journal of the History of Science* 74(1):105–18. doi: 10.1098/rsnr.2018.0066.
- Jones, Seth G., Catrina Doxsee, Brian Katz, Eric McQueen, and Joe Moye. 2021. *Russia's Corporate Soldiers The Global Expansion of Russia's Private Military Companies*. Lanham, Boulde, New York, London.
- Karavelioğlu, Feyza. 2009. "Körfez Savaşlarının Çevreye Etkisi." Ankara Üniversitesi.
- Keeble, Brian R. 1988. "The Brundtland Report: 'Our Common Future.'" *Medicine and War* 4(1):17–25. doi: 10.1080/07488008808408783.
- Kerker, Milton. 1961. "Science and the Steam Engine." *Technology and Culture* 2(4):381. doi: 10.2307/3100893.
- Khan, Nasir. 2022. "Ukraine Crisis: Effects of Russian Invasion on Climate Change." *One Tribe*. Retrieved (<https://onetribeglobal.com/climate-action-news/ukraine-crisis-effects-of-russian-invasion-on-climate-change/>).
- Kirby, Paul. 2022. "Why Has Russia Invaded Ukraine and What Does Putin Want?" *The BBC*. Retrieved (<https://www.bbc.com/news/world-europe-56720589>).
- Kuyper, Jonathan, Heike Schroeder, and Björn-Ola Linnér. 2018. "The Evolution of the UNFCCC." *Annual Review of Environment and Resources* 43(1):343–68. doi: 10.1146/annurev-environ-102017-030119.
- Library of Congress. 2022. "Germany: Amendment of Climate Change Act Codifies Climate Neutrality Goal by 2045." Retrieved (<https://www>).



loc.gov/item/global-legal-monitor/2021-09-28/germany-amendment-of-climate-change-act-codifies-climate-neutrality-goal-by-2045/).

- Liu, Jiping, Mirong Song, Radley M. Horton, and Yongyun Hu. 2013. "Reducing Spread in Climate Model Projections of a September Ice-Free Arctic." *Proceedings of the National Academy of Sciences* 110(31):12571–76. doi: 10.1073/pnas.1219716110.
- Maksym Chepeliev, Thomas Hertel, and Dominique van der Mensbrugge. 2022. "Cutting Russia's Fossil Fuel Exports: Short-Term Pain for Long-Term Gain." *VoxEU.Org*. Retrieved (<https://voxeu.org/article/cutting-russia-s-fossil-fuel-exports-short-term-pain-long-term-gain>).
- McCarthy, Joe. 2022. "How War Impacts Climate Change and the Environment." *Global Poverty Project*. Retrieved (<https://www.globalcitizen.org/en/content/how-war-impacts-the-environment-and-climate-change/>).
- McGrath, Matt. 2022. "Climate Change: 'Madness' to Turn to Fossil Fuels Because of Ukraine War." *BBC News Services*. Retrieved (<https://www.bbc.com/news/science-environment-60815547>).
- Meredith, Sam. 2022. "'The Situation Is Serious': Germany Plans to Fire up Coal Plants as Russia Throttles Gas Supplies." *CNBC*. Retrieved (<https://www.cnbc.com/2022/06/20/ukraine-war-germany-turns-to-coal-as-russia-throttles-gas-supplies.html>).
- Moazzem, Khondaker Golam. 2021. "Coal to Clean Power Transition: How Countries Responded at COP26." *The Daily Star*. Retrieved (<https://www.thedailystar.net/business/economy/news/coal-clean-power-transition-how-countries-responded-cop26-2224556>).
- Moron, Vincent. 2013. "Greenhouse Gases and Climatic Change." Pp. 31–46 in.
- Morrow, Sibel. 2022. "EU Commission Proposes Plan to Phase out Its Reliance on Russian Fossil Fuels." *Anadolu Agency*. Retrieved (<https://www.aa.com.tr/en/energy/oil/eu-commission-proposes-plan-to-phase-out-its-reliance-on-russian-fossil-fuels/34802>).
- Murray, William. 1994. "The Greenhouse Theory and Climate Change." Library of Parliament.
- Niranjan, Ajit. 2022. "Russia-Ukraine War Risks Greater Carbon Pollution despite Boost to Clean Energy." *DW Akademie*. Retrieved (<https://www.dw.com/en/ukraine-russia-climate-emissions-fossil-fuels/a-61130583>).
- Nummelin, Marjo. 2022. "EU Climate Policy." *Finnish Ministry of Environment*. Retrieved (<https://ym.fi/en/eu-climate-policy>).
- Paterson, Matthew. 2013. *Global Warming and Global Politics*. Routledge.
- Pereira, Paulo, Ferdo Bašić, Igor Bogunovic, and Damia Barcelo. 2022. "Russian-Ukrainian War Impacts the Total Environment." *Science of The Total Environment* 837:155865. doi: 10.1016/j.scitotenv.2022.155865.

- Peterman, Keith E. 2017. "Climate Change Literacy and Education: History and Project Overview." Pp. 1–14 in.
- Plass, Gilbert N. 1956. "The Carbon Dioxide Theory of Climatic Change." *Tellus* 8(2):140–54. doi: 10.1111/j.2153-3490.1956.tb01206.x.
- Rawtani, Deepak, Gunjan Gupta, Nitasha Khatri, Piyush K. Rao, and Chaudhery Mustansar Hussain. 2022. "Environmental Damages Due to War in Ukraine: A Perspective." *Science of The Total Environment* 157932. doi: 10.1016/j.scitotenv.2022.157932.
- Rayner, Tim, and Andrew Jordan. 2016. "Climate Change Policy in the European Union." in *Oxford Research Encyclopedia of Climate Science*. Oxford University Press.
- Reuters. 2022. "Oil Surges as U.S. Bans Russian Crude, Britain to Phase out Purchases." Retrieved (<https://www.reuters.com/business/oil-see-saws-near-14-yr-highs-us-weighs-russia-oil-embargo-2022-03-08/>).
- Rust, Susanne. 2022. "How Badly Will Russia's War Torpedo Hopes for Global Climate Cooperation?" *Los Angeles Time*. Retrieved (<https://www.latimes.com/world-nation/story/2022-03-07/russia-war-ukraine-global-action-climate-change-arctic>).
- Scherer, F. M. 1965. "Invention and Innovation in the Watt-Boulton Steam-Engine Venture." *Technology and Culture* 6(2):165. doi: 10.2307/3101072.
- Schipper, E. Lisa F. 2006. "Conceptual History of Adaptation in the UNFCCC Process." *Review of European Community and International Environmental Law* 15(1):82–92. doi: 10.1111/j.1467-9388.2006.00501.x.
- Sharma, Vigya. 2022. "Russia and Ukraine Are Important to the Renewables Transition. Here's What That Means for the Climate." *The Conversation*. Retrieved (<https://theconversation.com/russia-and-ukraine-are-important-to-the-renewables-transition-heres-what-that-means-for-the-climate-179079>).
- Snyder, Timothy. 2015. "Integration and Disintegration: Europe, Ukraine, and the World." *Slavic Review* 74(4):695–707. doi: 10.5612/slavicreview.74.4.695.
- Spring, Jake, Andrea Januta, and Gloria Dickie. 2022. "'Delay Means Death' - UN Climate Report Urges Immediate, Drastic Action." *Reuters*. Retrieved (<https://www.reuters.com/business/cop/delay-means-death-un-climate-report-urges-immediate-drastic-action-2022-02-28/>).
- Storbeck, Olaf, and David Sheppard. 2022. "Germany Fires up Coal Plants to Avert Gas Shortage as Russia Cuts Supply." *Financial Times*. Retrieved (<https://www.ft.com/content/f662a412-9ebc-473a-baca-22de5ff622e2>).
- Tollefson, Jeff. 2022. "What the War in Ukraine Means for Energy, Climate and Food." *Nature* 604(7905):232–33. doi: 10.1038/d41586-022-00969-9.
- Türkeş, Murat. 2001. "Küresel İklimin Korunması, İklim Değişikliği Çerçeve Sözleşmesi Ve Türkiye." *TMMOB Makina Mühendisleri Odası* (61):1–16.

- United Nations. 2019. "COP25: 'Signals of Hope' Multiplying in Face of Global Climate Crisis, Insists UN's Guterres." Retrieved (<https://news.un.org/en/story/2019/12/1052491>).
- United Nations. 2021a. "End of Coal in Sight at COP26." *Ukcop26.Org*. Retrieved (<https://ukcop26.org/end-of-coal-in-sight-at-cop26/>).
- United Nations. 2021b. "The Paris Agreement." *UN*. Retrieved (<https://www.un.org/en/climatechange/paris-agreement>).
- United Nations. 2021c. "What Is the Kyoto Protocol?" *UNFCCC*. Retrieved December 6, 2021 ([https://unfccc.int/kyoto\\_protocol](https://unfccc.int/kyoto_protocol)).
- United Nations. 2021d. "What Is the Paris Agreement?" *UNFCCC Sites and Platforms*. Retrieved (<https://unfccc.int/process-and-meetings/the-paris-agreement/the-paris-agreement>).
- United Nations. 2022. "Uniting the World to Tackle Climate Change." *Ukcop26.Org*. Retrieved (<https://ukcop26.org/>).
- Uprety, Dinesh Chandra, V. R. Reddy, and Jyostna Devi Mura. 2019. "Temperature Changes." Pp. 43–51 in *Climate Change and Agriculture*. Singapore: Springer Singapore.
- Wanat, Zosia. 2022. "Russia's War Is a Short-Term Win for Coal." *Politico*. Retrieved (<https://www.politico.eu/article/russias-war-is-a-short-term-win-for-coal/>).
- Weir, Doug. 2020. "New to Conflict and the Environment? We've Summarised the Main Ways That Wars and Militarism Harm the Environment." *Conflict and Environment Observatory*. Retrieved (<https://ceobs.org/how-does-war-damage-the-environment/>).
- WMO. 2009. *World Climate Conference-3*.
- Zhang, Rong, and Thomas R. Knutson. 2013. *The Role of Global Climate Change in the Extreme Low Summer Arctic Sea Ice Extent in 2012*.



“

## Chapter 10

**A NEW MODEL OF PUBLIC-PRIVATE  
PARTNERSHIP FOR DEVELOPING  
COUNTRIES**

*Özcan ERDOĞAN<sup>1\*</sup>*

”

---

<sup>1</sup> Özcan Erdoğan, Assist.Prof.Dr, Kütahya Dumlupınar University, ORCID ID:  
0000-0002-6737-3819

## 1. Introduction

In recent years, PPP(Public Private Partnership) has been utilized in various sectors, ranging from the development of infrastructure investments to the production and delivery of social services in many countries. The argument that the PPP model is an efficient way to use resources effectively and efficiently, improve the quality of services provided, and ensure development has played a significant role in this inclination. While PPP models are becoming increasingly prevalent in delivering public services such as education and healthcare, the boundaries between the public and private sectors have become uncertain. This uncertainty, which is closely related to the change in the roles and responsibilities assigned to the state, also serves as a tool for removing barriers to capital accumulation, privatizing public and communal spaces, and legitimizing their incorporation into the cycle of capital accumulation. Based on the thesis that the state has failed to provide services, shifting away from the approach government should stop providing public services and leave these areas to the private sector to the one that highlights the state's regulatory role and enables intervention when necessary has gained importance in recent years. The main factor driving this shift is the need for new areas of appreciation in order to ensure the expansion and reproduction of capital, as well as the development of conditions that will allow this process to be carried out with the least amount of risk (Buyruk, 2018).

Utilizing private capital and expertise in procuring public infrastructure and services is not a novel practice. Throughout the years, the collaboration between the public and private sectors in fields such as housing, economic development and revitalization, transportation, and municipal initiatives has yielded significant successes. Many governments are willing to build upon this success by expanding successful methods and developing new ones, all the way to providing good value for the money (Nisar, 2007).

Utilizing PPP effectively will increase the model's projected success and effectiveness.

## 2. Common characteristics of developing countries

In the past, a country's level of development was measured by the amount of steel and energy it produced; now, with the advancements in microelectronics, telecommunications, and computer technology that constitute the information technology sector, it is measured by the amount of information a country can obtain, process, transmit, and store (Cafri, 2018).

Services are crucial both domestically and internationally for the growing number of developing countries. As the economy improves, the

domestic supply of services varies in composition. Services fulfill a part of the basic needs of the population, contribute to the creation of jobs, and constitute part of the infrastructure. The significance of services utilized as inputs by other producer sectors increases as the level of development increases. The establishment of a services infrastructure increases the country's appeal and ability to absorb advanced technology; it also improves the potential to introduce innovation and competitiveness in the sector that produces goods.

Inequality gets worse, not better. While poor countries increase their population, rich countries increase their wealth. In the past year alone, the United States' growth in wealth was equivalent to the whole GDP of the African continent, excluding South Africa. Last year, the average British local's wealth increased by £27, which is more than half the average income in India (Pearse, 1970).

In a world economy that is not yet fully globalized, developing and underdeveloped governments, who are attempting to attract foreign investors and hot money to their countries and therefore care the most about information infrastructures, face a number of issues that require far more radical solutions in this field. The most important of these issues are structural problems related to these countries' economies. For these countries, the cost of new technologies is still quite high, which is the main cause of infrastructure problems. However, the results of public policies in developed countries that have created a universal service foundation with the public policies they have implemented over a long period and which are suggested to developing and underdeveloped countries with the claim of being successful also prevent these countries from fully benefiting from the advantages of information and communication technologies. The most important of these are the problems related to the fact that the regulation process itself and national and societal objectives which include the issues in the regulation process itself cannot be reflected in telecommunication policies.

When the characteristics of developing countries in recent history are reviewed, it is seen that structural problems are still prevalent.

### **3. R&D Expenditures**

Today, developed countries are prioritizing the production and application of information and technology in order to sustain economic growth. Labor, capital, and natural resources, which are conventional production elements, have become more effective, and their economic implications have grown with technological advancements. Moreover, the development in information and technology has gained importance not only to the economy but also to social life. Consequently, technology

policies are one of the primary areas of global competition. Research and development (R&D) activities are one of the most significant sources of technological and informational advancements. According to the OECD, research and development (R&D) activities are productive studies comprised of the knowledge and experience of the individual and society, conducted systematically to expand the accumulation of knowledge and to utilize the knowledge in the design of new applications. In this context, R&D expenditures continuously increase production capacity by developing new technologies and production methods (Saridoğan, 2019).

Recently, there has been a significant degree of interest in commercial research and development R&D, which is a type of intangible asset. The interest partially reflects the most recent widespread technological change, particularly the unexpected growth of science- and knowledge-based industries engaged in R&D. For instance, the value of the S&P 500 index at the end of 1999 was accounted for by the combined contributions of the pharmaceutical and technology sectors, which totaled roughly 40%. More equally astonishing is that the R&D expenditures of some of the largest technological industries exceed their profits. Finally, unlike several other types of intangible asset expenditure, U.S. (United States) accounting standards demand disclosure of R&D expenditures in financial statements (Chan et al., 2001).

According to calculations based on data from the central administration budget, 20 billion 249 million Turkish Lira were spent on R&D operations in 2021. This result indicates that the ratio of R&D expenditures made from the central government budget to GDP (Gross Domestic Product) was 0.28%, which was 7 trillion 209 billion TL. Moreover, 26 billion 307 million Turkish Lira were allocated from the central administration budget for R&D operations in 2022, according to expected results based on budget starting allocations (TURKSTAT, 2022).

As per GDP, EU research and development expenditure remained at 2.32 % in 2020, which was 2.23% in 2019. In 2020, the EU spent €311 billion on research and development, and the ratio of R&D to GDP was 1.97% in 2010. The business venture sector accounted for most research and development expenditure between 2010 and 2020, which climbed from 1.22% of GDP in 2010 to 1.53% in 2020, indicating an overall increase of 1.53%. (Eurostat, 2022).

R&D expenditures is one of the primary growth drivers in developed economies.

#### **4. The promotion of R&D Expenditures**

In Turkey, R&D activities have been incentivized in different years using a variety of incentive instruments or by increasing the ratio or



scope of current incentive instruments. A tax deferral application for R&D expenditure was introduced on January 1, 1986. The tax deferral incentive under Law No. 3239 began with the method of deferring the tax corresponding to this rate without interest for three years by foregoing the collection of 20% of the annual corporate tax that the taxpayers are required to pay in the relevant period, up to the number of their R&D expenditures during the year. While this opportunity was initially only available to corporate taxpayers, it was made possible for income taxpayers to take advantage of it as well owing to provisions in Article 89 of the Income Tax Law (Income Tax Law) No. 4369. In this application, the fact that it is indexed to the amount of corporate tax to be paid drives companies to engage in R&D. (that is, the corporate tax rate). It is clear that this practice will not have an incentive for the companies since there is no tax to be deferred within the legal period in years where there is no corporate tax base because the balance sheet of the period in the relevant year results in losses or exemption requests, or because there is no corporate tax to be paid by deducting the taxes previously paid from the calculated corporate tax for various reasons.

In light of the findings of the model's long-term analysis, where R&D expenditures are estimated to be the independent variable and GDP is the dependent variable, the GDP variable and the R&D expenditures variable in Turkey have a linear and significant association. It has been revealed that a 1% change in R&D expenditures results in a 0.85% increase in economic growth. This conclusion reinforces the general belief that technological advancements are the source of long-term growth and indicates that increasing R&D expenditure will have a favorable effect on economic growth. According to the results of the short-term analysis, the sign of the term coefficient for error correction is negative, statistically significant, and interpretable. In this scenario, it is possible to forecast that the differences between the series will disappear in three periods (Erdoğan, 2020).

The present study, which is focused on promoting R&D expenditures, revealed that there are long-term structural correlations between variables under structural breaks. The primary finding of long-term coefficient estimates is that technological innovation increases income inequality. The findings confirm the validity of the FKC (Financial Kuznets Curve) for the Turkish economy in the long term. In addition, the findings indicate that economic growth can reduce long-term income inequality. Causality analysis shows a twofold causality between financial development and income inequality in the long run. It also demonstrates that technological innovation and income inequality are mutually causative in the long run. Furthermore, long-term causality works from economic growth to income inequality (Çetin et al., 2021).

One of the components of economic progress is technological innovation or “innovation”. Innovation, brought by the entrepreneur to make a profit or reduce costs, implies a change in the existing production system and is a concept related to the main theme in Schumpeter’s theory of economic development. Economic development is a process of shifting economic equilibrium from lower points to higher points, and in the Schumpeter-style discourse of economic development, is a reason for such shifts. In cases of successful development, growth was combined with innovations such as developing production techniques and adopting new technologies in the brand state. Changes that are externally brought in or internally initiated lead to industrial restructuring by increasing productivity or growth. For this reason, economic development is a process of ongoing innovation (Lee, 2020).

Promotion of R&D expenditures also means the promotion of economic productivity.

### **5. Market Failure in R&D Studies**

The phenomenon known as market failure is the underlying reason for performing R&D at the required level. Moreover, market failure becomes the grounds for state intervention in the economy. In many nations, various incentives are provided for R&D investments in order to promote R&D activities. Tax incentives are the most important of these incentives. Indeed, tax incentives are the instruments frequently utilized by many nations, including our own (Can, 2021).

The high economic return of (R&D) and innovation activities, as well as their favorable contribution to accomplishing long-term growth objectives, these activities have become even more significant. In order to benefit from all these positive contributions of R&D and innovation activities, it is necessary to minimize the negative aspects that R&D activities face, such as high cost and excessive risk and uncertainty. Consequently, the state should establish incentive policies to overcome the private sector’s resistance to R&D activities caused by the mentioned limitations, and resources for R&D should be increased (Yücel, 2020).

The subject of the government’s proper involvement in the market is old and important. Public officials around the globe deal with this issue by determining which public services to provide or how to streamline the activities of individuals or businesses, as well as a more urgent task to privatize public obligations and recent efforts to “rediscover the state.” Increasingly, public officials have turned to the concept of market failure in pursuing objective goals through such decisions. The concept of market failure is frequently addressed in educational curricula and applied to state domains (Zerbe and McCurdy, 1999).

When examining the impact of governmental incentives on the degree and composition of R&D activities in the context of the Korean pharmaceutical industry, the following findings can be drawn: In general, the R&D incentive program promoted biotechnology start-ups and the overall private R&D of KPIA (Korean Research-based Pharmaceutical Industry Association) member firms. Moreover, the R&D incentive program encouraged biotechnology startups to broaden their R&D operations for new products. Consequently, it can be claimed that the Korean state R&D incentive program partially supports the below-optimal level of R&D investment by encouraging small startup companies to invest (Choi and Lee, 2017).

In R&D studies, it is evident that market failure must be completely eliminated.

## **6. Public-Private Partnership to Cover R&D Expenditures**

In 2002, the OECD Science and Technology Policy Committee defined PPP in the field of innovation as “any official relationship or agreement in which public and private actors work together in the decision-making process for a certain or indefinite period and invest together in limited resources such as money, personnel, devices, and information to achieve the objectives set in a particular field of science, technology, and innovation.” The objective of the PPP in the innovation sector is to enhance scientific and technological potential and establish a competitive sector for the functioning of local and international markets. As part of this collaboration, the state plays a key role in determining the “rules of the game” by constructing an institutional environment for the activities of all stakeholders. In addition, it fosters the generation of fundamental knowledge in research centres (public research centres, academies, universities) and offers the required database for the developed technology. On the other hand, the private sector concretizes scientific concepts and develops its own R&D-based technologies. From this aspect, the PPP model, which increases R&D efficiency, constitutes a critical element of a country’s innovation strategy. While the conventional PPP model is based on the principle of fixing public failures using private sector resources, the public-private innovation network symbolizes interaction and cooperation between public and private organizations in the production and distribution of information and innovation. This form of cooperation is also known as “innovation-oriented PPP,” “R&D partnerships,” and “public-private technology platforms” (Küçük, 2019).

There has been an exchange between public and higher education R&D expenditures in OECD countries during the 2000s, when private sector R&D expenditures increased. This can be explained by the fact

that the public develops research institutions as regulating and directing actors, private sectors and universities stimulate R&D activities with R&D supports, and the responsibility of commercialization of research outputs is assigned to the private sector. Indeed, as a result of market-oriented planning of investments through public R&D expenditures, the private sector has conducted more R&D; patenting trend and innovative activities have accelerated. In OECD member countries capable of achieving high innovation performance and efficiency, investments in information and communication technologies have been integrated with new business strategies, processes, and organizational structures, and the export share of advanced technology products has increased due to labor increases in productivity (Elik, 2020).

Worldwide, the most affected countries are, to a certain extent, Southern European countries and Ireland, and in particular, the new member states of Eastern Europe: they aimed for pre-crisis convergence based on S&T (Science and Technology) expenses. In this respect, the crisis is less likely to impact countries with strong state support for innovation activities prior to the crisis. In light of this, it would be intriguing to investigate further interconnections between the public and private sectors. Preferably, sustained government S&T budgets are more suitable to address the negative consequences of economic crises (Makkonen, 2013).

The relationship between technology transfer mechanisms utilized by federal laboratories and one of the government's scientific and technology objectives is a similar subject to the spread of technology in industries. The research question is the extent to which technology transfer mechanisms contribute to the spread of the technology of interest in society caused by the requested innovation. How companies with diverse characteristics, such as volume, industry, and stage of maturity, determine which technology transfer mechanisms to implement in order to collaborate with federal laboratories is another issue. These research questions are just a few examples of future work that is needed to address the gaps in this field (Tran and Kocaoglu, 2009).

Today, investing in R&D expenditures has become the top priority of the public sector.

## **7. Establishing the R&D Technological Infrastructure through PPP**

After the phenomenal success of this first technology development center, which was established in the United States in 1951 under the name "Stanford Industrial Park" and is known as "Silicon Valley" in our country, every country in the world attempted to implement this application by employing it as a model. Some countries have achieved their goals

by achieving successful results in these applications. This application, which emerged as a result of the commercialization of knowledge in the university world by transforming it into innovation and production, has evolved into R&D-based technology centers that produce innovation under different names but for the same purpose in both developed and developing countries worldwide (Eren, 2011).

The majority of our country's SMEs lack direct contact with research institutions. However, they can conduct their own R&D at universities across the country or at TUBITAK's research institutes. Given that R&D is expensive and necessitates a significant financial investment, it is evident that this approach is rational. It will not be possible to establish university-industry cooperation until our SMEs abandon their traditional practices and take advantage of the potential offered by science and technology in their own activities. In developed countries, however, this relationship is highly valued. In these countries, SMEs do their own R&D through universities and allocate a significant portion of their budgets to this effort (Görür, 2006).

In light of this, one may argue that STI PPPs are complementary measures in the overall STI (Science Technology Innovation) policy mix. Clearly, STI PPP has distinctive advantages for all partners to which it relates. However, STI PPPs should be viewed as horizontal policy instruments that necessitate preparation efforts, such as a systematic review and multiple players, because they combine a large number of embedded CSR policy tools. In the end, STIs are suited for both fundamental and applied research because to the diverse research cultures of their partners (Meissner, 2019).

Although the concept of public interest is uncontroversial, a realistic estimate of the cost of pharmaceutical R&D and, consequently, new drugs to determine the extent of the global health gap for the poor is still possible. Findings from the United States and other developed countries indicate that pharmaceutical R&D interests support favoritism the most. In order to arrive at a realistic cost of R&D, they fail to take into account a number of factors, such as changes in the new scientific research network and landscape, various mergers and industry gains, advancements in biotechnology, and the exploitation of local knowledge according to their biopharmaceutical content. In truth, pharmaceutical companies' R&D expenditures require serious questioning (Oguamanam, 2010).

Through PPPs, it appears probable to construct the technological infrastructure of R&D in both developed and developing countries.

## **8. Privatization of the Public Share in the Partnership Made with the PPP Method**

In a comparison of the concepts of PPP (Public Private Cooperation) and privatization, despite variations in ownership, transfer of responsibilities, and risk sharing, it is revealed that the two concepts essentially oppose one another in terms of the “cooperation” relationship. In PPP initiatives, there is no assumption that the state will withdraw from the market or fully limit its economic activities; rather, a long-term agreement process is established in which the state is the final accountable agent in the provision of public goods and services. With public-private partnership (PPP) projects, a synergistic environment is formed in which risks, responsibilities, and resources are shared, and mutual solidarity serves the objective of the efficient delivery of public goods and services. In privatization, since the public sector aims to withdraw fully from the market, it emerges as a result of the contraction of the state and the marketization of public services, and there is no concern for establishing a cooperative relationship (Palas Dağlı, 2020).

The dispersion of the legal infrastructure of PPP investments in Turkey, the expansion of its scope to include all investments requiring advanced technology or high financial resources, the lack of transparency of the contractual conditions that determine the risk and liability assumed by the public, the fact that contracts are subject to the provisions of private law, and the use of the BRT (Build Rent Transfer) method in health services in a manner that is not prevalent in the rest of the world are all issues that need to be addressed. (Batrel, 2017)

Certain stages of Public/private partnership attract attention. If a company could provide services at a lower cost and with a more efficient business model than universities usually do, it would seem reasonable to explore the possibility of forming partnerships with that company. In many campuses already, food services, car parking and even dormitories are supplied from outside, so why is this method not considered for the academic programs themselves? (Baines and Chiarelott, 2010).

In fulfilling the key role of local government, from the management’s point of view, exchange relations (treatments) between the public and private sectors occur on the following dimensions: the public sector regulates the transactions of the private sector; the public sector produces public goods with the help of the private sector; the public sector provides goods to the private sector for a fee; the public sector purchases goods produced in the private sector; the public and private sectors jointly produce goods; the private sector provides public goods; the private sector affects public regulations. All identified relationships result in the occurrence

of special treatment costs for the local government unit, and these costs should be accounted for at least when managing local government funding. (Poniatowicz, 2017).

If the form of the service allows, the privatization of public sector shares in PPPs is a process that should be accomplished without delay.

## **9. Discussion and Conclusion**

PPPs have become an indispensable institution for R&D studies that will bring advanced technology production. Advanced technology researches to be carried out by the private sector today require high R&D costs. These high R&D expenses limit the private sector's profitability and surpass its financing opportunities. However, the public sector also needs the dynamism of the private sector. Involvement of the public sector at this stage will expedite the completion of R&D studies that will result in improved technology for the private sector. Incorporating the public sector as a PPP partner will also increase the industry's scale size and scale efficiency. Consequently, once this procedure is completed, the price of products containing advanced technology will reduce. In this industry sector, PPPs will result in the successful execution of the "win-win" concept.

After applying the principles of "scale size" and "increasing return proportionate to scale" to the private sector using PPPs, it is now time to privatize this PPP or public share in the private sector. The public sector will no longer be involved in the private sector's R&D studies until a large-scale R&D study that will result in another advanced technology is conducted. With the PPPs model, the public sector will continue to contribute to the private sector, particularly in R&D studies related to advanced military projects, R&D studies related to space research, and R&D studies on a large scale related to the pharmaceutical industry.

During the stages of establishment, development, and privatization, PPPs will also assist in ensuring fair income distribution. Through PPPs, it is possible to achieve a rapid improvement in income distribution, particularly by increasing the current wage level in the economy. The participation of PPPs in R&D activities will contribute to the increase of GNP (Gross National Product) by increasing the production and export of high value-added products in the economy. The fact that PPPs also invest in education and technical education will contribute favorably to the improvement of the country's technological level and production quality and quantity. As we indicated in our article, it is crucial for our country to benefit from PPPs not only in the implementation of infrastructure investments, but also in the fields of R&D studies that lead to the development of advanced technology and manufacturing.



## REFERENCES

- Baines, L. and Chiarelott, L. (2010). Public/private partnerships: a Trojan horse for higher Education? *Journal of Computing in Higher Education, Vol.:* 22(3), pp. 153-161. doi: 10.1007/s12528-010-9035-2
- Başaran, F. (2004). Inflation society policies and developing countries(in Turkish), *Turkish Review of Communication Studies C.:* 2(2), pp. 7-31. doi: 10.1501/iltaras\_0000000029
- Batirel, Ö.F. (2017). Quality and public-private partnership in public infrastructure investments(in Turkish). *Journal of Life Economics, Vol.:* 4(2), pp. 1-8 doi: 10.15637/jlecon.196
- Buyruk, H. (2018, March). Public-Private Partnership in Education: Academy Schools in England(in Turkish), *Amme İdaresi Dergisi, C.:* 51(1), pp. 101-131.
- Cafri, R. (2018). The impact of the knowledge economy on growth, poverty, and income distribution in developed and developing countries(in Turkish), *Beyder , C.:* 13(1), pp. 21-35.
- Can, H. (2021). *Investigation and evaluation of tax incentives provided to research and development (R&D) activities in Turkey*(Unpublished Master Thesis) (in Turkish). Ankara University ,Institute of Social Sciences, Ankara.
- Chan, L. K., Lakonishok, J. and Sougiannis, T. (2001, December). The stock market valuation of research and development expenditures, *The Journal of Finance, Vol.:* 56(6), pp. 2431-2456. doi: 10.1111/0022-1082.00411
- Choi, J. and Lee, J. (2017). Repairing the R&D market failure: Public R&D subsidy and the composition of private R&D. *Research Policy, Vol.:* 46(8), pp. 1465-1478. doi: 10.1016/j.respol.2017.06.009
- Cetin, M., Demir, H. and Saygin, S. (2021). Financial development, technological innovation and income inequality: time series evidence from Turkey. *Social Indicators Research, Vol: 156(1)*, pp. 47-69. doi: 10.1007/s11205-021-02641-7
- Elik, T. (2020). *Public expenditures within the framework of national innovation and R&D policies: Turkey-OECD countries comparison*(Unpublished Master Thesis)(in Turkish). Manisa Celal Bayar University, Institute of Social Sciences, Manisa.
- Erdoğan, S. (2020). *The effect of R&D expenditures on macroeconomic variables*(Unpublished Master Thesis)(in Turkish). Adnan Menderes University, Institute of Social Sciences.
- Eren, M. (2011). *Technoparks and R&D support in Turkey's technological development*(Unpublished Master Thesis)(in Turkish). Marmara University, Institute of Social Sciences, Istanbul.



- Eurostat. (March 2022). *R&D expenditure*. Date of access: September 26 2022, [http://ec.europa.eu/eurostat/statistics-explained/index.php?title=R%26D\\_expenditure#:~:text=R%26D%20expenditure%20is%20a%20basic,four%20institutional%20sectors%20of%20performance](http://ec.europa.eu/eurostat/statistics-explained/index.php?title=R%26D_expenditure#:~:text=R%26D%20expenditure%20is%20a%20basic,four%20institutional%20sectors%20of%20performance).
- Görür, A. (2006). *R&D Management and R&D Activities in SMEs*(Unpublished Master Thesis)(in Turkish). Gebze Institute of Advanced Technology, Institute of Social Sciences, Gebze.
- Kutbay, H. and Öz, E. (2017). Comparison of Tax Incentives Implemented for R&D Activities in Turkey and Selected Countries(in Turkish), *Management and Economy, C.: 24*(3), pp. 783-802.doi: 10.18657/yonveek.346187
- Küçük, A. (2019, December). The importance of Public-Private Partnership (PPP) model in turkey's health R&D policy(in Turkish). *Turkish Studies-Social Sciences, Vol.: 14*(6), pp. 3211-3229.doi: 10.29228/TurkishStudies.39248
- Lee, Y-S. (2020, January). New general theory of economic development: innovative growth and distribution. *Review of Development Economics, Vol.: 24*(2), pp. 402-423. doi: 10.1111/rode.12654
- Makkonen, T. (2013, January). Government science and technology budgets in times of crisis. *Research Policy, Vol.: 42*(3), pp. 817-822.doi: 10.1016/j.respol.2012.10.002
- Meissner, D. (2015). Public-Private Partnership models for science, technology and innovation cooperation. *Journal of Knowledge Economy, Vol.: 10*(4), pp. 1341-1361.doi: 10.1007/s13132-015-0310-3
- Nisar, T.M. (2007). Risk management in Public-Private Partnership contracts, *Public Organization Review, (7)*, pp. 1-19. doi: 10.1007/s11115-006-0020-1
- Oguamanam, C. (2010). Patents and pharmaceutical R&D: Consolidating Private-Public Partnership approach to global public health crises. *The Journal of World Intellectual Property, Vol.: 13*(4), pp. 556-580. doi: 10.1111/j.1747-1796.2010.00396.x
- Palas Dağlı, E. (2020). Conceptual evaluation of the relationship between privatization and public-private partnership(in Turkish). *Dokuz Eylül University Journal of Law Faculty, Vol.: 22*(1), pp. 397-430. doi: 10.33717/deuhfd.715836
- Pearse, E. (1970, February). Aid to developing countries. *New Blackfriars, Vol.: 51*(97), pp. 78-83. doi: [doi.org/10.1111/j.1741-2005.1970.tb02031.x](https://doi.org/10.1111/j.1741-2005.1970.tb02031.x)
- Poniatowicz, M. (2017, September). Transaction costs in the context of the requirements of effective finance management for local government units. *Ekonomia I Prawo, Vol.: 16*(3), pp. 325-341.doi: 10.12775/EiP.2017.023
- Sarıdoğan, H.Ö. (2019, Aralık). R&D expenditure and economic growth: A case of EU28(in Turkish), *Journal of Management and Economic Research, C.: 17*(4), pp. 17-34.doi: dx.doi.org/10.11611/yead.545111

- Schultz, S. (1989). Developing countries and services, *Intereconomics*, Vol.: 24(5), pp. 227-233. doi: 10.1007/bf02928639
- Tran, T.A. and Kocaoglu, D.F. (2009, August 2-6). Literature review on technology transfer from government laboratories to industry. *Portland International Conference on Management of Engineering & Technology*, Portland, Oregon, USA, pp. 2772-2782. doi: 10.1109/picmet.2009.5261800
- TÜİK. (July 19, 2022). *Appropriations and expenditures allocated from the central government budget for R&D activities (in Turkish)*, 2022. Date of access: September 26 2022, <http://data.tuik.gov.tr/Bulten/Index?p=Merkezi-Yonetim-Butcesinden-Ar-Ge-Faaliyetleri-Icin-Ayrilan-Odenek-ve-Harcamalar-2022-45702#:~:text=Bütçe%20başlangıç%20ödenekleri%20esas%20alınarak,307%20milyon%20TL%20tahsis%20edildi>.
- Yücel, N. (2020). *The effect of tax incentives on R&D activities and innovation*(Unpublished Master Thesis)(in Turkish). Akdeniz University, Institute of Social Sciences, Antalya.
- Zerbe Jr., R.O. and McCurdy, H.E. (1999). The failure of market failure. *Journal of Policy Analysis and Management*, Vol.: 18(4), pp. 558-578. doi: 10.1002/(sici)1520-6688(199923)18:4<558::aid-pam2>3.0.co;2-u

“

## Chapter 11

### **A SHORT RETROSPECTIVE REVIEW ON THE THEORETICAL FRAMEWORK OF AGGLOMERATION ECONOMIES<sup>1</sup>**

*Oya KENT<sup>2</sup>*

”

---

1 This study is derived from the second chapter of the PhD dissertation entitled “Agglomeration Economies and the Geographic Concentration of Manufacturing Industries in Turkey” written by the author under supervision of Prof. Murat Donduran. PhD dissertation acceptance date: 28.09.2015 Yıldız Technical University Institute of Social Sciences.

2 Assistant Professor, İstanbul Okan University, Faculty of Business and Administrative Sciences, Department of Economics and Finance. E-mail: oya.kent@okan.edu.tr; ORCID ID: 0000-0003-0520-1840.

## 1. Introduction

In both developed and developing countries, it is observed that most economic activities are not uniformly distributed in space, but tend to cluster in certain locations. This observation brings into question the reasons and effects of agglomeration phenomenon which has been an issue of considerable interest both from policy and academic perspective. In this respect, understanding the major reasons behind uneven distribution of economic activity in different geographies has long been in the research agenda of social scientists.

Although agglomeration and industrial clustering phenomena have emerged as interesting research topics in the last three decades, discussion regarding the *location* of economic activity has a long history which dates back to 19th century starting with von Thünen, considered as the “founding God” (Samuelson, 1983, p. 1468) of economic geography and location theory, whose work has inspired urban and regional economics later on. Having had such an old history, it is not that straightforward to embed and present the *location* as a focus of analysis in a distinct and single theoretical framework. Indeed, the theoretical background of location choice phenomenon is related to a number of varied frameworks. Location theorists, economic geographers, regional scientists, urban economists, shortly researchers from several disciplines with different research traditions have employed a diverse set of theoretical frameworks and analytical approaches in examining agglomeration of economic activity. However, Krugman (1991a) has been the researcher clarifying the microeconomic underpinnings of both spatial economic agglomerations and regional imbalances at national and international levels within a full-fledged general equilibrium framework. The seminal work of Krugman (1991a) has brought forth the field called New Economic Geography (NEG) and stimulated a new way of theorizing. The contribution of NEG is crucial in bringing back the notion of location to the core of economics by using the tools of mainstream economics.

This study provides a short and non-technical overview of the locational analysis in order to enlighten the path to the emergence of NEG which has brought back the *location* to the core of economics. This perspective presents one a comprehension on how origins and the historical discussions of the location theory combined with the developments in economic theory and interactions with urban and regional economics evolves into the emergence of New Economic Geography. First, section 2 presents a pretty brief overview of the treatment of location in economic analysis historically from von Thünen to new trade theory from which the NEG gets off the ground. Then,

section 3 shifts the interest from theoretical discussions to potential sources of agglomeration that are agreed upon in the literature by introducing reasons behind the tendency of economic activities to concentrate. Finally, section 4 concludes.

## **2. Overview: The Path to New Economic Geography**

In order to understand how analysis of location has been integrated into economic theory by 1990's, it is essential to shed light on the relationship between economic geography and other disciplines such as international economics, urban and regional economics and location theory. The way how it is related lies behind the definition of economic agglomeration or concentration in geographical space. Agglomeration of economic activities may arise at many geographical levels, as Fujita and Krugman (2004, p. 140) puts:

*“For example, one type of agglomeration arises when small shops and restaurants are clustered in a neighborhood. Other types of agglomeration can be found in the formation of cities, all having different sizes, ranging from New York to Little Rock; in the emergence of a variety of industrial districts; or in the existence of strong regional disparities within the same country. At the other extreme of the spectrum lies the core-periphery structure of the global economy corresponding to the North-South dualism”*

Spatial unit of reference or *spatial scale* distinguishes those various types of agglomerations, nonetheless whichever scale is executed, “the emergence of economic agglomeration is naturally associated with the emergence of inequalities across locations, regions or nations” (Fujita and Thisse, 2009, p. 109). From this point of view, it is not so hard to establish a link between economic geography and urban, regional and international economics.

The following section outlines the development of analysis of location or space within different but related disciplines in a historical context. Section 2.2 points to the essential links between international economics, more precisely international trade and economic geography.

### **2.1. Locational Analysis in Retrospect**

The location, as a non-negligible factor of economic activity, has long remained outside the economic analysis. Certainly, it is not because economists find economic geography, which studies where economic activity takes place and why, uninteresting or unimportant. In fact, it has always been important, but due to the fact that they have regarded it as technically intractable, it has been neglected until the emergence of NEG in early 1990's. NEG, by exploiting the new tools developed in the field of industrial organization in mid-1970's and

been captivated by the increasing returns revolution, has succeeded to explain why, how and when the economic activity may be concentrated only in a few locations in a full-fledged general equilibrium framework (Fujita, Krugman, and Venables, 2001).

Without doubt, NEG did not discover *space* as an integral part of economic analysis out of nothing. The history of spatial analysis is very deep and rich such that its roots go back to the beginning of 19th century. Within the framework of *general location theory*<sup>1</sup>, von Thünen is regarded as the “founding God” (Samuelson, 1983, p. 1468) of economic geography and location theory. Following his monumental work, “a variety of pioneering ideas have been developed periodically by great location theorists, geographers and economists such as Launhardt (1885), Marshall (1890), Weber (1909), Hotelling (1929), Ohlin (1933), Christaller (1933), Palander (1935), Kaldor (1935), Hoover (1936, 1937), Lösch (1940) and Isard (1949)” (as cited in Fujita (2010, p. 2)). And, in the second half of the 20th century, interest of researchers in the subject increased giving way to the development of regional science in 1950’s, urban economics in 1960’s and NEG in 1990’s (Fujita and Krugman, 2004).

Given the enormous magnitude of literature on spatial economics accumulated within two hundred years and being addressed by different fields, it is quite a hard task to survey the bulk of the literature here. But, since “the historic book *The Isolated State* (1826), by von Thünen, signified the birth of spatial economics” Fujita (2010, p. 3) and the question of “how the economy organizes its use of space” redirects one to consider models pioneered by von Thünen in the early 19th century, it’s worth mentioning its keystones in a nutshell.

von Thünen (1826) presumed an “isolated state” where a very large town is located at the center supplied by farmers in the surrounding countryside. It is assumed that crops differ in terms of yield and transportation costs and allowed for the possibility that each crop could be produced with different intensities of cultivation. Based on this, he asks two main questions: how to allocate land around the town to minimize the combined cost of transportation and production and how will the land be allocated in case of competition between self-interested farmers and landowners. Then, he showed that land rents declines from

---

1 Fujita (2010) considers *general location theory* as the most fundamental theory of spatial economics and denotes NEG as representing the newest wave in the development of general location theory. What he refers as *spatial economy* is a broad term which should encompass all branches of economics dealing with the analysis of economic processes and developments in geographical space. In this respect, any field of economics dealing with space, for instance urban economics, regional economics, international trade, are counted within the realm of spatial economics.

a maximum at the town to zero at the outermost limit of cultivation due to competition among the farmers. There is a trade-off between land rents and transport costs faced by each farmer. Since transport costs and yield differ among crops, a pattern of concentric rings of production emerges (Fujita, 2010).

Fujita, Krugman, and Venables (2001) and Fujita (2010) appraise von Thünen's model as ingenious and quite deep analysis of spatial economy despite it seems simple and obvious. According to Samuelson (1983, p. 1468) von Thünen "not only created *marginalism* and *managerial economics*, but also elaborated one of the first models of *general equilibrium* and did so in terms of realistic *econometric parameters*". He adds that "Modern geographers claim Thünen. That is their right. But economists like me, who are not all that taken with location theory, hail Thünen as more than a location theorist. His theory is a theory of general equilibrium" (Samuelson, 1983, p. 1482). And as a spatial economist Fujita (2010, p.3) claims that "Thünen's theory is a theory of general equilibrium in space, or for short, a general location theory"<sup>2</sup>.

With the increasing economic importance of manufacturing over the second half of the 19th century, location of industry gained a renewed interest from economists. Following the seminal work of von Thünen, industrial location theory has advanced significantly in the first half of the 20th century, especially with the contributions of German scholars. Preliminary formal analysis of industrial location in late 19th and early 20th century were presented in a partial equilibrium framework where location of plants, markets, producers and prices were taken as given. Launhardt's (1885) analysis is considered among the first of these where market area analysis and spatial price policy is studied. Another important work which later influenced development of industrial location theory is Weber's (1909) analysis which considers optimal location of the plant that minimizes the total transport cost per unit output. Besides being a pioneering theory of industrial location, his theory was deprived of price analysis and market structure which means that prices of inputs and outputs were not determined endogenously, and due to this fact, his industrial location theory was not sufficiently appreciated by economists (as cited in Fujita, 2010). It is also possible to evaluate this as an historical constraint on economic modelling in the sense that at that time neither the non-competitive theory of markets nor game theoretic approach to interactive behavior was well-developed. Therewithal, there has been an important contribution to the field outside the continental Europe in late 19th century.

---

2 For further discussion on von Thünen's model, the reader may refer to the mentioned articles.

In England, Marshall (1890) presented his famous study *Principles of Economics* in which he devoted a chapter on industrial agglomeration where he examined systematically the reasons behind the concentration of specialized industries in particular locations. Marshall stressed the importance of externalities, in the formation of economic agglomerations which have been revisited by urban economics and NEG almost a hundred years later. Marshallian externalities will be discussed more in detail in the next section.

Meanwhile, during 1920's and 1930's non-competitive theory of firms had been developed by leading scholars such as Hotelling (1929), Chamberlin (1933), Robinson (1933) (as cited in Fujita, 2010) and Kaldor (1935), which have been the precursors of new industrial organization theory based on non- competitive behavior of firms in 1970's. But before that, non-competitive models have been applied to industrial location theory by German scholars, notably Christaller (1933) and Lösch (1940) which have been very influential thoughts in location theory<sup>3</sup>. The main question considered was how economies of scale and transport costs interact to produce a spatial economy. However, Fujita, Krugman, and Venables (2001) argue that these models are rather a description at best than an explanation of the economy's spatial structure due to the fact that they lack a sound economic modelling in which one finds an explanation on how a phenomenon emerges from the interaction of decisions by individuals. In their own words, "Lösch showed that a hexagonal lattice is efficient; he did not describe a decentralized process from which it might emerge. Christaller suggested the plausibility of a hierarchical structure; he gave no account of how individual actions would produce such a hierarchy (or even sustain one once it had been somehow created)" (Fujita, Krugman, and Venables, 2001, p. 27).

In the meantime, although spatial dimension of economic activity has been neglected by mainstream economics, some of the scholars have started to discuss the role of space on the distribution of economic activities from an alternative standpoint. The necessity for a general theory of location and space-economy that is fundamentally different from neoclassical general equilibrium framework based on perfect competition has been supported by Kaldor, Lösch, Isard, Koopmans and several others (Fujita, 2010). In the first place, Isard (1949) has offered powerful insights to why competitive equilibrium paradigm could not be the right foundation for the space-economy and proposed general theory of monopolistic competition as the alternative. This insight has first been presented in a theoretical framework by Koopmans and Beckmann (1957) suggesting that competitive pricing

---

3 For a detailed discussion on *central place theory* the reader may refer to Fujita, Krugman, and Venables (2001) and Fujita (2010).



and positive transport costs are incompatible in a homogeneous spatial economy. Then, a definitive answer has been given by Starrett (1978) to competitive paradigm by extending it to a general equilibrium framework<sup>4</sup>. The work of Starrett has clearly shown the inability of competitive models to explain the endogenous formation of economic agglomeration<sup>5</sup>. Thus, Fujita (2010, p. 19) states that if one wants to get insights “about the spatial distribution of economic activities, in particular the formation of major economic agglomerations as well as regional specialization and trade, we must make at least one of the following three assumptions: (i) space is heterogeneous, (ii) externalities in production and consumption exist, or (iii) markets are imperfectly competitive”. Based on these three assumptions, he classifies three modelling strategies which represent different agglomerative forces shaping economic space:

**A. Comparative advantage models:** These models focus on the economic outcomes of heterogeneity of space that introduces uneven distribution of immobile resources (mineral deposits, natural harbors, some production factors), amenities (climate) as well as the existence of transport nodes (transshipment points, ports). Under constant returns to scale and perfect competition, these heterogeneities generate comparative advantages among locations which in turn give rise to interregional or intercity specialization and trade (Fujita, 2010). Class A encompasses models such as monocentric city models of urban economics where central business districts arise and the Heckscher-Ohlin theory in which different endowments of production factors lead to international trade and specialization (Fujita and Thisse, 2009).

**B. Externality models:** Basic forces for spatial agglomeration and trade are generated endogenously through non-market interactions among firms in these models, unlike comparative advantage models. Non-market interactions yield increasing returns external to a firm, such as knowledge spillovers, business communications, social interactions etc. However, this approach still allows one to appeal to constant returns/perfect competition paradigm (Fujita, 2010). Moreover, “traditionally externalities have been treated in a “black box” manner that tends to hide the actual micro-interactions giving rise to such externalities” (Fujita and Thisse, 2009, p. 111). These models are mainly developed within the realm of urban economics.

---

4 For an extensive theoretical modelling and discussion of competitive paradigm debate see chapter 2 in Fujita and Thisse (2002)

5 Fujita and Thisse (2002) entitle this result Spatial Impossibility Theorem. It “implies that when space is homogeneous and transportation is costly, the only possible competitive equilibrium is the so-called backyard capitalism in which every location operates as an autarky. In turn, this is possible only when production activities are perfectly divisible. This clearly shows the limits of the competitive paradigm for studying the main features of actual spatial economies” (Fujita, 2010, p. 19).

**C. Imperfect competition models:** In these models, firms are no longer treated as price takers, rather their pricing policies depend on the spatial distribution of consumers and firms. Then, in turn some form of interdependencies arises between the location choices made by firms and households. Fujita (2010) further distinguishes these models by their approach to market competition as:

– **(C1) Monopolistic competition models:** Firms are able to set their own prices and produce differentiated products under increasing returns to scale condition, unlike in competitive models. However, although they are price setters, strategic interaction among firms is not allowed since there are many. The models in this class are extensively developed in NEG framework.

– **(C2) Oligopolistic competition models:** These models assume existence of a few large agents (firms, land developers, etc.) that strategically interact with each other by considering their market power. They take place within the realm of game theory and exemplified by spatial competition models in which a small number of firms compete for dispersed consumers (Fujita and Thisse, 2009). “Due to technical difficulties, most of the class C2 models developed so far are partial equilibrium models, leaving the advancement of class C2 general location models mostly for the future”(Fujita, 2010, p. 20).

It is interesting to note that the classification made by Fujita (2010) also follows a chronological order as well as reflecting the developments in modelling strategies. Group A models comprise traditional models of international trade in which location of economic activity is exogenously determined by differences in factor endowments and early urban economics models in 1960’s where monocentricity of a city is a priori assumed. Due to the need for more general theory of urban locations, general local models of urban morphology have started to develop in early 1970’s which sought to explain the geographical distribution of all agents in a given urban area without making a priori assumption about any center. And in line with the developments in industrial organization theory in late 1970, monopolistic competition models of class C1 has arisen beginning in late 1980’s in urban economics and early 1990’s in NEG (Fujita, 2010).

## 2.2. International Trade and Economic Geography

International economics might be expected to be treated as a special case of economic geography in which borders and the actions of governments play a crucial role in shaping the location of production. However, the analysis of international trade has not made use of insights from neither economic geography nor location theory. Traditional trade theory has treated countries as dimensionless points within which factors

of production move instantly and without any cost from one activity to another, and moreover trade among countries takes place in a space-less platform where transportation costs are zero for all traded goods (Krugman, 1991b).

By the mid 1970's, trade theory was based on the notion of comparative advantage which would result either due to technological differences (Ricardian models) or differences in factor endowments (Heckscher-Ohlin models). Countries were assumed to trade with each other over the goods in which they have comparative advantage. With this notion, it makes vague predictions for the location of economic activity in the sense that allowing for each location to specialize in the production of goods with comparative advantage. This would also hint on the idea that trade would take place between dissimilar countries in dissimilar goods. In fact, comparative advantage has explained clearly what was going on until that time. After World War II, especially after the major trade agreements of the 1950s and 1960s, the more puzzling trade patterns emerged, which Krugman (2009) calls this new phenomenon similar-similar trade. He shows evidence on the change in trade patterns by displaying the composition of British trade circa 1910 and in the 1990's. Britain, as a capital abundant country with scarce land, used to export manufactured goods and import raw materials on the eve of World War I, and "the pattern of trade made perfect sense in terms of classical comparative advantage" (Krugman, 2009, p. 562). However, the situation in terms of trade patterns was not as easy as has been to explain by traditional trade theories where Britain exported and imported mainly manufactured goods in 1990's. Moreover, trade that has been restructured after World War II, has started to place between similar countries.

In fact, the case of similar-similar trade was not so incomprehensible as Balassa (1966) has given the directions of intra-industry trade in Europe as follows: each country would produce only some part of the potential products it could produce within each industry importing those goods it did not produce because specialization in narrower ranges of machinery and intermediate products will permit the exploitation of economies of scale through the lengthening of production runs" (as cited in Krugman (2009, p. 562)). Even though these ideas were not unrealized or rejected on the ground of being incomprehensible, they had been ignored because they were associated with unexhausted economies of scale at the firm level which had a direct implication of imperfect competition. And at that time, there were not readily available general equilibrium models of imperfect competition where "trade theory, perhaps more than any other applied field of economics, is built around general equilibrium analysis"(Krugman, 2009, p. 563).

So, from Ricardo until the 1980s, the question of why there was a special emphasis on comparative advantage rather than increasing returns in explaining trade clarifies with the fact that comparative advantage could be modelled using models that assumed constant returns and competition, which were the tools at hand (Krugman, 1991b). In the meantime, mid-1970's witnessed a "new wave of theory in industrial organization which provided the economics profession with a menu of models of imperfect competition" (Krugman, 1991b, p. 6). The monopolistic competition models in the presence of increasing returns developed in the field of industrial organization, in particular the model developed by Dixit and Stiglitz (1977), has been applied to many fields in economics. The so-called *increasing returns revolution* first has been influential in international trade theory by the end of 1970's, and a few years later growth theorists applied the tool-box to economic growth theory where sustained growth arose from the presence of increasing returns. These two fields are widely known as "new trade theory" and "new growth theory" which Krugman (1998) calls the second and third wave of increasing returns revolution, and later the "new economic geography" will be named as the fourth<sup>6</sup>.

Monopolistic competition models explored within the line of new trade theory provided a context for international trade that completely bypassed the conventional arguments based on comparative advantage. This context has been able to give way to trade between countries that were identical in resources and technology where they specialize in producing different products due to consumers' love of variety. Moreover, they were able to provide explanation for similar-similar trade where "similar countries had little comparative advantage with respect to each other, so their trade was dominated by intra-industry trade caused by economies of scale" (Krugman, 2009, p. 564).

The main purpose here is far from surveying the existing literature on new trade theory, nor present its theoretical background which definitely is another research topic. Yet, it is important to bring into view what new trade theory came along with. Krugman (1979) with his path-breaking work not only clearly articulated this new revolutionary approach for international trade theory, but also planted the seeds of new economic geography where location of economic activity can be analyzed within the framework of a general-equilibrium model (Committee, 2008).

In Krugman's (1979) approach, economies of scale that are internal to the firm lies in the core which amounts to that firms are able to

---

<sup>6</sup> The seminal and major articles related to new trade theory and new growth theory may be referred as Krugman (1979, 1980, 1981) and Romer (1986, 1987, 1990), respectively.

reduce their average costs by expanding production. The simple model in a closed economy setting produces a result such that the larger the economy the more variety of goods are produced which is the channel through which increasing returns operate. Due to consumers' taste for variety in the model, the consumers benefit from higher production in terms of increasing variety where firms exploit economies of scale by producing more. Then, one is able to compare "autarky" situation where there is no trade with the case of trade taking place between two countries. Assuming that countries have identical tastes and technologies (and factor endowment differences are ruled out by one-factor model), when trade takes place between two economies at zero transportation cost, both the scale of production and the range of goods available for consumption will increase<sup>7</sup>. So, welfare in both countries will increase, both due to higher real wages and increased choice. With this analysis he shows that economies of scale may give rise to trade and gains from trade even in the absence of differences in tastes, technology, or factor endowments. However, the direction of trade is indeterminate in this model, that's to say which country exports which goods is not known, it can only be said that each good will be produced in only one country (Krugman, 1979).

Building on Krugman's approach, an extensive literature has developed in this field exploring the implications of increasing returns and monopolistic competition on international trade. However, one of the important contributions has come from Krugman (1980) where he extended his 1979 model by incorporating *transportation costs* and *home market effect* into it. There has been a significant decline in transportation costs during 19th century which contributed largely to the growth of trade and it was not accounted for in trade models till then. Including transportation costs, then allowed for adapting home market effect into trade models analytically. Home market effect basically arises when transport costs are explicitly considered, imperfectly competitive industries tend to concentrate their production in their larger markets and to export to smaller ones (Ottaviano and Thisse, 2004). Krugman (2009, p. 565) explains the basic intuition behind transportation costs and home market effect as follows:

*"Increasing returns provide an incentive to concentrate production of any one product in a single location; given this incentive to concentrate, transport costs are minimized by choosing a location close to the largest market, and this location then exports to other markets".*

---

<sup>7</sup> Due to the symmetry in two economies, wage rates will be equal and the price of any good produced in either country will be the same

While the work of Krugman (1979, 1980) had an immediate impact on the trade literature and provoked further research, it would take more than ten years for his approach to have an important influence on the economic geography literature which will be mentioned in the following sections<sup>8</sup>. He explains in his own words how his interest evolved from international economics to economic geography as follows:

*“As I explained in Krugman (1991), I initially thought that some interesting things about the increasing factor mobility might be said from my own perspective on international trade. As I worked on the subject, however, I found that my analysis was drifting further and further away from international economics as I knew it. In international economics, we take as our base case a world in which resources are completely immobile but in which goods can be costlessly traded. What I found myself gravitating towards was a style of model in which factors of production were perfectly mobile but in which there were costs to transporting goods. In other words, I found myself doing something closer to classical location theory than to international trade theory.”*(Fujita and Krugman, 2004, p. 151).

### **3. Sources of Agglomeration**

As mentioned in the previous section, agglomeration phenomenon has been in the research agenda of many scholars from different disciplines for a long time. The common purpose of these disciplines may be stated as the effort they pay to understand the reasons behind the tendency of economic activities to agglomerate. Although they differ in terms of their theoretical frameworks and the way they approach to the subject, clustering phenomenon eventually derives from internal or external economies of scale (Karlsson, 2008). From this point view, one may present generally accepted sources of agglomeration as natural advantages, externalities, internal increasing returns and transportation costs.

#### **3.1. Natural Advantages**

Natural advantages refer to exogenously given characteristics of different locations, such as climatic conditions, availability of raw materials, proximity to natural harbors, etc. Prior to industrialization process, the distribution of economic activity has been determined by the distribution of land available for agricultural production (Kim, 1999). Besides emphasizing the importance of externalities, Marshall (1890) has also identified natural advantages as one of the main causes of geographic concentration of production.

---

<sup>8</sup> The final section of Krugman (1979) on migration and agglomeration and incorporation of transportation costs and home market effect in Krugman (1980) basically form the nucleus of, which later will be called, NEG.



*“Many various causes have led to the localization of industries; but the chief causes have been physical conditions; such as the character of the climate and the soil, the existence of mines and quarries in the neighborhood, or within easy access by land or water. Thus, metallic industries have generally been either near mines or in places where fuel was cheap. The iron industries in England first sought those districts in which charcoal was plentiful, and afterwards they went to neighborhood of collieries. Staffordshire makes many kinds of pottery, all the materials of which are imported from a long distance; but she has cheap coal and excellent clay for making the heavy saggars or boxes in which the pottery is placed while being fired. Straw plaiting has its chief home in Bedfordshire, where straw has just the right proportion of silex to give strength without brittleness; and Buckinghamshire beeches have afforded the material for the Wycombe chair making. The Sheffield cutlery trade is due chiefly to the excellent grit of which its grindstones are made”*(Marshall, 1890, p. 268-269)

Also known as ‘first nature’, as dubbed by Krugman (1993), is certainly “important to explain the location of heavy industries during the Industrial Revolution, because the proximity of raw materials was a critical factor” (Ottaviano and Thisse, 2004, p. 2565). However, it fails to provide reasonable explanation for other forms of agglomeration, for instance Silicon Valley type, which have nothing to do with natural advantages. Nevertheless, Ellison and Glaeser (1997) state that even if natural advantages as a reason for geographic concentration may not seem exciting, still it explains some of the observed agglomerations, for instance importance of climate for wine industry, proximity to coasts for shipbuilding industry etc. Although they don’t differentiate between natural advantages and spillovers in their 1997 model, they consider only natural cost advantages as a reason for agglomeration in Ellison and Glaeser (1999) and conclude that 20 per cent of measured geographic concentration in U.S. can be attributed to a few observable natural advantages. Kim (1999) also attempts to differentiate between natural advantages and spillovers causing geographic concentration by controlling for factor endowments and shows that factor endowments explain a large amount of the geographic variation in U.S. manufacturing over time. These studies show that, although natural advantages are not solely capable of capturing the incentives behind agglomeration, they do account for some clustering behavior and better not to neglect them by deeming as obsolete.

### **3.2. Externalities**

Theories of agglomeration have extensively utilized the notion of scale economies as principal factors explaining the spatial agglomeration of firms. Internal economies of scale are associated with

production conditions of a single firm, while external economies are independent of a single firm but accrue to all firms located in the same area. Internal increasing returns are placed at the core of NEG which will be discussed in the next section. On the other hand, external economies generally have been used in modelling agglomeration by urban economists, regional scientists, geographers and even by management scholars. Before going deeper, it is important to remark that external economies, or shortly *externalities*, are pure in the sense that which are external to an individual firm but internal to the industry. Externalities handled by this manner allows one to work within the realm of perfect competition providing a convenient framework for modelling. Furthermore, external economy models, if appropriately designed, are able to yield same agglomeration outcomes as monopolistic competition models. However, the shortcoming of these models arises as the vague description of the sources of external economies which in turn leads the spatial extent to be determined exogenously in an ad hoc manner (Fujita and Krugman, 2004).

Setting theoretical modelling discussion aside, the contribution of the concept of external economies in the form of localization economies is attributed to Marshall (1890) where identified three distinct reasons for localization: *labor market pooling*, *input sharing* and *knowledge spillovers*.

*Labor market pooling*: First, concentration of a number of firms in an industry in same location allows workers a pooled market with specialized skills which benefits both workers and firms:

*“When an industry has thus chosen a location for itself, it is likely to stay there long; so great are the advantages which people following the same skilled trade get from near neighborhood to one another...A localized industry gains a great advantage from the fact that it offers a constant market for skill... Employers are apt to resort to any place where they are likely to find a good choice of workers with the special skill which they require; while men seeking employment naturally go to places where there are many employers who need such skill as theirs and where therefore it is likely to find a good market. The owner of an isolated factory, even if he has good access to a plentiful supply of general labor, is often put to great shifts for want of some special skilled labor; and a skilled workman, when thrown out of employment in it, has no easy refuge.”*(Marshall, 1890, p. 270)

This agglomerative force defined by Marshall (1890) is known as *labor market pooling*. Krugman (1991b) clarifies the nature of the gains from labor market pooling with a trivial example. Assume that there are two locations and only two firms in an industry, each of which can produce



in either of only two locations. They use the same distinctive kind of skilled labor in their production, however their demands for labor are not perfectly correlated for some reason, may be due to producing differentiated products that face uncertain demand or being subject to firm specific production shocks. In the end firms' demand for labor is imperfectly correlated and uncertain. For the sake of concreteness, now think that each firm face both good and bad economic conditions during their production where in the former case they employ more and, in the latter, less of specialized workers. Suppose that it employs 125 workers in good and 75 workers in bad conditions, also assume that there 200 workers with these specialized skills thus average demand for labor equals supply. At this point, the crucial question arises as: Will both firms and workers be better off if two firms choose different locations each forming a company town with a local labor force of 100 workers or if they choose the same location with a pooled labor force of 200 workers that can work in either firm? When we consider the case from firms' point of view, they will be better off by locating in the same location, such that they will be able to hire more during good conditions taking advantage of the pooled labor. Otherwise, if they had located separately, they would have had to content with the existing local labor force which does not suffice to meet labor demand in good times resulting in an excess demand for labor. If both firms located in the same location, however, then at least occasionally one firm's good conditions would coincide with other's bad conditions and additional workers would be available. Considering the case from workers' side gives the same result as in good times they have more opportunity to be employed especially when one firm's bad conditions will be offset by the other firm's good conditions.

Krugman (1991b) argues that uncertainty alone would not suffice to generate localization. In the previous example it was a necessary condition for each firm to locate in only one location to take advantage of labor market pooling. However, if divisibility is assumed in production, such that each firm would split into two identical firms, then the same pattern would be replicated in both locations and the motivation for localization would be gone. So, in order to make the assumption that both firms choose the same location, at least some form of indivisibilities should exist in production. If there are sufficient economies of scale in production, a single production site emerges. In this sense, he fills the gap in Marshall's labor pooling argument by emphasizing the role of increasing returns. Yet, he claims that this is not a description of the process that might bring about concentration, rather only an argument for the advantage of concentrated production.

Following that, he formalizes the labor market pooling argument with the help of a phase diagram in which horizontal axis shows the West's share of workers, vertical axis shows West's share of firms and two curves depicting which distributions of firms and workers will leave the typical firm and worker respectively indifferent between the two locations<sup>9</sup>. With this rough formalization he shows that three equilibria emerge, one of which is knife-edge unstable. Depending on the initial conditions there arise a converge towards concentration of both firms and workers either in East or West.

*Input sharing:* The second Marshallian force for agglomeration is the provision of non-traded inputs specific to an industry in greater variety and at lower cost. As Marshall (1890) verbalizes:

*“Subsidiary trades grow up in the neighborhood, supplying it with implements and materials, organizing its traffic, and in many ways conducing to the economy of its material...the economic use of expensive machinery can sometimes be attained in a very high degree in a district in which there is a large aggregate production of the same kind, even though no individual capital employed in the trade be very large. For subsidiary industries devoting themselves each to one small branch of the process of production, and working it for a great many of their neighbors, are able to keep in constant use machinery of the most highly specialized character, and to make it pay its expenses...”*(Marshall, 1890, p. 270)

The advantage of input sharing is straightforward such that “a localized industry can support more specialized local suppliers, which in turn makes that industry more efficient and reinforces the localization” Krugman (1991b, p. 49). The notion of input sharing also crucially depends on the existence of scale economies in input production. In the absence of scale economies in input production even a small scale of production would be as efficient as a large one. A large center of production is able to have more efficient and more diverse suppliers than a small one only in the presence of increasing returns (Krugman, 1991b).

Similar to the example in labor pooling argument, Krugman (1991b) provides a trivial example to illustrate how input sharing stimulates agglomeration. Assume that there is a variety of products each of which is demanded as a final good and as an input in the production of other goods. For the sake of simplicity, it is supposed that intermediate goods and final goods are the same. In order to concretize assume that the typical product within these varieties has total sales of 10 units, but

---

<sup>9</sup> For details about the phase diagram analysis and further thoughts on labor pooling regarding discussions about labor market clearing conditions and monopsony power for firms, the reader may refer to Krugman (1991b, p. 41-48).

that of 4 are sold to manufacturers of other varieties and accordingly it requires 4 units of intermediate inputs which are drawn from the same industry producing other varieties in order to produce that 10 units. Further assume that there are two locations possible for production, East and West, and each own these locations also include half of the final demand, that is 3 units of each variety of product. So, given these conditions where would a firm choose to locate? The answer depends on the location choice of other firms. If all other firms are located in the West, then 7 (3 final plus 4 intermediate) of the 10 units of total demand for a particular product that the firm produces will come from the West. This will stimulate a firm to locate its production in West as well because all of the firm's supplies of intermediate goods will come from West and locating there will provide a firm transportation cost advantage. Thus, both forward and backward linkages will create an incentive to concentrate production.

Based on the Marshall's insight on input sharing, Venables (1996) presents a formal general equilibrium model where agglomeration is generated by interaction between the location decisions of vertically integrated firms in industries that are linked through input-output structure. Downstream industry forms the market for upstream industry. Upstream industry considering market access are then attracted to areas where there are many downstream firms, which is a demand linkage. Apart from this, there is also a cost linkage such that firms in the downstream industry will face lower costs if they locate where there are many upstream firms since they will be saving in transportation costs in intermediate goods. So, both cost and demand linkages together will act as centripetal forces for the agglomeration of activity. On the other hand, location of immobile factors of production and final consumer demand will act as centrifugal forces working against agglomeration. Characteristics of the industry, especially the strength of vertical linkages between industries and the cost of transportation between locations will determine the balance centripetal and centrifugal forces which will in turn determine the extent of agglomeration. As a result, unique or multiple equilibria may arise which comprises either dispersed production or the concentration of production at a single location<sup>10</sup>. It is important to highlight that linkages derive their effect from the interaction of trade cost with increasing returns to scale and imperfect competition.

---

<sup>10</sup> Krugman and Venables (1995) assume that the upstream and downstream industries are really the same to simplify the basic insight of input-output structure between firms. That means the same goods are consumed and used as inputs to production of other goods. In international economics framework they present a formal of industry concentration where the world is divided into two parts North and East and show that gradual process of expanding world trade as a result of falling transportation costs cause the world to divide into a high-wage, industrialized North

*Knowledge spillovers*: Third and most compelling Marshallian externality explaining agglomeration is *knowledge spillovers*. He asserts the benefits of knowledge spillovers as follows:

*“The mysteries of the trade become no mystery; but are as it were in the air... Good work is rightly appreciated, inventions and improvements in machinery, in processes and the general organization of the business have their merits promptly discussed: if one man starts a new idea, it is taken up by others and combined with suggestions of their own; and thus, it becomes the source of further new ideas”*(Marshall, 1890, p. 270)

Knowledge spillovers emanates from non-market interactions such as imitation, business interactions, face to face communication, inter-firm circulation of skilled labor without involving any monetary transaction. These type of interactions paves the way for transmission and exchange of knowledge, ideas, information, products and processes. Since the firm that creates the new knowledge cannot fully appropriate it, this knowledge spills over to other firms affecting their innovativeness positively. Also, it contributes to the stock of knowledge available for each firm in the industry. Knowledge that spills over is tacit by definition, it is uncodified and can only be acquired via social interactions, hence distance matters. As they are geographically bounded to regions in which the new knowledge is created, geographic proximity becomes essential and creates an incentive for firms to locate in these regions (Beaudry and Schiffauerova, 2009). Urban economics literature widely explores knowledge spillovers as a source of urban agglomerations<sup>11</sup> which is commonly known as *MAR (Marshall-Arrow-Romer) externalities* as later formalized by Glaeser, Kallal, Scheinkman, and Shleifer (1992).

At this point it would be useful to make a distinction between three types of externalities asserted by Marshall. First two types of externalities discussed above (labor pooling and input sharing) as a source of agglomeration are *pecuniary externalities* which refer to “the benefits of economic interactions which take place through usual market mechanisms via the mediation of prices” (Fujita and Thisse, 1996, p. 345). On the other hand, *technological externalities* arise through non-market interactions via processes affecting the utility

---

and a low-wage, primary-producing South. Later, as transportation costs continue falling South rises again at the expense of North

11 For a theoretical survey on the micro-foundations of urban agglomeration economies the reader may refer to Rosenthal and Strange (2004). Contrary to taxonomy made previously in Marshallian externalities, they distinguish theories by the mechanism driving them and identify three types of micro-foundations, based on sharing, matching, and learning mechanisms. First presenting a core urban model under each category, they discuss the literature in relation to those models.

function of individuals or production function of firms<sup>12</sup>. Generally, a wide range of theoretical models in urban economics are based on technological externalities in the form of knowledge spillovers, business communications, face-to-face communication, and other spatial externalities. Treating externalities arising from non-market interactions as external to the firm but internal to the industry allows these models to work under constant returns to scale and perfect competition, which is likely to explain why these models appeared long before the development of NEG (Fujita and Thisse, 2009).

However, new economic geographers, who perceive technological externalities as *knowledge spillovers* or *pure Marshallian externalities*, have been rather shy on this topic. Theoretical NEG models are solidly based on pecuniary externalities where forward and backward linkages (through input-output structure as in Krugman and Venables (1995) or between firms and workers/customers as in Krugman (1991a)) in conjunction with increasing returns and transportation costs are able to generate agglomeration endogenously without making further a priori assumptions about location of economic activity. Fujita and Thisse (2009) describe technological externalities as “black box” that hide the actual micro- interactions causing such externalities to arise. In Fujita and Krugman (2004, p. 160) Krugman notes that: “This is not because I do not agree with the potential importance of such agglomeration forces, but because I could not find any solid micro-model of knowledge spillovers or communications”. And they summarize the disadvantages of pure externality models as follows:

*“In particular, the sources of external economies are vague, at best. When normative or policy questions are addressed, we need to know more precisely the nature of external economies. Furthermore, since the underlying mechanisms of external economies are not clear, their spatial extent can be specified only exogenously in an ad hoc manner. Even when the spatial process of external economies is well-specified, the essential details regarding the information/knowledge externalities are often missing. For example, in communication externality models of urban morphology (Fujita and Thisse 2002, Chapter 6), although the communication process is well specified, it is not clear what information is exchanged and how it is utilised by firms. Furthermore, the nature of information/knowledge externalities is essentially dynamic, and hence their full-fledged treatment requires a dynamic framework” (Fujita and Krugman, 2004, p. 160).*

Now, the fundamental pillars of NEG and its remarks on the agglomeration phenomenon may be considered.

---

<sup>12</sup> The original discussion about the nature of externalities has been provided by Scitovsky (1954) where he distinguished externalities as *pecuniary* and *technological*.

### 3.3. Increasing Returns and Transportation Costs

As discussed in previous section agglomerations occur through both technological and pecuniary externalities. Even though Marshall has not provided the channels through which agglomeration arises, the urban economics literature put a special emphasis on external increasing returns as a requisite for agglomeration. However, on the one hand working within the framework of external scale economies enables one to deal with constant returns to scale and competitive markets, on the other hand it requires the location of economic activity to be specified exogenously since it cannot be derived from the model. The main line of NEG is “how to explain the formation of a large variety of economic agglomeration in geographical space” (Fujita and Krugman, 2004, p. 140). Geographic concentration of economic activities is the outcome of two opposing forces, *centripetal* forces that tend to pull economic activity together and the *centrifugal* forces that tend to push it apart. NEG demonstrates how the geographical structure of the economy is shaped by the tension between these forces by providing them micro founded explanations in a full-fledged general equilibrium setting.

*Centripetal* forces listed in the first column of Table 1 are in fact three Marshallian sources of external economies discussed in the previous section. A large local market creates both backward linkages (i.e., locations with better access to large markets are preferred for production subject to scale economies) and forward linkages (i.e., a large local market promotes the local production of intermediate goods by lowering the costs of downstream firms). A thick labor market, especially for specialized skills, allows firms to access workers easier and vice versa. And an industrial concentration may create pure external economies via knowledge spillovers. *Centrifugal* forces are listed on the second column. Immobile factors, which involve land, natural resources and, in an international context, workers, preclude concentration of production both from supply side (some production locates in where the workers are) and demand side (some production locates close to consumers due to dispersed markets). Land rents tend to increase due to the concentration of economic activity since demand for local land increases, and accordingly this creates a disincentive for further concentration. Also, concentration of production is likely to create pure external diseconomies such as congestion (Krugman, 1998).

*Table 1: Forces Affecting Geographical Concentration*

<b>Centripetal forces</b>	<b>Centrifugal forces</b>
Market-size effects (linkages)	Immobile factors
Thick labor markets	Land rents
Pure external economies	Pure external dis-economies

Source: Krugman (1998)

Without doubt, real world agglomeration phenomenon arises out of interactions between all these forces but NEG focuses on the first item of each column in Table 1 to conduct analytical work on economic geography. The choice of centripetal and centrifugal forces, namely linkages and immobile factors, definitely reflects concrete modelling concerns<sup>13</sup>. The modelling strategy of NEG allows for an “approach that concentrates on the role of market-size effects in generating linkages that foster geographical concentration, on one side, and the opposing force of immobile factors working against such concentration on the other” (Krugman, 1998, p. 9).

The seminal work of Krugman (1991a) introduces a framework that demonstrates the interactions among increasing returns at the firm level, transport costs and factor mobility give rise to spatial economic structure to emerge and change. The existence of increasing returns at the firm level is a crucial factor in explaining agglomeration which assures economy not to give way to so called ‘backyard capitalism’<sup>14</sup>. The indivisibilities existent in production motive firms to concentrate production in a small number of plants. It is more profitable for firms to produce on a large scale in a few places and trade its goods to dispersed consumers which allows them to avoid fixed costs that would arise in the case of dispersed production. So, increasing returns constitute the centripetal force for agglomeration. However, it is important to note that geographic extension of markets prevents production to concentrate only in a single place because transportation is costly. Hence, spatial dispersion of demand acts as a centrifugal force. Therefore, a trade-off arises between increasing returns and transportation costs for the firms to consider whether to concentrate production or not (Fujita and Thisse,

13 For an elaborative discussion on modelling strategy and principles of NEG the reader may refer to Krugman (1998, 1999).

14 The assumption of non-increasing returns has dramatic implications for economic geographers. Under this assumption, coupled with the uniform distribution of resources, the economy reduces into Robinson Crusoe economy where each individual produces for herself/himself which is called backyard capitalism. Without recognizing indivisibilities, each location operates as an autarky where goods are produced on a small scale sufficient to meet local demand. Trade possibly occurs between locations if the distribution of resources is not uniform (as in traditional trade theory). It is obvious that unequal distribution of resources is an insufficient explanation for understanding geographic concentration phenomenon (Fujita and Thisse, 1996).



1996). Furthermore, factor mobility will have a reinforcing effect on the concentration of production. To gain the basic insight about how agglomeration emerges out of the interaction among these factors, the *core-periphery* model of Krugman (1991a) will be mentioned in general terms<sup>15</sup>.

The basic framework of the model introduced by Krugman (1991a) can be described as follows. There are two regions, two sectors (agriculture and manufacturing) and two types of labor (farmers and workers). The manufacturing sector produces a continuum of horizontally differentiated products where each firm produces a different variety of product under increasing returns to scale using workers as the only input<sup>16</sup>. On the other side, agricultural sector produces a homogenous product under constant returns with farmers used as the only input for production. Workers are freely mobile between two regions while farmers are immobile and equally distributed between two regions. Finally, the agricultural good is traded costless between two regions whereas the inter-regional trade of manufacturing goods involves a positive transport cost in the form of *iceberg*<sup>17</sup>(Fujita and Krugman, 2004).

In this model, centrifugal forces are created by immobility of farmers as they consume both goods and firms may choose to locate closer to them to meet the demand for manufactured goods. Centripetal forces are more complex and involves a circular causation as shown in Figure 1. First, if a large number of firms are located in region 1, a greater number of varieties are produced. Workers (who are also consumers) will have a better access to a greater number of varieties compared to workers in region 2. In addition to this love of variety, there is also price index effect at work. The equilibrium price index of manufactured goods faced by consumers will be lower in region 1 because firms do not undertake price discrimination between regions.

---

<sup>15</sup> For a formal presentation of the model the reader may refer to the original paper.

<sup>16</sup> This feature derives due to employing monopolistic competition model introduced by Dixit and Stiglitz (1977) which assumes a continuum of goods that allows the modeler to “respect the integer nature of many location decisions - no fractional plants allowed - yet analyse their models in terms of the behaviour of continuous variables such as the share of manufacturing in a particular region” (Krugman, 1999, p. 146).

<sup>17</sup> *Iceberg* transport costs are first introduced by Samuelson (1954) which asserts that “a fraction of any good shipped simply ‘melts away’ in transit, so that transport costs are in effect incurred in the good shipped”(Krugman, 1999, p. 146). Modelling transportation costs this way allows one to avoid modelling transportation sector as a separate one in a general equilibrium framework.



Figure 1: Circular Causation Created by Centripetal Forces

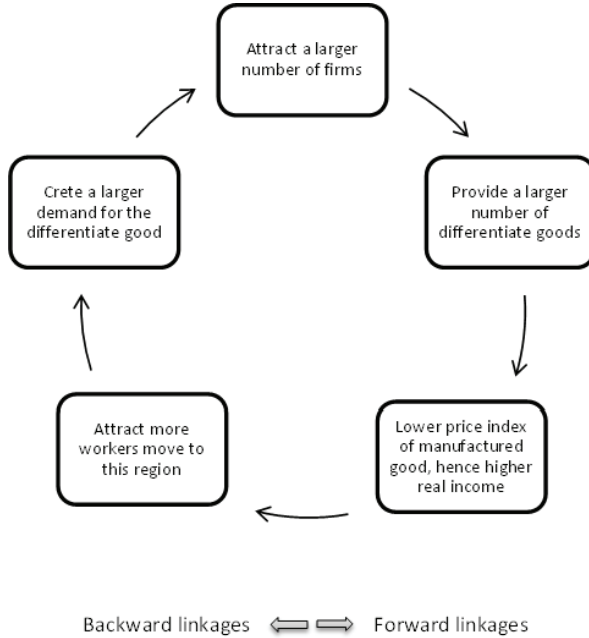

Source: Author's illustration based on Krugman (1991a)

Thus, lower price index will generate a real income effect for workers in region 1 which will induce more workers to migrate there from region 2. An increase in the number of workers in region 1, who are also consumers, triggers the concentration process as follows. The resulting increase in the number of workers (consumers) creates a larger demand for manufactured goods in region 1 which lead more firms to locate there via home market effect. Because of scale economies there is an incentive to concentrate production of each variety in only one region and because of transportation costs it is more profitable to produce in the region offering a larger market and ship to the other. This implies the production and availability of even more varieties of differentiated product in region 1, where the cycle starts again. Briefly, a circular causation for agglomeration of firms and workers is generated through *forward linkages* (workers' motive to be close to the producers of consumer goods) and *backward linkages* (producers' motive to concentrate where the market is larger) (Fujita and Thisse (1996), Fujita and Krugman (2004)).

Krugman (1991a) shows that, if forward and backward linkages are strong enough to surpass centrifugal forces generated by immobile farmers, the economy will end up with *core-periphery* pattern in which all manufacturing is concentrated in only one region. The emergence

of *core-periphery* pattern is more likely (i) when transportation costs for manufacturing is low enough, (ii) when varieties of products are sufficiently differentiated and (iii) when the share of manufacturing sector in the economy is large enough. Agglomeration may or not occur due to the parameter values of the model. However, a small change in critical parameters may move the economy from one in which two regions are symmetric to the one in which initial advantages cumulate and transform one region into an industrial core and the other into de-industrialized periphery. That means the dynamics of the model are subject to *catastrophic bifurcations* which refers to points at which their qualitative character suddenly changes (Fujita and Krugman, 2004).

#### 4. Concluding remarks

Originating from the early discussions of von Thünen, localization of economic activity has attracted attention from many scholars related to different disciplines. 1950's witnessed the rise of regional science which is followed by urban economics in 1960's. However, it had to await for almost thirty years for location to be considered as an important integral part of economics. With the rise of new economic geography in early 1990's, the attention of scientists has shifted on the role of space and geography in understanding the distribution of economic activity.

Without doubt, an extensive review of the locational analysis within the vast body of theoretical literature has been beyond the scope of this study and is the interest of another research per se. Instead, this study presented a brief overview of the locational analysis enlightening the path to the emergence of new economic geography. It is clearly seen that NEG models have opened up a new way of theorizing agglomeration phenomenon. Based on the same modelling architecture and modelling tricks, this framework also contributed to the development of regional models, urban system models and international models (discussed in detail in Fujita, Krugman, and Venables (2001)) in which agglomeration emerges without making a priori assumptions in a general equilibrium setting. This new field have been respected by other disciplines such as urban economics and regional science despite employing different approaches and the search for a unifying mechanism between NEG and these disciplines began<sup>18</sup>. Yet, it is still open to developments and experiencing advances progressively.

---

18 Behrens and Thisse (2007) show that concepts and tools developed in NEG may be used to revisit several problems in regional economics.

## BIBLIOGRAPHY

- Balassa, B. (1966). Tariff reductions and trade in manufacturers among the industrial countries, *The American Economic Review*, 56(3), 466–473.
- Beaudry, C., & Schiffauerova, A. (2009). Who's right, Marshall or Jacobs? The localization versus urbanization debate. *Research Policy*, 38(2), 318–337.
- Behrens, K., & Thisse, J. F. (2007). Regional economics: A new economic geography perspective," *Regional Science and Urban Economics*, 37(4), 457–465.
- Chamberlin, E. (1933). *The Theory of Monopolistic Competition*. Cambridge, MA: Harvard University Press.
- Christaller, W. (1933). *Central Places in Southern Germany*. London, Prentice Hall.
- Committee, Nobel Prize. (2008). Paul Krugman: Trade and Geography - Economies of Scale, Differentiated Products and Transport Costs. Nobel Prize in Economics documents 2008-2, Nobel Prize Committee.
- Dixit, A. K., & Stiglitz, J. E. (1977). Monopolistic competition and optimum product diversity. *The American Economic Review*, 67(3), 297–308.
- Ellison, G., & Glaeser, E. (1999). The geographic concentration of industry: Does natural advantage explain agglomeration? *American Economic Review*, 89(2), 311–316.
- Ellison, G., & Glaeser, E. L. (1997). Geographic Concentration in U.S. Manufacturing Industries: A Dartboard Approach. *Journal of Political Economy*, 105(5), 889–927.
- Fujita, M. (2010). The evolution of spatial economics: from Thünen to the New Economic Geography. *Japanese Economic Review*, 61(1), 1–32.
- Fujita, M., & Krugman, P. (2004). The New Economic Geography: Past, present and the future. *Papers in Regional Science*, 83(1), 139–164.
- Fujita, M., P. R. Krugman, & Venables, A. (2001). *The Spatial Economy: Cities, Regions and International Trade*. MIT press.
- Fujita, M., & Thisse, J. F. (1996). Economics of agglomeration. *Journal of the Japanese and International Economies*, 10(4), 339–378.
- Fujita, M., & Thisse, J. F. (2002). *Economics of agglomeration: Cities, industrial location, and regional growth*. Cambridge: Cambridge University Press.
- Fujita, M., & Thisse, J. F. (2009). New Economic Geography: An appraisal on the occasion of Paul Krugman's 2008 Nobel Prize in Economic Sciences. *Regional Science and Urban Economics*, 39(2), 109–119.

- Glaeser, E. L., Kallal, H. D., Scheinkman, J. A. & Shleifer, A. (1992). Growth in Cities. *Journal of Political Economy*, 100(6), 1126–52.
- Hoover, E. M. (1937). Spatial price discrimination. *The Review of Economic Studies*, 4(3), 182–191.
- Hoover, E. M. (1936). The Measurement of Industrial Localization. *The Review of Economics and Statistics*, 18(4), pp. 162–171.
- Hotelling, H. (1929). Stability in competition. *Economic Journal*, 39, 41–57.
- Isard, W. (1949). The general theory of location and space-economy. *The Quarterly Journal of Economics*, 63, 476–506.
- Kaldor, N. (1935). Market imperfection and excess capacity. *Economica*, 2(5), 33–50.
- Karlsson, C. (2008). Chapter 1: Introduction. In C. Karlsson (Ed.) *Handbook of Research on Cluster Theory*, Vol. 1 (pp. 1–19). Edward Elgar Publishing.
- Kim, S. (1999). Regions, resources, and economic geography: Sources of US regional comparative advantage, 1880–1987. *Regional Science and Urban Economics*, 29(1), 1–32.
- Koopmans, T. C., & Beckmann, M. (1957). Assignment problems and the location of economic activities. *Econometrica*, 25(1), 53–76.
- Krugman, P. (1979). Increasing returns, monopolistic competition, and international trade. *Journal of International Economics*, 9(4), 469–479.
- Krugman, P. (1980). Scale economies, product differentiation, and the pattern of trade. *The American Economic Review*, 70(5), 950–959.
- Krugman, P. (1981). Intra-industry specialization and the gains from trade. *The Journal of Political Economy*, 89(5), 959–973.
- Krugman, P. (1991a). Increasing returns and economic geography. *The Journal of Political Economy*, 99(3), 483–499.
- Krugman, P. (1991b). *Geography and Trade*. MIT press.
- Krugman, P. (1993). First nature, second nature, and metropolitan location. *Journal of Regional Science*, 33(2), 129–144.
- Krugman, P. (1998). What's new about the New Economic Geography? *Oxford Review of Economic Policy*, 14(2), 7–17.
- Krugman, P. (1999). The role of geography in development. *International Regional Science Review*, 22(2), 142–161.
- Krugman, P. (2009). The increasing returns revolution in trade and geography. *The American Economic Review*, 99(3), 561–571.
- Krugman, P., & Venables, A. J. (1995). Globalization and the Inequality of Nations. *The Quarterly Journal of Economics*, 110(4), 857–880.

- Launhardt, W. (1885). *Mathematische Begründung der Volkswirtschaftslehre*. Leipzig: B.G. Teubner. Translated from German by B.G. Teubner (1993) *Mathematical Principles of Economics*, Aldershot: Edward Elgar.
- Lösch, A. (1940). *The Economics of Location*. English translation by William H. Woglom, New Haven, Yale University Press, 1954.
- Marshall, A. (1890). *Principles of Economics*. Macmillan London, 8th edition published in 1920.
- Ohlin, B. (1933). *Interregional and International Trade*. Cambridge, MA: Harvard University Press.
- Ottaviano, G., & Thisse, J. F. (2004). Agglomeration and economic geography. *Handbook of Regional and Urban Economics*, 4, 2563–2608.
- Palander, T. (1935). *Beiträge Zur Standortstheorie*. Uppsala: Almqvist & Wiksells Boktryckeri AB.
- Robinson, J. (1933). *Economics of Imperfect Competition*. London: Macmillan.
- Romer, P. M. (1986). Increasing returns and long-run growth. *The Journal of Political Economy*, 94(5), 1002–1037.
- Romer, P. M. (1987). Growth based on increasing returns due to specialization. *The American Economic Review*, 77(2), 56–62.
- Romer, P. M. (1990). Are Nonconvexities Important for Understanding Growth? *American Economic Review*, 80(2), 97–103.
- Rosenthal, S., & Strange, W. (2004). Evidence on the nature and sources of agglomeration economies. In V. J. Henderson & J. F. Thisse (Eds.), *Handbook of Regional and Urban Economics*, Vol. 4 (pp. 2119–2171). Amsterdam, North-Holland: Elsevier.
- Samuelson, P. A. (1954). The transfer problem and transport costs, II: Analysis of effects of trade impediments. *The Economic Journal*, 64, 264–289.
- Samuelson, P. A. (1983). Thünen at Two Hundred. *Journal of Economic Literature*, 21, 1468–1488.
- Scitovsky, T. (1954). Two Concepts of External Economies. *Journal of Political Economy*, 62(2), 143–151.
- Starrett, D. (1978). Market allocations of location choice in a model with free mobility. *Journal of Economic Theory*, 17(1), 21–37.
- Venables, A. J. (1996). Equilibrium Locations of Vertically Linked Industries. *International Economic Review*, 37(2), 341–359.
- von Thünen, J. (1826). *Der Isolierte Staat in Beziehung auf Landschaft und Nationalökonomie*. English Translation by C.M. Warterberg, von Thünen's Isolated State, Oxford: Pergamon Press, 1912, Hamburg.
- Weber, A. (1909). *Theory of the Location of Industries*. Chicago: The University of Chicago Press, 1929. Translation by C. J. Friedrich.



“

## Chapter 12

### **CUSTOMER RELATIONSHIP MANAGEMENT’S IMPACT ON CUSTOMER SATISFACTION AND PERFORMANCE OF SALES PROFESSIONALS**

*Enis PEKER<sup>1</sup>*

*Yalçın KIRDAR<sup>2</sup>*

”

---

1 Dr., Schneider Electric - Secure Power Business Unit, Kadıkoy/Istanbul, Orcid Id: 0000-0001-7275-992X, E-mail: pekerenis@yahoo.com

2 Prof. Dr., Istinye University Vice Dean Faculty of Communication - Head of Public Relations and Advertising Department, Orcid Id: 0000-0002-1417-244X, E-mail: yalcin.kirdar@istinye.edu.tr

Peker, E. & Kırdar, Y. (2021). *Customer Relationship Management's Impact On Customer Satisfaction And Sales Professionals' Sales Performance: Turkey's Top 500 Companies*. (Doctorate Thesis). Department of Public Relations and Publicity, Public Relations and Publicity Programme, Maltepe University Graduate School. Istanbul

## 1. Introduction

We are in the 21st century which includes threats, challenges and as well as opportunities. The exponentially increasing speed of technological developments, constantly changing needs and trends of customers are also changing the way of businesses interaction of companies with their customers.

Companies are trying to gain competitive advantage by using marketing and sales organizations together. Especially, while customer-oriented approaches support CRM initiatives, an integrated CRM will support the strengthening of customer relations, increase of customer satisfaction and loyalty and sales performance positively.

Many companies have perceived CRM that accompanied by numerous uncoordinated initiatives as a technological solution for problems in individual areas. However, CRM should be considered as a strategy when a company decides to implement it due to its humanitarian, technological and process-related effects (Mendoza et al., 2007, p. 913). CRM is evolving today as it should be seen as a strategy for maintaining a long-term relationship with customers.

A CRM business strategy includes the internet with the marketing, sales, operations, customer services, human resources, R&D, finance, and information technology departments to achieve the company's purpose and maximize the profitability of customer interactions (Chen and Popovich, 2003, p. 673).

After Corona Virus Disease-2019/Covid-19 (Coronavirus) first appeared in Wuhan, China towards the end of 2019, its effects began to be felt clearly all over the world. If the Coronavirus crisis is not managed properly in business-to-business (B2B) and business-to-consumer (B2C) sectors, it can have serious negative consequences. In this crisis, companies can typically face significant losses in their sales performance, existing customers and customer satisfaction, interruptions in operations and accordingly bankruptcy.

## 2. Problem

In today's world where the changing dynamism of business life and the competition brought by globalization is felt more and more each day, it has become very important to develop and maintain long-term relationships with customers.

Thanks to the rapidly advancing technology in the recent past and today, production techniques are developed, products and services are



easily imitated, becoming abundant and competition is much more effective. In this sense, one of the most important factors affecting companies that dominate business life and use the latest technologies is competition. According to Demir and Kırdar (2013), competition has never tired the manufacturers, marketing, and sales teams this much in any previous period. For companies that have to sell more every day and compete fiercely, it is a serious necessity to gain customers and not lose what they have gained (Kırdar and Demir, 2013, p.294). For companies that providing the best customer satisfaction, as well as managing the sales team effectively and in line with the targeted results, is increasingly important for middle and senior management.

Today, companies should be able to collect, evaluate and use customer information in the best way in order to increase and keep their market shares, profitability, customer satisfaction high, and to keep their customers in the long-term. It is great importance where and how the data collected from customers will be used in the most accurate way (Demirbağ, 2004, p.7).

Considering the evolving and changing customer expectations, competition, and market structures, it can be said that traditional sales organizations and processes are and will be under pressure (Piercy, 2010, p.349). In this sense, CRM is directly related to customer satisfaction, marketing and sales goals and concerns (Demirbağ, 2004, p.35).

### **3. Goal**

It is to investigate and evaluate the impact of CRM on the customer satisfaction and as well as the sales performance of sales professionals of companies in the B2B and B2C business areas in Turkey's largest 500 companies (Fortune 500).

#### **Hypothesis**

- **H1:** The usage of CRM provides increased performance with customers.
- **H2:** The usage of CRM provides increased of sales process effectiveness.
- **H3:** The usage of CRM positively affects customer satisfaction.
- **H4:** Customer satisfaction positively affects the increase in performance with customers.
- **H5:** Customer satisfaction positively affects the increase of sales process effectiveness.

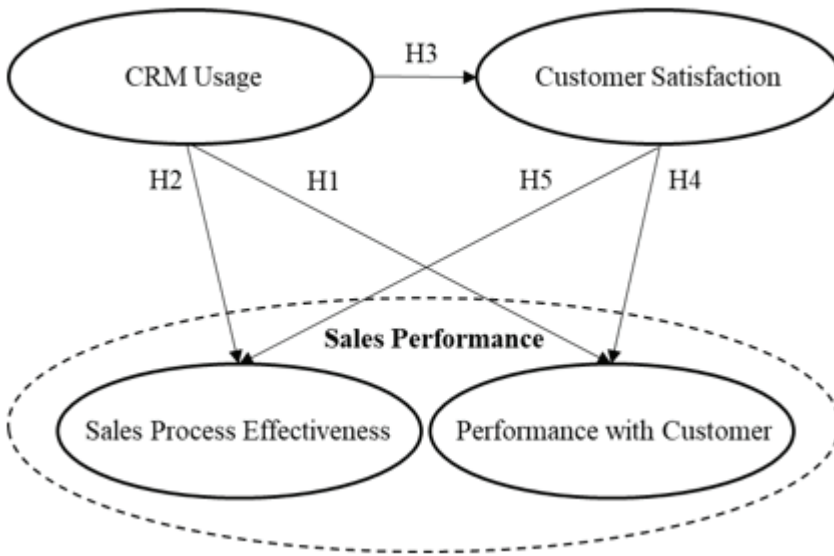

#### 4. Importance

CRM in Turkey is still an established and developing concept, and it is seen that the rate of usage and success is low, especially compared to CRM applications in the USA where is the place of origin. Large companies in Turkey are convinced of CRM, but for small and medium-sized enterprises (SMEs), CRM is seen as a costly system which large companies can use (Demirbağ, 2004, p.47,48).

In this study, as companies in the B2B and B2C business areas within the scope of Turkey's 500 largest companies determined according to company turnover in 2019, the effect of CRM on customer satisfaction and the performance of sales professionals will be discussed, and also the CRM information about the level of application of the concept in companies in Turkey today will also be obtained.

When the studies in the field are examined, it is stated that CRM is not only technological infrastructure and software platform, but also a customer-oriented business, competition, and management strategy. Although CRM emerges from a technology-centered idea, the main issue that needs to be emphasized is the fact that customer relations arise from a human-centered and human relations-intensive understanding. Therefore, while evaluating the subject, technology should be evaluated as integrated with human (Özdağoğlu, Özdağoğlu and Öz, 2008, p.368).

CRM has the purpose of acquiring and maintaining loyal customers, as well as managing long-term profitable relationships with customers.

Strong customer relationships are associated with behavioral outcomes such as customers recommending others about the business and its products, customer retention, share of wallet, cross selling. This situation can also reduce the costs of the business to find new customers (Gültekin and Kement, 2018, p.42).

The strategic use of CRM helps reduce the resources, effort, and time wasted in sales professionals' interactions with B2B buyers, because B2C purchases are less complex and relationship-based than B2B. (Saini et al., 2010, p.368).

The use of CRM helps to go deeper into pre-sales and post-sales support based on a historical analysis of the buyer's needs. It is easier to cross-sell or incrementally up-sell in B2B purchases, because CRM realizes relational state dependency in B2B purchases and makes it more useful than B2C purchases.

## **5. Definitions**

### **5.1 Customer Relationship Management - CRM**

The effect of globalization, technological developments, the decreasing in demands in today's markets, the increasing demands and needs of customers with the emerging intense competition have brought CRM to an important and critical position.

On the other hand, the understanding of marketing has become obligatory from the product to the customer-centered approach, and according to this approach, the power is no longer with the producer, but with the customer.

Research by Mishra (2009) has shown that more and more companies are realizing the importance of being customer-centric in today's competitive era, adopting CRM as a core business strategy, concluded that CRM can help companies manage their interactions with customers more effectively to remain competitive (Mishra and Mishra, 2009, p.83).

It is much more important than past for companies to be closer to customers, manage relationships and understand them in order to achieve their goals. In this sense, CRM is successful and effective in managing such an important change.

CRM has also increased the opportunity for companies to understand what their customers have done in the past, their current needs and

their plans to reach their future goals. On the other hand, in addition to increasing customer loyalty, it also improves the communication between the company and its customers (Xu, Yen, Lin and Chou, 2002, p.445).

While CRM is generally designed to help companies to organize their sales activities, but not all CRM systems are suitable for companies. In this sense, CRM differs in terms of features and use cases for B2B and B2C sectors.

CRM is a long-term investment and company management should know that this investment is long-term and the economic return will be also long-term (Xu et al., 2002, p.446, 448). For this reason, CRM should be seen as a management strategy of the company, planned, and implemented with very detailed and supported by employees at all levels within the company. Because, one of the most important problems in CRM applications is the resistance of company employees. (Xu et al., 2002, p.447).

If we look at the definitions of CRM made within the scope of studies;

- CRM is not only an information technology, but also a comprehensive business strategy (Crosby, 2002, p.271).

- CRM is all the tools, techniques and methods that enable the company to manage and improve its relations with existing and prospective customers and business partners, sales, and support units (Zeng et al., 2003, p.39).

- CRM is a concept that aims to establish a strategy and long-term customer relations, which places the concept of customer throughout the business, adopting the culture of being customer-oriented, and accordingly profitability (Ersoy, 2002, p.5).

- CRM is an integrated information system used to plan, implement, and control an organization's pre-sales and after-sales activities. This communication strategy, which is based on understanding the individual needs of customers and establishing a deeper and long-term relationship with them, is not a technology (Drummond, 2001, p.16).

- As a holistic approach, CRM best integrates sales, marketing, customer service, field support and other units that are in relationship with customers. It is also a concept that provides how companies can retain their valuable customers, maintain long-term relationships with them and at the same time reduce costs. Because, technological developments and other applications can be imitated in a very short time and this situation can not maintain its competitive advantage in the long-term. The "customer relations" created by the company as a result of long and laborious efforts can be difficult and costly to imitate (Odabaşı, 2015, p.1).

The purposes of CRM;

- Adapting the strategies of the customers and the processes of the company in order to create customer loyalty and long-term profitability (Rigby, Reichheld and Scheffer, 2002, p.103).

- To improve customer relations by producing products and services in line with customer needs in sales, marketing, and customer services with the integration of all channels with which the customer is contacted (Demirbağ, 2004, p.6).

- Making customer relations profitable, providing differentiation, minimizing costs, increasing the efficiency of the business, providing harmonious activities and meeting customer demands (Kırım, 2001, p.104).

CRM database can have huge potential data, details of previous purchases, contact details, hobbies and details of supports requested in the past, etc. However, using CRM programs as expected can be complicated and difficult. For this reason, it is important that the employees who will use the CRM program have received the necessary training and that their training is maintained according to current information. This approach is necessary and important especially for sales professionals, because a sales professional is in contact with customers after the first sale. If the information obtained from customers is not correct and up-to-date, clues to understanding customers' needs and demands may be missed.

## **5.2 Business-to-Business – B2B**

B2B sales, in short, is commercial transactions between companies.

It is possible to talk about two types of sales in B2B sales. First, selling products such as office supplies, consumables, and computer equipment that meet the needs of a business. This sales approach is similar to the B2C process, but includes extra steps such as getting approval from a department or purchasing manager. In general, for expensive or complex products and solutions, the sales cycle on the buying side is longer and more people are involved. Second, it is the sale of components to companies that they will use to manufacture their own products. For example, when a tire manufacturer sells tires to a car manufacturer.

B2B transactions are more applicable to manufacturing firms. Wholesalers sell their products to retailers, who in turn sell these products to end-consumers. Supermarkets are a great example of this, another example being that Samsung is one of the largest suppliers of Apple display products for iPhone manufacturing. Apple also maintains B2B relationships with companies such as Intel, Panasonic, and semiconductor manufacturer Micron Technology.

The Coronavirus crisis is affecting B2B companies, particularly marketing and sales operations.

In this sense, it appears to have heavy implications for most B2B firms in the world. The decrease in sales triggers intra-organizational and inter-organizational tension, revealing the necessity of new approaches to manage the business operations of companies.

The Coronavirus crisis has shown that most B2B companies and societies in general are unprepared to deal with a crisis of such magnitude and nature.

According to Cortez and Johnston (2020), lock-down in the context of implementation decisions taken during the Coronavirus crisis has proven its weakness regarding the digital transformation of B2B companies (Cortez and Johnston, 2020, p.126).

### **5.3 Business-to-Consumer – B2C**

B2C sales, in short, is business transactions between companies and consumers, that is end-users.

For many years, as a result of the efforts of individuals, consumer movements, lawmakers, and the media, but with the help of today's technologies, more development of the role of the customer has been achieved from one-way approach such as CRM to two-way interaction (Gummesson and Polese, 2009, p.343). B2C CRM has been developed specifically to meet the business needs of customer-facing companies. Sales cycles are often shorter and customer potential is high. The CRM must be dynamic enough to identify where sales are and which source generates the highest revenue, in addition the internal search engine must be very efficient and the segmentation of data well-structured as B2C CRMs need to handle large volumes of data.

The adoption of electronic commerce (e-commerce) by customers in B2C is attractive due to the distinguishing features of e-commerce such as speed, time, location, cost and availability of alternatives (Shareef et al., 2008, p.166,168). With e-commerce from B2C, a new structure has emerged with direct sales by companies to individuals. This type of trade between businesses and consumers can be defined as the sale of products and services to the consumer via the internet in a way that can not be resold or exchanged, for example; Amazon, Hepsiburada and Trendyol, etc. as the rate of internet usage increases, B2C e-commerce, which is expected to grow rapidly, creates new opportunities for SMEs are seen as backbone of the economy (Şahbaz, Sökmen & Aytaç, 2014, p.2).

## 5.4 Customer Satisfaction

Today's modern, visionary, and customer-oriented companies try to be customer-oriented in all their activities and are aware that they can only have an advantage over their competitors in a competitive environment to the extent that they achieve high customer satisfaction.

Customer satisfaction is an important value for companies that strive to survive in the dynamic conditions of increasingly competitive and changing business life, so companies that aim for absolute customer satisfaction by understanding the current and future expectations and needs of the customer can survive. Because satisfied customers gain new customers with their positive speeches, but otherwise, dissatisfied customers cause loss of customers with their negative speeches. Naturally, different customers may have different expectations, and customer satisfaction also depends on expectations, so the fact that a product or service meets different demands and expectations of customers has a significant impact on customer satisfaction.

The most important condition for maintaining a continuous advantage in the competition is to ensure customer satisfaction. All initiatives and results, such as improving operational processes of companies, reducing costs, increasing profitability, improving existing investments or making new investments, depend on customers and their satisfaction. According to Fornell (1992), customer satisfaction can also reduce costs related to warranty services, complaints, defective products, and field service (Fornell, 1992, p.6,21).

According to Oliver (1997), satisfaction is the response to the fulfillment of the consumer's demands. It is a judgment that a product/service feature, or the product or service itself, is (or is not) provided at a happy level of satisfaction with consumption, including levels of under- or over-fulfillment (Oliver, 1997, p.8). Studies indicate that repeat purchases are high when products or services exceed customer expectations. Customers who trust a company will continue to buy products or services that satisfy them (Verma and Chaudhuri, 2009, p.57). According to Kotler (1997), customer satisfaction expresses product performance as meeting expectations, and dissatisfaction as falling behind expectations (Kotler, 1997, p.187).

Although there are some differences in the definition of satisfaction in the literature, all definitions share some common elements. When viewed as a whole, three general components can be identified: 1) Consumer satisfaction is a response (emotional or cognitive), 2) Response relates to a particular focus (expectations, product, consumption experience, etc.), and 3) The reaction occurs at a certain time (after choice and after consumption

based on accumulated experience etc.) (Giese and Cote, 2002, p.4).

Anderson et al. (1994) investigated the effects of customer satisfaction on the economic benefit and return of companies' sales, and the findings in the study showed that high customer satisfaction quality has a positive effect on the sales and profitability of the company (Anderson, Fornell and Lehmann, 1994, p.53).

In some cases, rewards are psychological management belief that if employees know that customers are satisfied, then employees will be more satisfied and work more effectively. In some cases, the rewards are hidden. Management believes that in the long-term, a satisfied customer is an asset of the firm, and this asset makes the firm more profitable. The measures of the customer satisfaction are indicator of future profit potential, because more satisfied customers will buy more, buy more often, buy at a higher price, and share their satisfaction with others (Hauser, Duncan and Simester, 1994, p.328,330).

Customer satisfaction to be obtained as a result of creating value for the customer can bring the following benefits to companies; 1-) Increase in repeated purchases at a higher rate, 2-) Increase in profit margins as a result of more conscious management of costs and expenses, 3-) Increase in motivation of employees and decrease in leaving the company, as creativity will be supported (Odabaşı, 2015, p.57).

The study by Hassan et al. (2014) showed that CRM has a significant effect on customer satisfaction. This research concluded that CRM plays an important role in increasing market share, increases productivity, raises employee morale, as well as increases in-depth customer knowledge and customer satisfaction (Hassan et al., 2014, p.563).

### **5.5 Sales and Sales Performance**

Marketing covers all stages as designing a product, producing it, delivering it to the end- consumer, and subsequent consumer support. Sales is the target stage that gives meaning to marketing activities.

According to the American Marketing Association (AMA), sales; “the function of helping and persuading a potential customer, either personally or impersonally, to buy a product/service or to welcome an idea that has commercial significance for its sale.” (Önce, 2015, p.31).

If we consider the design, production, advertisement, pricing, marketization, and presentation of a product to the consumer as marketing, we can call it a sale after this stage is presented to the consumer and bartered for an acceptable price. Marketing is a process and selling is a part of this process and therefore marketing cover selling.



When we evaluate it in terms of the past, we can see that sales and salespeople have different approaches in their sales activities and customer perspectives today. Önce (2015) compares traditional and modern ways of approaching sales and customers in Table 2 (data is not provided) below.

Today, markets are extremely competitive, and at the same time, the squeeze between revenue and profit targets and the cost of serving customers puts great pressure on salespeople to be productive in an intensely competitive environment. This brought a new responsibility to the sales personnel, helping to establish customer relations and increasing the cooperation between customers and companies (Hunter and Perreault, 2007, p.16).

The world of sales and sales management has changed dramatically in recent years. Sales organizations are also faced with increasing customer expectations, frequent and significant changes, increasingly complex purchasing situations, greater diversity on the customer side, and complex work environments. Due to these changes, sales managers and sales personnel are responsible for performance results more than ever before.

In addition, sales personnel are responsible for advising the customer and strengthening the buyer-seller relationship by helping to improve the customer's business and ensure customer satisfaction (Liu and Leach, 2001, p.147,149). It also plays a critical role in developing and maintaining customer relations and ensuring customer satisfaction (Cannon and Perreault, 1999, p.439).

No matter how well-organized and honest the company is, the person representing the company to the customer is always the salesperson, and for this reason, the customer's opinions, attitudes, and thoughts about the company change according to the impression left by the salesman. Otherwise, it is inevitable to fail in the end (Önce, 2015, p.29).

The highest performance in sales can be achieved, if companies have dynamic management systems to support their sales force (Ingram, 2004, p.18).

On the other hand, it can be difficult to control the activities and performance of sales personnel, because sales personnel often spend most of their time outside the company in the field. In particular, managers spend a significant amount of time collaborating with sales personnel in the field and observing the performance of sales personnel.

One of the most important issues in personal selling and sales management is the measurement of sales performance, in this sense, the most obvious measurement is the resulting sales amount. However, with the increasing importance of the role of customer satisfaction, customer

loyalty, long-term relationship management and customer information management in an organization's strategic success, companies look beyond unit sales transaction-based concepts and measured immediate revenue when evaluating and measuring sales performance (Zallocco et al., 2009, p.598).

According to Türker (1998), performance, in general terms, is a concept that determines the point reached in line with the plans made for a certain purpose. In other words, performance is the quantitative and qualitative definition of what an individual, group or enterprise can achieve and achieve in line with the goals aimed at that job (Akalin, 2005, p.2). Johnston and Marshall (2006) define sales performance as the behavior evaluated in terms of its contribution to the company's goals (Johnston and Marshall, 2006, p. 412).

Sales performance is an integrative component of a company's strategy. Sales performance measures should be consistent with organizational tasks and goals that support desired results and encourage salesperson behavior (Zallocco et al., 2009, p.604).

Hunter and Perreault (2006) investigated two important aspects of sales performance, performance with customers and internal role performance. Accordingly, performance with customers is the extent to which the salesperson establishes and develops relationships with the customer organization. They define performance with customers as understanding and developing a customer's unique problems and concerns (marketing, technology, operations) or otherwise proposing solutions to address those concerns. Internal performance, on the other hand, refers to the salesperson's contributions predominantly to the company's internal problems. This includes things like suggesting improvements in company operations and procedures, working as a dedicated resource in the cross-functional organization, getting to know the company's products, and keeping a close eye on the company's production schedules and technological developments (Hunter and Perreault, 2006, p.99).

According to Önce (2015), the specific reasons for evaluating sales force performance are as follows;

- To determine how and in which areas each sales personnel needs improvement and thus to allow individual development.
- Checking and evaluating sales force performance standards, poor performance can be indicative of inappropriate standards.
- Recognizing personnel deserving of a pay increase or reassignment to new districts or assignments.

- To maintain sales job descriptions according to changing market conditions.
- Cross-checking sales plans, training, supervision, assignment, regional assignments, and transaction processes (Önce, 2015, p.213).

As a precautionary measure during the Coronavirus pandemic period, many companies have turned to working either completely in the virtual environment or hybrid, that is, part-time office and homework, depending on the organizational structure and operational requirements. Accordingly, in order to remain competitive and achieve the desired levels in sales performance, it has become necessary to equip sales professionals with tools that enable them to access customer information and be more productive in today's virtual sales environment.

The study results of Avlonitis and Panagopoulos (2005) also show that a salesperson's beliefs about ease of use and use of CRM have a catalytic effect on sales performance. In addition, a CRM system that is perceived as a performance enhancer and has more functional capabilities can help sales personnel improve their work results (Avlonitis and Panagopoulos, 2005, p.364).

It is not only the result, but also the sales process has become visible to the management by CRM.

The processes incorporated into CRM provided a more structured approach to selling by guiding and making the work of sales staff more effective. In CRM effective control, the performance of sales personnel is not only measured by signed contracts, but also divided into intermediate results at each stage throughout the sales process, such as the number of sales generated and sales opportunities. The results have been adopted as criteria to evaluate the performance of employees, so the use of CRM has significantly strengthened performance management by improving the quality and level of detail of performance data (Li and Mao, 2012, p.269-273).

Technology will not replace a salesperson when products become more complex, relationships become more valuable, or the art of persuasion is required. Both can work independently of each other, but the greatest gains will be achieved through cooperation (Ahearne and Rapp, 2010, p.119).

## **6. Method**

### **6.1 Research Model**

In the scientific research, 5-point Likert question type approach was used by making phone interviews with the survey method, which is one

of the data collection techniques. In order to test the defined hypotheses, companies in the B2B and B2C business areas in Turkey's Fortune 500 which is determined as the 500 largest companies according to 2019 turnovers.

Companies in Fortune 500 were added to the framework system, and random sampling was searched randomly. Within the scope of the survey study, the interviews with the companies which do not use the CRM system were terminated. In addition, in the companies which using CRM, the employee contacted to the survey was first asked whether he/she used CRM or not, and those who answered "no" were excluded from the survey.

## 6.2 Population and Sample

The research population is the companies using CRM in the B2B and B2C business areas in Turkey, the sample in Turkey's largest 500 companies that officially declared their turnover for 2019 and determined as Fortune 500 who works in sales, marketing and related fields using CRM.

Of the Fortune 500 companies called by phone, 120 (24%) declared that they did not use CRM.

Accordingly, these 120 companies were excluded from the study.

Of the Fortune 500 companies called by phone, 380 (76%) declared that they used CRM. 103 people from those 380 companies that declared to use CRM agreed to be interviewed and 55 people refused. The majority of the people who did not want to be interviewed by refusing the interview, because they did not have time or did not use CRM effectively.

Due to Covid-19 pandemic conditions affecting business life, a list of 500 companies was called 1874 times in order to reach the number of 103 surveys answered.

Table 5 (data is not provided) shows the distribution of the study sample according to socio-demographic and working life-related variables.

The study sample consisted of 97 employees, 44 of whom were female (45.4%) and 53 were male (54.6%). In terms of education level, 5.2% of the employees are high school graduates, 72.2% are college+faculty graduates and 22.7% are graduate+doctoral graduates. The age range of the employees is 24-49 years and the average age is  $35.29 \pm 5.78$  years.

The average working life of the employees is  $12.47 \pm 6.25$  years (range 2-45), his active service period is  $6.55 \pm 4.51$  years (range 1-19), total sales experience period of  $4.02 \pm 5.21$  years (range 0-19), and the total duration of CRM use in professional life is  $7.45 \pm 4.53$  years (range 1-20). In terms of working type; 59.8% of the employees actively sell in their current

professional life, while 40.2% do not actively sell.

Table 6 (data is not provided) presents the distribution of the participating companies in the study sample according to their fields of activity.

A total of 97 volunteer employees from 64 companies using CRM participated in the study.

Manufacturing (41.2%), automotive (16.5%), energy (8.2%) and IT/telecommunications (8.2%) are among the top 3 sectors with the highest participation; travel and transportation (6.2%) ranked 4th; retail (4.1%), healthcare (4.1%) and textile (4.1%) ranked 5th; wholesale (3.1%) is in the 6th place. The companies that took the last place with the least participation in the study were determined as durable consumer goods (1%), foreign trade (1%), construction (1%) and tourism sector (1%).

### **6.3 Data and Collection**

The study data was collected by Perlego Research Consultancy Marketing Services Limited Company by an experienced interviewer using the telephone survey method.

The questionnaire consists of two parts;

- Part One: It includes the variables of “Socio Demographic and Working Life”.
- Part Two: It includes the scales of “CRM System Usage Effectiveness”, “Customer Performance”, “CRM System Usage Sales Process Effectiveness” and “Customer Satisfaction”.

In the first part; the socio-demographic (gender, age, education level) and working life characteristics of the participants (the field in which the company operates, the position in the company, the length of service in the current position, the total sales experience, the total working time, the CRM usage time) are questioned. The gender of the participants was measured as the classifier (Nominal) variable (Female/Male), the age as the continuous variable (Year), and the education level as the ordinal variable (Primary/Middle School, High School, High School/Faculty, Master/PhD). The field of activity of the company where the participants work (IT&Telecommunications, Energy, Food, Construction, Metal Casting Processing, Automotive, Retail, Petroleum Derivatives, Production&Distribution, Travel&Transport, Healthcare, Textile, Tourism and Other) and their role in the company (General Manager, Sales Director, Sales Manager, Sales Specialist/Representative, Key Account Manager, Business Development, Sales Operation, Marketing and Other)

were determined by multiple choice questions. Service time in his current position, total sales experience time, total working time, CRM usage time are measured as continuous variables (Years).

In the second part; there are scales that evaluate the participants' perceptions and attitudes towards the effectiveness of CRM system usage, customer satisfaction, customer performance, and sales process effectiveness of CRM usage.

## 6.4 Data Analysis and Interpretation

IBM SPSS version 25.0 statistical package program was used in the analysis of the data and the significance level was accepted as 0.05.

In data analysis, the study was evaluated and interpreted by using descriptive, bivariate and multivariate statistical methods. In the item analysis performed according to the classical test theory; the criteria for the item-total score correlation coefficient to be positive and at least 0.20, the item-total score correlation coefficient not exceeding 0.90, the alpha coefficient not increasing when the item is deleted, and the item-total score correlation coefficients not being negative were taken into consideration.

Cronbach's alpha coefficient and test-retest reliability coefficient were used for scale reliability analysis, which is defined as "the ability of the measurement tool to give similar and stable results in separate measurements, and the degree to which similar findings are obtained when the research is repeated". Cronbach's alpha coefficient was used to test the internal consistency and homogeneity of the scale (Fitzpatrick et al., 1998, p.23). Test-retest reliability coefficient (ICC) was used to evaluate its reproducibility (Cicchetti, 1994, p.286). A Cronbach's alpha value between 0.70-0.90 (Tavakol & Dennick, 2011, p.54), and an ICC value of  $\geq 0.75$  were interpreted as acceptable for scale reliability (Cicchetti, 1994, p.286).

Whether the data fit the normal distribution or not; the decision was made considering the Kolmogorov-Smirnov and Shapiro-Wilk test results Table 13 (data is not provided), the kurtosis-skewness values being in the range of -1 to +1, the Q-Q and P-P Plot graphs being on the normal distribution axis, the Histogram graph being on the normal distribution curve.

When the test results and the kurtosis-skewness Table 12 (data is not provided), normal distribution curves in the P-P Plot and Histogram are taken into account, "CRM System Usage Efficiency Scale" and "CRM System Usage Sales Process Efficiency Scale" show normal distribution, "Customer Performance Scale" and "Customer Satisfaction Scale" scores,

on the other hand, did not follow the normal distribution Graph 1-4 (data is not provided).

## **7. Findings and Comments**

### **7.1 Findings**

#### **7.1.1 Distribution of Study Sample by Socio-Demographic and Working Life Variables**

Table 5 in the “research model” subheading of the method section of the thesis shows that the study sample consisted of 97 employees, 44 of whom were female (45.4%) and 53 were male (54.6%). In terms of education level, 5.2% of the employees are high school graduates, 72.2% are college+faculty graduates, and 22.7% are postgraduate+doctoral graduates. The age range of the employees is 24-49 years and the average age is  $35.29 \pm 5.78$  years.

The average working life of the employees is  $12.47 \pm 6.25$  years (range 2-45), his active service period is  $6.55 \pm 4.51$  years (range 1-19); total sales experience period is  $4.02 \pm 5.21$  years (range 0-19) and total CRM usage period in professional life is  $7.45 \pm 4.53$  years (range 1-20). In terms of working type, 59.8% of the employees actively sell in their current professional life, while 40.2% do not actively sell.

In the Table 6, which is located in the “research model” sub-title of the method section of the thesis, among the first 3 sectors that participated in the study the most among 64 companies using CRM, manufacturing (41.2%), automotive (16.5%), energy (8,2%) and IT/telecommunications (8.2%); travel and transportation (6.2%) ranked 4th; retail (4.1%), healthcare (4.1%) and textile (4.1%) ranked 5th; it is seen that wholesale (3.1%) takes the 6th place. The fields of companies that are in the last place with the least participation in the study are listed as durable consumer goods (1%), foreign trade (1%), construction (1%) and tourism sector (1%). Respondents to the survey interview were sales, marketing, customer relations and other relevant employees using CRM.

#### **7.1.2 Descriptive Statistics and Reliability Analysis of the Scales Used in the Study**

Table 14 (data is not provided) shows the descriptive statistics of the scales used in the study and the scale scores. The average score of the 8-item “CRM System Use Efficiency Scale” with a score range of 17-40 was  $31,43 \pm 4,83$ , with a median value of 32; 3-item “Customer Performance Scale” with a score range of 6-15, average score of  $13,35 \pm 1,88$ , median



value of 14; the average score of the 7-item “CRM System Usage Sales Process Efficiency Scale” with a score range of 15-35 was  $20,23 \pm 4,01$ , the median value was 26; and the 5-item “Customer Satisfaction Scale” with a score range of 6-25, average score was  $20,23 \pm 4,01$ , and the median value was 20.

The reliability coefficients (Cronbach’s alpha), which are the indicators of the internal consistency of the scales; it is seen that it is 0,772 for the “CRM System Usage Effectiveness Scale”, 0,812 for the “Customer Performance Scale”, 0,807 for the “CRM System Usage Sales Process Efficiency Scale”, and 0,906 for the “Customer Satisfaction Scale”. These values prove that the internal consistency and homogeneity of the scales used in the study show an acceptable value and that the scales are reliable Table 14.

Table 15 (data is not provided) shows that the item total-score correlation values of the “CRM System Use Efficiency Scale” vary between 0,268 and 0,653. The Cronbach’s alpha values were examined when the item was removed, it was found that the removal of any of the scale items did not exceed the scale Cronbach’s alpha value of 0,772 and there was no need to remove the item from the scale.

“Customer Performance Scale” item total-score correlation values ranged between 0.648 and 0.679. When the Cronbach’s alpha values were examined as the item was removed, it was found that the removal of any of the scale items did not exceed the scale’s Cronbach’s alpha value of 0.812 and there was no need to remove the item from the scale Table 16 (data is not provided).

Sales Process Effectiveness Scale” item total-score correlation values ranged between 0.417 and 0.591. When the Cronbach’s alpha values were examined when the item was removed, it was found that the removal of any of the scale items did not exceed the scale’s Cronbach’s alpha value of 0.807 and there was no need to remove the item from the scale Table 17 (data is not provided).

The item-total-score correlation values of the “Customer Satisfaction Scale” ranged from 0.631 to 0.826. When the Cronbach’s alpha values were examined when the item was removed, it was found that the removal of any of the scale items did not exceed the scale’s Cronbach’s alpha value of 0.906 and there was no need to remove the item from the scale Table 18 (data is not provided).

95% confidence interval ICC values and test-retest reliability coefficients of the scales:

ICC=0.904 (95% confidence interval 0.755-0.964) for the “CRM



System Usage Efficiency Scale”; ICC=0.835 (95% confidence interval 0.601-0.937) for the “Customer Performance Scale”; for “CRM System Usage Sales Process Efficiency Scale”, ICC=0.927 (95% confidence interval 0.810-0.973); and ICC=0.873 (95% confidence interval 0.684-0.952) for the “Customer Satisfaction Scale” were found. These values are above the acceptable value  $\geq 0.75$  and show that the repeatability of the scales is excellent.

In Table 19 (data is not provided), it is seen that there is a moderately significant positive correlation between the scales and the correlation coefficients vary between 0.371 and 0.441. Significant correlation values between the scales in the conceptual model show the construct validity of the scales (Ercan & Kan, 2004, p.215).

When the relationship between “CRM System Usage Efficiency Scale” and socio-demographic variables were examined, a low level of significant negative correlation was found only with age ( $r_s = -0.243$ ;  $p < 0.05$ ). Young employees scored higher on the “CRM System Usage Effectiveness Scale”. No statistically significant relationship was found between the other scales used in the study and socio-demographic variables ( $p > 0.05$ ). When the relations between the scales used in the study and the variables of working life are examined; a low level of significant positive correlation ( $r_s = 0.243$ ;  $p < 0.05$ ) was found between the “CRM System Usage Efficiency Scale” and the duration of CRM usage. As the duration of CRM usage increases, the scores obtained from the “CRM System Usage Effectiveness Scale” increase. Significant statistical relationships were found between “CRM System Usage Sales Process Efficiency Scale” scores and working type ( $p = 0.002$ ) and total sales experience in business life ( $r_s = 0.302$ ;  $p < 0.01$ ). Those who make active sales and those who have a longer total sales time in business life received higher points in the “CRM System Usage Sales Process Effectiveness Scale” than those who do not make sales and those who have less total sales time in business life Table 20 (data is not provided).

In Table 21 (data is not provided), “CRM System Usage Effectiveness Scale”; it is seen that there is a significant gender difference in the item scores of “I see myself as an intensive user of my company’s CRM system” ( $p = 0.040$ ) and “I convert new company products into sales very quickly” ( $p = 0.022$ ). Compared to men, women scored higher on the item “I see myself as an intensive user of my company’s CRM system”, and men scored higher on the item “I convert new company products into sales very quickly” compared to women. A significant difference was found in terms of education level ( $p = 0.035$ ) in the scores of the item “I fully integrated the CRM application into my sales process”. College/Faculty Graduates reported that they “integrated the CRM application into their sales

processes” more than those with Masters/Doctorate graduates. With age, the items “I fully integrated the CRM application into my sales process” ( $r=-0.226$ ;  $p<0.05$ ) and “CRM helps me shorten my sales process” ( $r=-0.221$ ;  $p<0.05$ ) were at low levels, significant negative correlation was found. Employees in the older age group integrate the CRM application into the sales process less and think that CRM does not shorten the sales process.

In the “CRM System Usage Effectiveness Scale”; A significant difference was found in terms of working type in the item score of “I convert new company products into sales very quickly” ( $p=0.004$ ). Active sellers reported that they “Converts new company products into sales very quickly” compared to not making sales. Those who have more total sales experience in business life consider themselves less “intensive CRM system users” ( $r=-0.215$ ;  $p<0.05$ ) compared to those who do not, those who have more total sales experience in business life more “CRM helps to shorten the sales process” than those who do not ( $r=0.202$ ;  $p<0.05$ ), and “Converts new company products into quick sales” ( $r=0.419$ ;  $p<0.01$ ). Employees with more CRM usage time compared to employees who use less CRM more “Use the CRM system extensively to do their job” ( $r=0.210$ ;  $p<0.05$ ), “The use of CRM enables them to better understand the needs of their customers” ( $r=0.205$ ;  $p<0.05$ ) and reported that “The use of CRM enables to manage complex customer relations” ( $r=0.257$ ;  $p<0.05$ ) Table 22 (data is not provided).

Table 23 (data is not provided) shows that there is no significant difference in the item scores of the “Customer Performance Scale” in terms of socio-demographic variables ( $p>0.05$ ).

Table 24 (data is not provided) shows that there is no significant difference in the item scores of the “Customer Performance Scale” in terms of factors related to working life ( $p>0.05$ ).

Table 25 (data is not provided) shows that there is no significant difference in the item scores of the “CRM System Usage Sales Process Effectiveness Scale” in terms of socio-demographic variables ( $p>0.05$ ).

In the “CRM System Usage Sales Process Effectiveness Scale”; “My usage of the CRM system allows me to analyze the expectation of the order amount on a monthly, quarterly and annual basis” ( $p=0.003$ ), “My usage of the CRM system helps me convert potential customers into real customers” ( $p=0.017$ ), “My usage of the CRM system provides the opportunity to analyze the reasons why opportunities are won and lost.” ( $p<0.001$ ) and “Using the CRM system allows me to know my competitors” ( $p=0.036$ ), a significant difference was found in terms of work type. Active sellers scored significantly higher on these items than those without sales

experience ( $p < 0.05$ ). With the total sales experience period in business life, “My usage of the CRM system allows me to analyze the expectation of the order amount on a monthly, quarterly and annual basis” ( $r = 0.313$ ;  $p < 0.01$ ), “My usage of the CRM system increases my sales process closing rates” ( $r = 0.248$ ;  $p < 0.05$ ), “My usage of CRM system helps me convert potential customers into real customers” ( $r = 0.243$ ;  $p < 0.05$ ) and “My usage of CRM system provides the opportunity to analyze the reasons for winning and losing opportunities” ( $r = 0.247$ ;  $p < 0.05$ ), there was a significant positive correlation among the items, varying between low and moderate levels. A low level of significant positive correlation was found between the duration of CRM usage and the item score “Helps increase profitability while reducing customer service cost” ( $r = 0.258$ ;  $p < 0.05$ ) Table 26 (data is not provided).

No significant difference was found in the item scores of the “Scale of the Contribution of the Usage of the CRM System to Customer Satisfaction” in terms of socio-demographic variables ( $p > 0.05$ ) Table 27 (data is not provided).

There was no significant difference in terms of work type in the items of the “Customer Satisfaction Scale” ( $p > 0.05$ ). A low level of significant positive correlation was found between the duration of using the CRM system and the item scores of “Helps to retain customers” ( $r = 0.202$ ;  $p < 0.05$ ) and “Increases customer loyalty” ( $r = 0.221$ ;  $p < 0.05$ ) Table 28 (data is not provided).

Table 29 (data is not provided) shows that the linear regression model in which the relationship between CRM system usage and customer satisfaction is tested is significant ( $F = 19.067$ ;  $p < 0.001$ ). The use of the CRM system alone explains 15.8% (Adjusted  $R^2 = 0.158$ ) of the total variance in customer satisfaction. The usage of CRM system significantly increases customer satisfaction ( $\beta = 0.409$ ;  $p < 0.001$ ). With these findings, hypothesis H3 was accepted.

In the hierarchical linear regression analysis in which the relationships between CRM system usage efficiency, customer satisfaction and customer performance were tested in Table 30, Model 1 ( $F = 10.967$ ;  $p = 0.001$ ), Model 2 ( $F = 28.428$ ;  $p < 0.001$ ) and Model 3 ( $F = 15.603$ ;  $p < 0.001$ ) it is seen that is statistically significant. In Model 1; CRM system usage efficiency alone explains 9.4% (Adjusted  $R^2 = 0.094$ ) of the total variance in customer performance. The efficiency of using the CRM system significantly increases customer performance ( $\beta = 0.322$ ;  $p = 0.001$ ). In Model 2; customer satisfaction alone was a positive predictor explaining 22.2% (Adjusted  $R^2 = 0.222$ ) of the total variance of customer performance ( $\beta = 0.480$ ;  $p < 0.001$ ). In Model 3; CRM system usage efficiency and

customer satisfaction together explain 23.3% (Adjusted R<sup>2</sup>=0.233) of the total variance of customer performance. In Model 3, the effect of CRM system usage efficiency on customer performance was found to be statistically insignificant ( $\beta=1.539$ ;  $p=0.127$ ). The Sobel test shows that customer satisfaction is an intermediate variable in the relationship between CRM usage efficiency and customer performance (Sobel test statistics=3.37512178;  $p=0.00073783$ ). With these findings, the H1 and H4 hypotheses were confirmed.

In the hierarchical linear regression analysis in which the relationship among CRM system usage efficiency, customer satisfaction and sales process efficiency were tested in Table 31, Model 1 ( $F=22,946$ ;  $p<0.001$ ) and Model 2 ( $F=23.405$ ;  $p<0.001$ ) and Model 3 ( $F=18.133$ ;  $p<0.001$ ) are statistically significant. In Model 1; the efficiency of using the CRM system alone explains 18.6% (Adjusted R<sup>2</sup>=0.186) of the total variance of sales process efficiency. The efficiency of using the CRM system significantly increases the efficiency of the sales process ( $\beta=0.441$ ;  $p<0.001$ ). In Model 2; customer satisfaction alone was a positive predictor explaining 18.9% (Adjusted R<sup>2</sup>=0.189) of the total variance of sales process effectiveness ( $\beta=0.445$ ;  $p<0.001$ ). In Model 3; CRM system usage and customer satisfaction together explain 26.3% (Adjusted R<sup>2</sup>=0.263) of the total variance of customer performance. In the model, it is seen that the independent variables of CRM system usage efficiency ( $\beta=3.243$ ;  $p=0.002$ ) and customer satisfaction ( $\beta=3.305$ ;  $p=0.001$ ) together have a statistically significant positive effect on sales process efficiency. In the context of these findings, the H2 and H5 hypotheses were confirmed.

In the hierarchical linear regression analysis seen in Table 32 (data is not provided); at the first stage, among the research model concepts entered into the model, only sales process efficiency was found to be an important positive determinant ( $\beta=0.335$ ;  $p=0.001$ ), which explained 25.4% (Adjusted R<sup>2</sup>=0.254) of the total variance of CRM usage efficiency. In the second stage, when the scales measuring research model concepts and socio-demographic variables were entered into the model together, sales process effectiveness ( $\beta=0.331$ ;  $p=0.001$ ) and age ( $\beta=-0.182$ ;  $p=0.041$ ) together, it was determined that was significant determinants explaining of CRM usage efficiency total variances was 28.9% (Adjusted R<sup>2</sup>=0.289). Increasing sales process efficiency and decreasing age were found to be important determinants of CRM usage effectiveness. At this stage, it is seen that age alone, one of the socio-demographic variables, explains 5.6% (R<sup>2</sup> change=0.056) of the total variance of CRM usage effectiveness. In the third stage, when the scales measuring research model concepts, socio-demographic and all independent variables related to working life were entered into the model, sales process efficiency ( $\beta=0.310$ ;  $p=0.005$ ), age

( $\beta=-0.266$ ;  $p=0.044$ ) and duration of CRM usage ( $\beta=0.227$ ;  $p=0.034$ ) were found the most important determinants of CRM system usage efficiency. These three determinants explain 31% (Adjusted  $R^2=0.310$ ) of the total variance of CRM system usage efficiency. The CRM usage time independent variable, which is related to working life, alone explains 5.6% ( $R^2$  change= $0.056$ ) of the total variance of CRM system usage efficiency.

## 7.2 Comments

Within the scope of the effects of the usage of CRM on company performance in companies in the B2B area, the impact on customer satisfaction (Ata, 2008, p.146) and on the other hand, on the performance of sales professionals and cooperation with other units (Rodriguez and Honeycutt, 2011, p.354) is a conceptual study investigated using the working model.

In this study, the research population was consisted of Turkey's 500 largest companies in a wider and different industrial context, both in B2B and B2C business areas. For this reason, after carefully reviewing the scales called "CRM Usage Scale", "Customer Satisfaction Scale", "Performance Scale with Customer" and "Sales Process Efficiency Scale", which are used in studies conducted in companies in the B2B sector in line with expert group opinions, and appropriate scales were developed in line with expert group recommendations using deductive and inductive methods. Psychometric reliability analyzes were performed. At this stage, the study "Good Practices for Scale Development and Reliability in Health, Social and Behavioral Fields" published by Boateng et al. (Boateng et al., 2018, p.2) was taken into account.

Cronbach's alpha reliability coefficients (Cronbach alpha= $0.772-0.906$ ) (Fitzpatrick et al., 1998, p.23), which are indicators of the internal consistency of the scales used in the study, and test-retest reliability coefficients (ICC= $0.835-0.927$ ), which is an indicator of repeatability (Cicchetti, 1994, p.286) is above the acceptable values. These values show that the scales used in the study are a reliable psychometric tool in measuring related areas.

When the scales used while developing the item pool were compared with the scale reliability numbers we developed for this study; the Cronbach alpha (Cronbach alpha =  $0.906$ ) of the "Customer Satisfaction Scale" is higher than the "Customer Satisfaction Scale" (Cronbach alpha =  $0.856$ ) developed by Ata (Ata, 2008, p.159); the reliability coefficients of "CRM System Usage Efficiency Scale", "Customer Performance Scale", and "CRM System Usage Sales Process Efficiency Scale" used in our study were found slightly lower than the original scales used in Rodriguez and Honeycutt's (Rodriguez and Honeycutt, 2011, p.353) study.

Only the Cronbach's alpha values, which are the internal consistency coefficients, of these scales used in the studies of Ata (Ata, 2008, p.159) and Rodriguez and Honeycutt (Rodriguez and Honeycutt, 2011, p.353) were examined, and test-retest reliability was not examined. The fact that a measurement tool gives the same measurement results when applied at certain time intervals is an important indicator of its repeatability.

In the study, linear and hierarchical regression analysis were used to test the conceptual model and to examine the effects of working life and socio-demographic factors on the effectiveness of CRM use. These statistical analysis methods were also used in pioneering studies on the usage of CRM in demonstrating the mediating effect and testing hypotheses (Ata, 2008, p.159; Rodriguez & Honeycutt, 2011, p.353). Our study is the first to investigate the effects of socio-demographic and work-related factors on both the item level and the scale total score and examine whether these factors are an indicator of the effectiveness of CRM use.

According to the results of the bivariate analysis used in our study, significant differences were found on the total scores and item scores of the scales other than the "Customer Performance Scale" in terms of socio-demographic and working life-related factors.

It is seen that there is a significant difference in terms of gender in the effectiveness of the usage of the CRM system. While women see themselves as an intensive user of the company's CRM system compared to men, men state that they are more active in converting the company's new products into sales very quickly compared to women.

It is seen that there is a significant difference in terms of education level and age regarding the full integration of the usage of the CRM system into sales processes. College/Faculty graduates seem to use their sales processes more integrated with the CRM system than Master/Doctorate graduates. It has been determined that employees in the older age group less integrate the CRM application into the sales process.

It is seen that the total sales experience period in business life has a positive effect on the "Effectiveness of using the CRM system" in terms of shortening the sales processes of the usage of the CRM system and quickly converting the company's new products into sales.

Total sales experience in business life has a positive effect on analyzing periodic order planning in sales, increasing sales process closing rates, helping to convert potential customers into real customers, and enabling the analysis of the reasons for gaining or losing opportunities with the usage of the CRM system.



As the efficiency of the sales process increases, so does the efficiency of using the CRM system.

The efficiency of using the CRM system was found to be higher among the employees who are younger and have a longer CRM usage period. Employees with a high CRM usage period report that they use a more comprehensive CRM system than employees with less CRM usage time, that the usage of CRM enables them to better be understanding the needs of their customers and enables them to manage complex customer relations. Those who have long CRM usage period than short usage period report that at higher level “the usage of CRM reduces the cost of customer service and helps increase profitability”.

In terms of customer satisfaction, the longer the CRM system usage time, employees report that higher level “the usage of the CRM system helps customer retention and increases customer loyalty.”

Significant statistical relationships were found between the usage of CRM system and sales process effectiveness scale scores, and type of work and total sales experience in business life.

CRM system sales process activities of those who make active sales and those who have a longer total sales time in business life were also found to be higher. Employees with more total sales experience in their business life state that “CRM helps shorten the sales process” and “converts new company products into sales very quickly”, although they see themselves as less “intensive CRM system users”. Active salespeople report that “the use of a CRM system enables them to analyze monthly, quarterly and annual order amount expectation, convert potential customers into real customers, analyze the reasons for gaining and losing opportunities, and getting to know their competitors” at a higher level than those without sales experience. Employees who have more total sales experience in business life are more likely to “analyze the monthly, quarterly and annual order amount expectation of the use of CRM system, increase sales process closing rates, convert potential customers into real customers, and analyze the reasons for gaining and losing opportunities. provides the opportunity”.

According to the results of the multivariate analyzes used in the study; when all independent variables are taken into account, sales process efficiency, CRM usage period and age factors, which are components of sales performance, were found to be the most important indicators of CRM system usage efficiency.

When we interpret the relationships between CRM usage efficiency and the two components of sales performance, it is seen that customer satisfaction has a mediating effect on the relationship between CRM

usage and customer performance; it has been determined that customer satisfaction has a direct effect on the relationship between the usage of CRM and the effectiveness of the sales process.

It is seen that the efficiency of using the CRM system is an indicator of customer satisfaction and customer performance. In addition, it has been determined that customer satisfaction is an important predictor of customer performance. At the same time, it has been found that customer satisfaction plays a full mediating role in the relationship between CRM usage efficiency and customer performance.

It is seen that CRM system usage efficiency and customer satisfaction are important predictors of sales process efficiency together, but it does not support the assumption that customer satisfaction plays a mediating role between CRM usage and sales process effectiveness.

It has been observed that the usage of the CRM system significantly increases customer satisfaction, as in the studies of Ata (2008) and Gültekin and Kemet (2018). The effectiveness of usage of the CRM system significantly increases customer performance, as in the studies of Rodriguez and Honeycutt (2011). It shows that customer satisfaction is the perfect intermediate variable in the relationship between CRM usage efficiency and customer performance.

The efficiency of using the CRM system significantly increases the efficiency of the sales process. It is seen that the effectiveness of the usage of the CRM system and customer satisfaction, together with the independent variables, have a statistically significant positive effect on the efficiency of the sales process.

When the scales evaluating the concepts in the research model, socio-demographic, and all independent variables related to working life were entered into the model, sales process effectiveness, age and CRM usage period were found to be the most important determinants of CRM system usage efficiency. Detection of age and period of CRM usage as an important indicator in multiple analyzes, among the socio-demographic and working life-related factors determined in dual analyzes; it will be beneficial to take these factors into account and integrate them into the conceptual model of the study in new studies to be planned.

## **9. Conclusion**

### **9.1 Summary**

In this study, the effect of the usage of CRM in B2B and B2C business areas on the customer satisfaction of companies and the sales performance



of sales professionals were researched and evaluated within the scope of companies defined as Turkey's largest 500 companies (Fortune 500).

Face-to-face meetings could not be held due to the fact that most of the companies work from home and restrictions on access to the working environment during the Coronavirus pandemic conditions. In our country, Fortune 500 companies were accepted as the research population and those using CRM from these companies were determined by random sampling. During the Coronavirus pandemic period, support was received from a professional research company during sample determination, data collection and analysis. In the study, an experienced and trained practitioner working in a survey research company that includes the variables of "Socio-Demographic and Work Life" and the scales of "CRM System Usage Efficiency", "Customer Performance", "CRM System Usage Sales Process Efficiency" and "Customer Satisfaction" collected by telephone survey method.

In this study, which is a conceptual model, "CRM System Usage Efficiency Scale", "Customer Satisfaction Scale", "Customer Performance Scale" to measure the infrastructures of CRM usage, customer satisfaction and sales performance -sales process efficiency and performance with customers-, "CRM System Usage Sales Process Efficiency Scale" was developed. Considering the publication of Boateng et al. (Boateng et al., 2018, p.2) titled "Good Practices for Scale Development and Reliability in Health, Social and Behavioral Fields", deductive and inductive methods were used in the creation of the item pools of the scales and their reliability was tested.

The Cronbach's alpha values, which indicate the internal consistency and homogeneity of our scales, vary between 0.772 and 0.906, and the test-retest reliability coefficients, which indicate the reproducibility, range between 0.835 and 0.927. These values are in the range of acceptable values and prove that the scales are reliable.

In bilateral analyzes, it is seen that education level, which is one of the socio-demographic factors, does not have a significant effect on the effectiveness of CRM usage. Although the efficiency of using CRM among younger employees is higher than that of older employees, it is determined that the usage of CRM decreases with advancing age.

In bilateral analyzes where factors related to working life are taken into account; it is seen that as the duration of CRM usage increases, the effectiveness of CRM usage also increases. Opportunities to experience the active effect of CRM usage on the sales process should be increased by providing trainings on the usage of CRM and encouraging company employees from the beginning of their employment.

Multivariable analysis methods were used to test the infrastructure relationships between the usage of CRM, customer satisfaction and sales performance -sales process efficiency and performance with the customer- in the conceptual model of the study. When the hypothesis between CRM system usage and customer satisfaction is tested; it has been determined that the usage of the CRM system alone significantly increases customer satisfaction. When we tested the relationships with customer performance between the efficiency of using the CRM system and customer satisfaction, it was seen that CRM system usage efficiency and customer satisfaction increased customer performance significantly when evaluated alone, but when CRM system usage efficiency and customer satisfaction were examined together, there was no significant effect on customer performance. Whether customer satisfaction is an intermediate variable in the relationship between CRM usage efficiency and customer performance has been tested with the Sobel test and proven to play a mediating role. With the determination of these relations, the hypotheses of “Using CRM increases the performance with customers” (H1) and “Customer satisfaction positively affects the increase in performance with customers” (H4) were confirmed.

When we test the relationships among CRM system usage efficiency, customer satisfaction and sales process efficiency; considering the effectiveness of the usage of the CRM system and customer satisfaction alone, it was seen that there was no intermediary predictor in this relationship, which increased the efficiency of the sales process. The effectiveness of CRM system usage and customer satisfaction, together were found to be important predictor, explaining more than 1/4 of the total variance of customer performance and “The usage of CRM increases the efficiency of the sales process” (H2) and “Customer satisfaction positively affects the increase of the sales process efficiency” (H5) hypotheses are confirmed.

When the factors that affect success in the implementation phase of CRM, which are classified as people, processes, and technology, are reviewed, the importance levels in customer relationship management are classified as 50% human, 30% process and 20% technology (Kaya, 2016). In this context, in the hierarchical linear regression analysis that we conducted by taking into account all the subjective evaluations such as customer performance, customer satisfaction and sales process performance effectiveness used in the study, with the socio-demographic and working life-related variables of the employees, sales process effectiveness, age and CRM usage period were found to be an important indicator effective in CRM usage effectiveness. These variables explain 31% of the total variance in CRM usage efficiency.

In this study, which was carried out using scales with proven reliability, it was determined that as the positively increasing attitudes of employees towards the effectiveness of CRM use in the sales process, the effectiveness of CRM usage in their professional life also increases. The effectiveness of CRM usage decreases with advancing age, and the effectiveness of CRM usage increases as the duration of CRM usage increases. These findings will contribute to the human resources departments of companies in identifying priority employees who need training and whose effectiveness in using CRM should be increased.

As the effectiveness of CRM usage increases, customer performance also increases. Customer satisfaction has a mediating effect on this increase. It is seen that customer satisfaction does not have a mediating role in the relationship between CRM usage efficiency and sales process efficiency, but has a direct effect. This finding shows that the important determinants of sales process effectiveness are customer satisfaction and CRM usage efficiency.

It is seen that customer satisfaction does not have an intermediary role between CRM usage efficiency and sales efficiency, but it has an intermediary effect between CRM usage and customer performance.

In studies to increase the effectiveness of CRM usage, it is necessary to take into account the socio-demographic and working life-related factors of the employees, as well as the awareness and attitudes of the employees towards the effectiveness of the CRM usage in customer performance, satisfaction, and sales process.

Our study is the first in which CRM usage efficiency of employees in both B2B and B2C business field is evaluated as a conceptual model. It can be generalized that the mediator effect of customer satisfaction between CRM usage efficiency and customer performance and other factors affecting CRM usage efficiency will be investigated, but it will guide new studies to be conducted in large samples.

## **9.2 Judgment**

This study contributes to the existing literature studies by looking at the effects of CRM on customer satisfaction and performance of salespeople in B2B and B2C business sectors, in terms of adaptation of existing concepts and with new variables, and the effects of CRM in companies covered by both business areas.

In addition to the importance of understanding how technology is used and accepted today, our study reveals that the usage of CRM has a positive effect on both the satisfaction of its customers, which is of critical importance for companies, and the sales performance of its own employees.

### 9.3 Recommendations

In this study, the effect of CRM on customer satisfaction and sales performance of sales professionals in companies providing B2B and B2C business areas, was determined by a new conceptual model, which was selected by random sampling from Turkey's largest 500 companies (Fortune 500) and used CRM. It has been extensively researched and evaluated in the research sample consisting of company employees operating in marketing, sales, and related fields.

The generalizability and accuracy of the results obtained from our study can be tested in new studies to be planned in the B2B and B2C sectors in Turkey, and it can be aimed to obtain information specific to these business areas. In addition, a comparative study between B2B and B2C sectors can be investigated the effects of CRM on customer satisfaction and sales performance of sales professionals.

On the other hand, a comparative study can be planned in companies in the B2B and B2C sectors with and without CRM, so that the customer satisfaction and sales performance of the companies can be compared. While planning these studies, the company's ability to use the CRM system and its strategy should be taken into account.

Our study can contribute to the planning of new studies that can be applied in different service areas such as education, finance, food, communication, construction, media, automotive, health, textile, tourism in the B2B and B2C sectors and to make comparisons on the basis of certain sectors. The limitation that the majority of companies in all specified sectors will have and actively use a CRM system should be taken into account.

The scales with proven reliability used in this study can be used by the human resources department of the companies to determine the training needs of the company employees, who provide services in different areas in the B2B and B2C sectors, by detecting the awareness of the usage of CRM, customer satisfaction and sales performance. The scales used in the study can be chosen as a reliable measurement tool in the planning of new experimental studies in which the effectiveness of the training given to the employees on the usage of CRM, customer satisfaction and sales performance by companies will be evaluated.

This study can guide new studies that will investigate the effects of classical-CRM and mobile

-CRM use on the customer satisfaction of companies and the sales performance of sales professionals, taking into account the conditions in

business life, which has been shaped by the Coronavirus pandemic and defined as the new normal.

New studies can be planned, covering companies that offer e-commerce services in B2B and B2C business areas, whose sales performance has increased and will continue to increase during the Coronavirus pandemic period. While planning these studies, the limitation that companies have a CRM system and actively engage in e-commerce should be taken into account.

In new studies to be conducted in this area, taking into account the factors of the company as well as the socio-demographic and working life variables of the employees who make up the study sample will contribute to the evaluation of the results and relations.

As a result, this study is one of the first studies based on a conceptual model that investigates the effect of CRM, which is used by most companies in the B2B and B2C sectors, on the customer satisfaction of companies and the sales performance of sales professionals. Considering the results of the study and its conceptual model, academic studies in which the effectiveness and determinants of the use of CRM in different service sectors will be evaluated and the model will be developed with new parameters. It will contribute to the company managers in planning the employee trainings to be planned in professional business life and determining the training needs for the employees, taking into account the socio-demographic and working life-related factors of the employees. It will guide researchers in new studies aiming to develop a conceptual model that will test the intermediary role played by customer satisfaction in the relationship between CRM usage efficiency and customer performance.

In this study, in which the subjective evaluations of employees regarding customer satisfaction, customer and sales process effectiveness, and socio-demographic and working life-related variables are taken into account, sales process effectiveness, age and CRM usage time are important indicators that do not explain 31% of the total variance in CRM usage efficiency found. As Kaya (2016) emphasized in his study, planning new studies that take into account the process and technology usage factors of companies other than the human factor that affects the success in CRM usage efficiency will help determine other predictors of CRM usage efficiency.

## REFERENCES

- Peker, E. & Kırdar, Y. (2021). Customer Relationship Management's Impact On Customer Satisfaction And Sales Professionals' Sales Performance: Turkey's Top 500 Companies. Doctoral thesis was verbally presented at 2nd International Media and Society Symposium-MASS Conference at Istinye University on 26-27 May, 2022
- Ahearne, M. & Rapp, A. (2010). The Role of Technology at the Interface Between Salespeople and Consumers. *Journal of Personal Selling & Sales Management*, 30(2). 111-120
- Akalın, Ş. (2005). *Satış Personeline Yönelik Performans Değerlendirme Ölçeği Geliştirilmesi ve Psikometrik Özelliklerinin Belirlenmesi*. (Yayımlanmamış Yüksek Lisans Tezi). Ankara Üniversitesi, Eğitim Bilimleri Enstitüsü, Eğitim Bilimleri Ana Bilim Dalı, Ölçme ve Değerlendirme (Psikometri) Programı. Ankara
- Anderson, E. W., Fornell, C. & Lehmann, D. R. (1994). Customer Satisfaction, Market Share, and Profitability: Findings from Sweden. *Journal of Marketing*, 58(July). 53-66
- Ata, U. Z. (2008). *The Effect of Customer Relationship Management Adoption on Organizational Performance in Business-to-Business Setting*. (Unpublished Doctoral dissertation). Available from The Council of Higher Education (YÖK) National Theses Center (Thesis no: 231906)
- Avlonitis, G. J. & Panagopoulos, N. G. (2005). Antecedents and Consequences of CRM Technology Acceptance in the Sales Force. *Industrial Marketing Management*, 34(May). 355-368
- Boateng, G. O., Neilands, T. B., Frongillo, E. A., Melgar-Quiñonez, H. R., & Young, S. L. (2018). Best Practices for Developing and Validating Scales for Health, Social, and Behavioral Research: A Primer. *Frontiers in Public Health*, 6 (149). 1-18
- Cannon, J. P. & Perreault Jr., W. D. (1999). Buyer-Seller Relationships in Business Markets. *Journal of Marketing Research*, 36(4). 439-460
- Chen, I. & Popovich, K. (2003). Understanding Customer Relationship Management (CRM). People, Process and Technology. *Business Process Management Journal*, 9(5). 672-688
- Cicchetti, D. V. (1994). Guidelines, Criteria, and Rules of Thumb for Evaluating Normed and Standardized Assessment Instruments in Psychology. *Psychological Assessment*, 6(4). 284-290
- Cortez, R. M. & Johnston. W. (2020). The Coronavirus Crisis in B2B Settings: Crisis Uniqueness and Managerial Implications Based on Social Exchange Theory. *Industrial Marketing Management*, (88). 125-135

- Crosby, L. A. (2002). Exploding Some Myths about Customer Relationship Management. *Managing Service Quality*, 12(5). 271-277
- Demirbağ, E. (2004). *İşletme Yönetiminde Yeni Eğilimler Dizisi İstanbul Ticaret Odası Sorularla Müşteri İlişkileri Yönetimi*. İstanbul: Mega Ajans
- Drummond, T. (2001). Hindsight 80/20: Lessons Learned from CRM Initiatives. *Integrated Marketing Communications Research Journal*, 7 (Spring). 14-18
- Ercan, İ. & Kan, İ. (2004). Ölçeklerde Güvenirlik ve Geçerlik. *Uludağ Üniversitesi Tıp Fakültesi Dergisi*, 30 (3). 211-216
- Ersoy, N. F. (2002). Finansal Hizmetlerde CRM Kavramı. *Pazarlama Dünyası Dergisi*, 15. 5
- Fitzpatrick, R., Davey, C., Buxton, M. J. & Jones, D. R. (1998). Evaluating Patient Based Outcome Measures For Use In Clinical Trials. *Health Technology Assessment*, 2(14). 141-69
- Fornell, C. (1992). A National Customer Satisfaction Barometer: The Swedish Experience. *Journal of Marketing*, 56 (January). 6-21
- Giese, J. L. & Cote, J. A. (2002). Defining consumer satisfaction. *Academy of Marketing Science Review*, 2000(1). 1-24
- Gummesson, E. & Polese, F. (2009). B2B is not an Island. *Journal of Business & Industrial Marketing*, 24(5/6). 337-350
- Gültekin, B. & Kement, Ü. (2018). *Müşteri İlişkileri Yönetimi Temel Kavramlar ve Uygulamalar*. İstanbul: Nobel Akademik Yayıncılık
- Hassan, R. S., Nawaz, A., Lashari, M. N. & Zafar, F. (2014). Effect of Customer Relationship Management on Customer Satisfaction. 2nd Global Conference on Business, Economics, Management and Tourism. *Procedia Economics and Finance*, 23(2015). 563-567
- Hauser, J. R., Duncan I. Simester, D. I. & Wernerfelt, B. (1994). Customer Satisfaction Incentives. *Marketing Science*, 13(4). 327-350
- Hunter, G. K. & Perreault Jr., W. D. (2006). Sales Technology Orientation, Information Effectiveness and Sales Performance. *Journal of Personal Selling and Sales Management*, 26(2). 95-113
- Hunter, G. K. & Perreault Jr., W. D. (2007). Making Sales Technology Effective. *Journal of Marketing*, 71(January 2007). 16-34
- Ingram, T. N. (2004). Future Themes in Sales and Sales Management: Complexity, Collaboration and Accountability. *Journal of Marketing: Theory and Practice*, 12(4). 18-28
- Kaya, S., The Critical Aspects of CRM, [https://www.linkedin.com/pulse/critical-aspects-crm-selim-kaya?trk=portfolio\\_article-card\\_title](https://www.linkedin.com/pulse/critical-aspects-crm-selim-kaya?trk=portfolio_article-card_title), (E.T: 11.05.2020)



- Kırdar, Y & Demir, F. O. (2013). Müşteri İlişkileri Yönetimi: CRM. *Review of Social, Economic & Business Studies*, 7(8). 293-308
- Kırım, A. (2001). *Strateji ve Bire-Bir Pazarlama CRM*. İstanbul: Sistem Yayıncılık
- Kotler, P. (1997). *Marketing Management Analysis Planing, Implementation And Contral*. New Jersey: Prentice Hall Inc.
- Li, L. & Mao, J. (2012). The Effect of CRM Use on Internal Sales Management Control: An Alternative Mechanism to Realize CRM Benefits. *Information & Management*, 49 (2012). 269-277
- Liu, A. H. & Leach, M. P. (2001). Developing Loyal Customers with a Value-Adding Sales Force: Examining Customer Satisfaction and the Perceived Credibility of Consultative Salespeople. *Journal of Personal Selling & Sales Management*, 21(2). 147-156
- Mendoza, L. E, Marius, A., Perez, M. & Griman, A. C. (2007). Critical Success Factors for a Customer Relationship Management Strategy. *Information and Software Technology*. 49(2007). 913-945
- Mishra, A. & Mishra, D. (2009). Customer Relationship Management: implementation process perspective. *Acta Polytechnica Hungarica*, 6(4). 83-99
- Oliver, R. L. (1997). *Satisfaction: A Behavioral Perspective On The Consumer*. McGraw-Hill: New York
- Önce, A. G. (2015). *Satış Yönetimi*. Beta Basım Yayım Dağıtım: İstanbul
- Özdağoğlu, A., Özdağoğlu, G., & Öz, E. (2008). Müşteri Sadakatinin Sağlanmasında Müşteri İlişkileri Yönetiminin Önemi: İzmir’de Bir Hipermarket Araştırması. *Atatürk Üniversitesi İktisadi ve İdari Bilimler Dergisi*, 22(1). 367-380
- Piercy, N. F. (2010). Evolution of strategic sales organizations in business-to-business marketing. *Journal of Business & Industrial Marketing*, 25(5), 349-359
- Rigby, D., Reichheld, K., Frederick, F., & Scheffer, F. (2002). Avoid the four perils of CRM. *Harvard Business Review*, 80(2). 101-109
- Rodriguez, M. & Honeycutt, E. D. (2011). Customer Relationship Management (CRM)’s Impact on B to B Sales Professionals’ Collaboration and Sales Performance. *Journal of Business-to-Business Marketing*. 18. 335-356
- Saini, A., Grewal, R. & Johnson, J.L., (2010). Putting market-facing technology to work: Organizational drivers of CRM performance. *Marketing Letters*, 21(4). 365-383
- Shareef, M. A., Kumar, V., & Kumar, U. (2008). Business-to-consumer (B2C) electronic commerce (EC) operation: Globalization strategy. *ASAC 2008, Halifax NS*. 164-180



- Şahbaz, U., Sökmen, A., & Aytaç, A. (2014). Türkiye’de E-İhracat Fırsatlar ve Sorunlar. *Türkiye Ekonomi Politikaları Araştırma Vakfı (TEPAV)*
- Tavakol, M. & Dennick, R. (2011). Making Sense of Cronbach’s Alfa. *International Journal of Medical Education*, 2. 53-55
- Türker, U. A. (1998). *Yöneticinin El Kitabı: İnsan Kaynakları Yönetimi*. İstanbul: Türkmen Yayınevi
- Verma, S. & Chaudhuri, R. (2009). Effect of CRM on Customer Satisfaction in Service Sector in India. *Journal of Marketing & Communication*, 5(2). 55-69
- Xu, Y., Yen, D., Lin, B. & Chou, D. (2002). Adopting Customer Relationship Management Technology. *Industrial Management & Data Systems*, 102(8). 442-452
- Zeng, Yun E., H. Joseph Wen, & David C. Yen (2003). Customer Relationship Management (CRM) in Business-to-Business (B2B) E-Commerce. *Information Management & Computer Security*, 11(1). 39-44
- Zallocco, R., Pullins, E. B. & Mallin, M. L. (2009). A Re-Examination of B2B Sales Performance. *Journal of Business & Industrial Marketing*, 24(8). 598-610



“

## Chapter 13

**READING INGMAR BERGMAN  
CINEMA FROM A CINEMATOGRAPHIC  
PERSPECTIVE THROUGH THE FILM  
SCENES FROM A MARRIAGE**

*Gözde SUNAL<sup>1</sup>*

”

---

<sup>1</sup> Dr. Öğr. Üyesi, İstanbul Ticaret Üniversitesi İletişim Fakültesi Görsel İletişim Tasarımı Bölümü, gsunal@ticaret.edu.tr, ORCID: 0000-0002-9535-5714

“Deep into the twilight room of the soul”

Ingmar Bergman

## Introduction

This study aims to read director Ingmar Bergman and his cinema, which has an important place in world cinema, from a cinematographic perspective. The study, which will be discussed on the axis of the film *Scenes from a Marriage*, presents a critical view of marital relationship, social relations and experiences. Bergman’s cinematographic way of telling this story sheds an important light on our day as well as his period.

Ernst Ingmar Bergman is a Swedish playwright and film director born in Uppsala in 1918. Bergman’s best-known films - besides the lesser-known *Scenes from a Marriage* - include *The Seventh Seal* (1957), *Wild Strawberries* (1957), *Through the Looking Glass* (1961), *Winter Light* (1963), *Silence* (1963), *Persona* (1966), *Screams and Whispers* (1972), *An Autumn Sonata* (1978) and *Fanny and Alexander* (1982). The films of the award-winning director have a constant main cast and an ossified crew. The female actors are Liv Ullman, Bibi Andersson, Ingrid Thulin, Harriot Andersson and Gunnel Lindblom; the male actors are usually Max Von Sydow and Erland Josephson, and the cinematographer is Sven Nykvist (Öztürk 2000: 177).

Bergman was raised in a very disciplined environment during his childhood. Bergman, who had an older brother and a younger sister with him, was constantly exposed to his father’s harsh attitude. This attitude, which he resisted throughout his life, caused traumas that haunted him. We can clearly see the reflections of these traumas in some of his films. For example, the 1982 film *Fanny and Alexandre* carries excerpts from his own life. Set in Uppsala, the city of his birth, the movie tells the story of a family. This film, which deals with Christianity, regret, ghosts, alienation and love, has received many awards. Best Director, Best Cinematography, Best Foreign Language Film, Best Costume, Best Costume and Best Art Direction.

Bergman’s upbringing with his father, who was a priest, caused him to learn all kinds of issues about life and death at an early age (Öktemer, 2020). Because he was acquainted with all basic human concepts at a young age, a search for truth and the questioning that comes with it can be observed in his life and even in his films. As he himself mentions in many interviews, it is known that he built an alter self to escape his father’s rage. The director, who was more dependent on his mother, stated in his

biography *The Magic Lantern* that he was more saddened by her death. When Bergman was young, he pretended to be sick to win his mother's attention (1990).

Character traits such as hiding the truth and lying at an early age became the reflections of the process of constructing a persona, an issue he would focus on throughout his cinematic life. With this ability to distort reality, which he acquired at an early age, he constructed a completely different reality in the following years and this influenced his narrative language in cinema. In his films, he is sometimes pessimistic and sometimes confronts himself as if he wants to find a solution to his own stuckness in his own life. It is thought to be surprising that Bergman, who was often restless, disharmonious and constantly angry, did not commit suicide throughout his life (Ay, 1994: 38).

When we look at the thematic structure of Bergman's films, we see that "he usually deals with universal themes such as male-female or female-male relationships, religious problems, his reckoning with God, revenge, loneliness, betrayal, alienation, and death in all their subtleties" (Öztürk 2000: 177). According to Bergman, "cinema is an art of portraiture. The connection between close-up and face is the most striking aspect of his cinema" (Bergman, 2012). From this point of view, the reason why the study focuses primarily on his cinematography is to emphasize what kind of narrative he wants to create with these techniques. Therefore, this framework aims to make a cinematographic reading of *Ingmar Bergman's Scenes from a Marriage*.

## **A Cinematographic Reading of Scenes from a Marriage**

“You and I spoiled each other so much,  
we were in an airtight existence.

Everything was perfect, not a single crack.

We died of asphyxiation.”

*Scenes from a Marriage* is a 1973 Swedish television series and film written and directed by Ingmar Bergman and starring Liv Ullmann and Erland Josephson. The story follows the gradual disintegration of the marriage between Marianne, a family lawyer specializing in divorce, and Johan over a period of 10 years. Bergman, who wrote the story based on her own experiences in her own relationships, including her relationship with Ullmann, originally shot the story on a small budget as a television series in Stockholm and Fårö. In 1972, this mini-series was broadcast on Swedish television as a 6-part series and later turned into a movie.

The film received positive reviews internationally and won an important award such as the Golden Globe Award for Best Foreign Language Film. Since the movie was first broadcast as a six-part series, the movie was divided into six parts. Therefore, the movie will be analyzed under the titles of these episodes.

## 1. Chapter: Innocence and Panic

“Last night someone was saying that  
the issuelessness itself is a big issue.”

The movie starts with an interview for a magazine. Marianne and Johan's two daughters are seen only in this scene throughout the movie. After the family photo, the girls leave the room and Johan and Marianne are left alone with the reporter's questions. In this interview, which starts with a wide shot, close-ups are used as special questions are asked. These shots draw attention to the frame and characters that the audience should focus on. The facial expressions and emotional states of the characters are read more clearly through these close-ups. In this scene, there is a tiny detail that is planted as a seed, which would go unnoticed if not watched carefully. After the photo for the magazine, Marianne gently pulls Johan's hand away from her and pushes it aside. This gesture, along with the cold and insincere smile on her face, can be read as the first physical reaction of Marianne's sexual withdrawal from having anything with Johan, which we will learn later during their conversation. Another noteworthy element is that when the reporter asks: "How would you describe yourself?" Johan can name a lot of things to describe himself, while Marianne cannot find anything else to say other than that she is married to Johan and they have two daughters.

In short, although Marianne is a lawyer, she says that she is Johan's wife instead. In fact, these dialogues show the audience that Marianne restricts herself in a position exactly according to the perception of the society she lives in, that is, she defines herself through her husband. In addition, Marianne, who answers the reporter's question of whether there have been no problems for 10 years by saying that there have been no financial difficulties, actually shows how society views marriage from a different perspective. In the society of that period, it was barely accepted for women to have a profession, but even if a woman had a good profession, she could be criticized even if she was married or not. When she marries, she belongs to a class or not based on the financial status of her husband. If there are no financial difficulties in the marriage, if the man is well-off and has a good job, the woman does not have much freedom in this marriage and even in the decisions she makes in her life and the way she

lives her life. We can clearly understand this from the dialogues between the characters in this scene.

Later in this scene, while Peter and Katarina are having dinner together, Johan reads the 'ideal couple' interviews from a magazine and there is a pleasant atmosphere. First, the camera descends from the stone chandelier above the table down to the dining table, positioning itself to see the ostentatious table and those around it. The ostentatious accessories shown in this wide shot are like a reflection of the characters. When they move from the table to the armchair, a more intimate atmosphere is created. As can be understood from this scene, Bergman has designed the space, decor, costumes, lighting, in short, the cinematography of the film to serve the emotions and narrative. Katarina and Peter continue to chat on the sofa and have a heated discussion. During this discussion, it becomes clear that the articles written by Peter were actually written by Katarina. It is thought to be a similar detail to Marianne's self-identification in the first scene through her marriage to Johan. In fact, while Peter is secretly existing himself through Katarina's writings, it is a symbol of Katarina's destruction of her own existence. As it can be understood from these scenes, both women exist mostly as wives and mothers.

After the couple leaves their home, Marianne tells Johan that the problem between them is the lack and inadequacy of communication. They are such an "ideal and exemplary" couple that they feel entitled to comment on other people's relationships. During this conversation Johan mentions that marriages should be for 5 years or renewed annually like a contract. When Marianne asks if this applies to them, Johan replies that they are an exception. During these conversations, the camera, as an outside observer, follows the movements of the actors in long shots. It is as if Bergman wants to look at the characters' marriage and this dialog in particular from the outside. The director also uses this positioning of the camera in the scene where Marianne and Johan argue before signing the divorce protocol.

## **2. Chapter: Sweeping Under the Carpet**

"Yes, I think I have the capacity for love, but... Everything is so closed in... This life is suppressing all my abilities. I have to do something now... Something very strange is happening... My senses - sight, hearing, feeling - are betraying me. I can tell that this table is a table. I see it, I touch it... but my relation to it is superficial and dry... You see? It's the same with other things... Music, smells, people's faces, everything is dull and fading, becoming worthless. Everything..."

In this section we first witness a conversation between Marianne and her client. The woman says that she wants to get divorced because there is no love in their marriage anymore (Actually she said that she wanted to leave 15 years ago but her husband told her to wait until the children grew up. The woman says that now that the children have grown up and left home, she can get a divorce). When her husband asked her what was wrong with the marriage, she said that it was impossible to sustain a marriage without love. When her husband asked her what love was, she said that she did not know what love was, “one cannot define something that does not exist”. Marianne wants to ask the woman something about love but gives up. The woman gives an example by saying “I touch the table but my relationship with it is superficial and dry”. Here, a very appropriate framing is done cinematographically. While she gives this example, we see Marianne’s puzzled face for a long time in close-up. In order to clearly show Marianne’s astonishment at what she heard and to keep the focus on Marianne, director Bergman chose to stay only on Marianne’s face for a long time instead of making a cut and showing her expressions. This camera and editing technique, which he uses to show Marianne’s emotions more clearly, is actually one of Bergman’s preferred methods in general. Bergman is one of the most important directors in search of face shots.

The shooting technique, also known as close-up, has been used effectively since the beginning of cinema. It would be appropriate to emphasize that another director who thinks like Bergman, Soviet film director and theorist Sergey Aizenştayn, said that close-ups give the film an affective reading. The best example of this is the tragic narration of the moment when a mother’s child is crushed in the *Odessa Sidewalks of Battleship Potemkin* (1925). From this perspective, we see that from the beginning of the movie, close-ups are preferred instead of general plans.

Later in the movie, Johan says: “People who have been together for a long time can lose their will a little”, Marianne says: “We haven’t lost it, we just have a lot of work and we are tired in the evenings”. In this scene Johan complains for the first time about not being able to make love, but Marianne says it’s not my fault. Marianne suggests to Johan, who complains that they don’t show affection to each other, that they should go on vacation this summer. Johan says I don’t think affection has anything to do with vacation. With this scene, we understand how different their perception of events and their solutions are. When Johan hugs Marianne and puts his hand on her breast, Marianne pushes Johan’s hand away. As in the first scene, a disturbed expression appears on Marianne’s face. The underlying reason for Marianne’s sexual reluctance is most likely the incorporation of her identity as a mother. She herself confirms this in



the movie when she says that this happened after having children. Johan realizes that the problem cannot be solved and says “it’s late, let’s go to bed”. Once they are in bed, Marianne says that we can make love if you want, to which Johan says thank you for the offer but I’m very tired. We can think that Marianne makes this offer because she knows that Johan is sure that she will refuse.

The general atmosphere of the movie reinforces the feeling of being stuck. The audience is constantly trapped in a gloomy environment by the lighting of the movie and the lack of outdoor scenes. While Bergman pays close attention to the use of light and shadow in his films, he avoids using color (Elsaesser 1995: 8), and we see this preference in this film as well. Especially the use of low light and pastel tones nourishes the atmosphere of the film.

### 3. Chapter: Paula

“Although I read a lot, existence  
I know very little about myself.  
I know nothing about myself  
but this disaster could be a chance  
for both of us to come back to life.”

In this episode Johan confesses to Marianne that he is in love with another woman and she cannot accept it. She begs Johan helplessly. When Johan first tells Marianne that he is in love with another woman, she says nothing, and when Johan gets angry and asks her to say something, Marianne says: “It’s strange that I didn’t suspect anything, everything was as usual, even better”. Johan: “Yes, you never noticed, you’ve never been a good observer”. As we can see, Marianne is too blinded in the marriage she has trapped herself in to realize how her marriage is going or not going. In such a conversation, Marianne becomes completely childish instead of a mature greeting and starts asking Johan one question after another in a way that irritates the viewer: “What are we going to do now, are we going to divorce, are you going to marry her, should we talk about it tonight”. Johan says that he cannot do without Paula and that he is going to Paris with her the next day. Later in the conversation, when talking to Marianne, Johan says that he wants to let everything go. In fact, he doesn’t know exactly what he wants either. This time it is Marianne who sweeps the problem under the rug. “Let’s go to bed, it’s late,” she says.

After finding out that he is in love with another woman, Marianne tells Johan that although she saw marks on his chest while he was undressing

and said something about him, she can go and pick up his dry-cleaned clothes and even pack his suitcase if he wants, as if nothing had happened.

But Johan doesn't want to. Marianne offers Johan an outfit in which he can look young and stylish. Marianne doesn't know what to do here, so she comes up with childish solutions, and the way she sits with her legs pulled close to her abdomen, as if in a fetal position, is a symbol of this. With the *mise-en-scène* set up in this frame, the audience is made to feel how helpless Marianne is.

In the morning of that night, Marianne continues to act as if nothing has happened, asking questions in her childlike innocence. It can be thought that what Bergman reflects with this scene is that a woman should serve her husband, that is, be obedient, no matter what the circumstances. The disturbing point of this scene is Marianne's innocence when she asks Johan whether he would like tea or coffee. The costume, angles and atmosphere that support this innocence are also a big factor in this point. Marianne is shown in this scene as a representation of the inability to break away from her "being married" status.

Another physical feature of Marianne that draws attention in this scene is that her hair has never been so disheveled before. Especially after this scene, we feel that the movie creates a voyeuristic, peeping feeling for the audience. It is as if the audience is involved in the process with the characters in the movie.

#### 4. Chapter: Valley of Tears

"We'll make love and you'll go away  
and I'll be sad again."

Johan arrives 6 months later and shows a warm and sincere attitude towards Marianne as if nothing had happened. There is a clear difference between Marianne's costume and hairstyle when she was abandoned and her costume and hairstyle now. With her hair and costume, an art direction is constructed to represent her disintegrating character and life. In these encounters, we are faced with a more feminine Marianne who has her life in order as well as her hair. In fact, it can be interpreted that this is to give the impression that she has overcome Johan and abandonment and is moving on with her life.

Even though Marianne tries to stand firm, Johan is still a weakness for her and we see her making an effort to resist this weakness. In this scene, it is discussed that they should now take care of the divorce proceedings. One of the important details is that Marianne tells Johan that she emptied his study and made "a room for her own". We see a Marianne who starts to

realize herself and her wishes. In this scene, we see that the table at which they have dinner is nothing like the flamboyant dining table we saw at the beginning.

## 5. Chapter: The Ignorant

“We are so emotionally ignorant, they taught us anatomy, agriculture in Pretoria, that the square of the hypotenuse is equal to the sum of the squares of the perpendicular sides, all kinds of shit, but not a single thing about the human soul. We are illiterate about ourselves and others.”

This episode takes place in Johan’s office. Marianne now seems determined to get a divorce. She arrives with the papers and the roles are reversed. Marianne is now completely liberated. Marianne, who had previously been asserting herself through her husband’s presence, now wants to separate from Johan. Despite all Johan’s attempts to make her feel sorry for herself, Marianne remains resolute and expresses her desire for a divorce in a nonchalant manner. This time Johan resorts to physical violence to stop Marianne. Johan throws a tantrum and locks the door to prevent Marianne from leaving. This is the first time Johan uses physical violence after the psychological violence he inflicted on Marianne. After hitting Marianne repeatedly, he gives her the keys. When Marianne comes back after cleaning her face, they both sign the papers without saying anything. Here the camera draws attention with its observer positions. Bergman witnesses the discussions like an outside eye during this whole process.

## 6. Chapter Midnight in a Dark House in a Corner of the World

“Sometimes I believe that  
I have never loved anyone.  
I think no one has ever loved me,  
it makes me very sad.”

This episode begins with a large-scale shot on the street that makes the viewer take a deep breath. Ingmar Bergman reflected the emotional turmoil and stuckness they were experiencing inside each other through a cinematographic narrative that was always trapped between four walls, except for the scene where they go to work together at the very beginning. Now Marianne and Johan have other lives and are married. But the couple, who are still seeing each other, come together when their spouses go on a business trip. We understand the change in both of their characters through their discourse. They can speak openly and honestly about life

and themselves, as if they had never been apart. We understand this very clearly from the following line; “It’s not our first but our twentieth year. We got married twenty years ago in August. A whole lifetime. We spent all our youth together, what a strange thing”.

In this last scene, we see that the color green is used quite intensely. The outdoor scene gives clues to the audience as a harbinger of the couple’s hope and happiness for the future. In this scene of the couple’s fling, we see long close-ups and even extreme close-ups. “A close-up is traditionally a shot that shows only the head, hands, feet and small objects. It emphasizes facial expression, the details of a gesture or an important object. Extreme close-up shows part of the face or magnifies an object” (Bordwell & Thompson, 2009:191). In the movie, these shots dominate especially in the scenes of their confessions to each other. They are used frequently and specifically to focus the audience on the characters’ speech and facial expressions.

## CONCLUSION

With *Scenes from a Marriage*, Ingman Bergman shows us not only the story of a marriage, but also how the society we live in influences our choices, our way of life and even who we are. The film, which harshly criticizes the fact that women have no identity other than their identities as married women and mothers, has a carefully constructed subtext.

The director reflects the fears of the characters in his films, the truths they do not want to face, in short, their unconscious. Throughout this process, the audience is completely focused on the subject with the narrative language and cinematographic expression he uses. In various scenes, he reveals the invisible realities behind the behaviors shown as ideal by society. The first thing to focus on in the movie is Marianne and Johan’s individual selves. Their emotions need to be well analyzed and understood in their personalities rather than their relationship. The complex emotions of people who don’t know what they want are left hanging.

While the color and lighting of the scenes at the beginning of the film are more gloomy, towards the end of the film we see that this dark atmosphere becomes brighter. Although we never see an exterior throughout the film, the camera goes outside at the end of the film and this relieves the audience to some extent. It is thought that the use of this narrative language is deliberate. The purpose of using the low key lighting technique, which dominates the entire movie, is to provide dramatic and sad emotions in the scenes. Throughout the movie, gloomy lighting is

dominant as a reflection of the character's inner world and even the decor and accessories reflect our characters.

When Marianne decides to get a divorce and take the risk to be herself, that's when we see a difference in the lighting of the movie. At the end of the movie, we see outdoor spaces that we have never seen in the movie with brighter and wider plans. In this process, the audience gets rid of the cramped, gloomy space and breathes a sigh of relief.

Each of Bergman's films has been evaluated in many ways, but it is seen that there has not been a detailed reading on the film *Scenes from a Marriage*. It has recently been staged in the theater, and Hagai Levi's television series of the same name in 2021 is also inspired by the film. In Hagai Levi's version, the story is told in reverse, but there are many striking commonalities.

Bergman often searches for the self in his cinematography. He often translates his own autobiographical story into films, and he goes into great detail both aesthetically and technically. Bergman is one of the important auteur directors in World Cinema with his own cinematic language, mise-en-scene and thematic structure. In this six-part film, Bergman tried to show how difficult it is for a woman to maintain her independent identity within the framework of marriage, where roles are clearly defined, social pressure prevails and we have illusions about it through education.

## REFERENCES

- Ay, T. (1994). Ingmar Bergman Sinemasında İntihar. 25. *Kare*, Sayı: 9, 71-100.
- Bergman, I. (1990). *Byl Fener*. G. Tařkın (ev), Afa Yayını, İstanbul.
- Bergman, I. (2012). *Sinematografi İnsan Yzdr*. S. zgl (ev.). İstanbul: Agora Kitaplıęı.
- Bergman, I. (Ynetmen/Senarist). (1974). *Scenes From A Marriage*, ABD: Criterion.
- Bordwell D. & Thompson K. (2009). *Film Sanatı*. E. Yılmaz ve E. S. Onat (ev.). Ankara: De Ki Yayınları.
- Elsaesser, T. (Temmuz- Eyll 1995) *Avrupa Sanat Sineması*, G. Sayın (ev). 25. *Kare*, Sayı: 12, 4-9.
- ktemer, C. (2020). *Benlięini Arayan Bir Sinematografin İmgeleri: Ingmar Bergman* www.gazeteduvar.com.tr
- Plone, A. (1975). Marital and Existential Pain: Dialectic in Bergman's Scenes From A Marriage. *Family Process*, 14 (3), 317-78.
- [https://tr.wikipedia.org/wiki/Bir\\_Evlilikten\\_Manzaralar](https://tr.wikipedia.org/wiki/Bir_Evlilikten_Manzaralar)

“

# Chapter 14

## **EXAMINING THE IRANIAN NUCLEAR PROGRAM THROUGH THE DOMESTIC POLITICS MODEL<sup>1</sup>**

*Erdal BAYAR<sup>2</sup>*

”

---

1 This study is produced from the master thesis named Iran's Motivations For Maintaining its Nuclear Program. See: Erdal Bayar, "Iran's Motivations for Maintaining its Nuclear Program", Graduate School of Social Sciences, Hacettepe University, 2015. Advisor: Assoc. Prof. Şebnem UDUM

2 Arş. Gör. Dr., Van Yüzüncü Yıl Üniversitesi, Erciş İşletme Fakültesi, Siyaset Bilimi ve Uluslararası İlişkiler Bölümü, Van, Türkiye, ORCID: 0000-0002-1726-7989, E-posta: erdalbayar@yyu.edu.tr.

## Introduction

Iran launched nuclear operations in 1957 as part of an agreement with the United States during the reign of Mohammad Reza Shah until 1979. Germany and France began the first nuclear power plants in Iran in 1974. These nuclear power plant building projects could not be finished following the Islamic Revolution. In 1980, Iraq attacked the Islamic Republic of Iran, sparking a war between the two nations. While the battle was still going on, Iranian officials decided to restart nuclear programs. Iran and Russia inked a pact in January 1995 to finish building the Bushehr reactors. As a result, Russia, which possesses sophisticated nuclear technology, has supplied significant assistance to Iran's nuclear operations. Iran's nuclear program has become an international issue in 2002, when it was uncovered that it neglected to notify some of its nuclear operations to the International Atomic Energy Agency. Concerned about Iran's nuclear program, the international community applied sanctions to discourage Iran's nuclear activity. Even though sanctions resolutions affected Iran, it maintained its nuclear activities.

Iran began negotiations with the EU/3 (United Kingdom, France, and Germany) nations in 2003, and the P5+1 (permanent members of the UN Security Council plus Germany) became a party to the process in 2006. The United States, on the other side, stressed the military intervention option. Although this difficult process has taken a positive turn, significant work toward a final settlement must be accomplished because the military option against Iran has not been eliminated. This prospect poses a huge threat to the Middle East's security.

States worried about Iran's nuclear program began imposing sanctions to deter Iran from pursuing nuclear weapons. Iran maintains its nuclear program despite economic losses because of the sanction's rulings. Dealing with Iran's nuclear program only for security purposes limits the scope of this problem. A multidimensional approach is required to overcome the problem. Therefore, this study will employ Scott Sagan's "three model approach", which give a holistic view on countries' aspirations to obtain nuclear weapons. The Security Model, the Domestic Politics Model, and the Norms Model are three of these approaches (Sagan, 1996: 55).

The "security model," which contends that governments acquire nuclear weapons for security reasons, will be beneficial in interpreting Iran's threat assessment. The "domestic politics model," which focuses on the primary domestic players who may have a say in the choice to build nuclear weapons, will be used to assess the influence of Iran's internal political system on its nuclear program. The symbolic significance of nuclear technology/weapons as interpreted by Iranians While doing so, the "norms model" will be a helpful tool.



Due to the study's limited scope, only one of these models will be examined. It would be more helpful to employ the domestic politics model, which is rarely referenced in the literature, especially given that security-based methods predominate in the subject.

### **The Domestic Policy Model**

The domestic policy model will be used to investigate Iran's nuclear program in this study, therefore it will focus on domestic policy figures who may directly or indirectly influence decision-making, because the fundamental analytical unit in the domestic policy model is the sub-state actors. According to Scott Sagan, three sorts of players play important roles in a state's choice to seek a nuclear bomb: the first category of actor covers the state's nuclear energy-related technical and scientific institutions. These organizations are known as technical universities, scientific institutes, and scientific organizations. One of these agencies for the Iranian nuclear program is the Atomic Energy Organization of Iran (AEOI). According to Sagan, the second sort of actor is the professional military as bureaucratic actors. The Islamic Revolutionary Guard Corps-IRGC is the most acceptable example to depict such entities in Iran. third, politicians (in Iran's case, the Supreme Leader, President, Supreme National Security Council, and Parliament) who may utilize nuclear concerns to boost their political standing and garner popular support (Sagan, 1996: 63-64). This model explains that security threats are not the only reason for nuclear proliferation and that potential threats to a state's security can be interpreted in various ways by domestic political actors. According to this approach, security issues are not the primary cause of armament decisions: they are rather windows of opportunity through which parochial interests might leap (Sagan, 1996: 64-65).

This proposition is valid for Iran's decision-making process. According to Abbas Maleki, foreign policy of the Islamic Republic of Iran is the consequence of complex, varied interactions between many governmental and non-governmental actors (Maleki, 2002: 51). Data and information that arrive through various routes (diplomatic, security, etc.) reach important decision-makers in foreign policy who have diverse perspectives, perceptions, and understandings of what may be in the national or organizational interests. However, this scenario is not an impediment to reaching a relative agreement on foreign policy, particularly when a threat to Iran appears. For example, George Bush's "Axis of Evil" speech, which accused Iran of being a threat to global security, offered an incentive for Iran's foreign policy decision-makers to work together despite their individual disagreements (Maleki, 2002: 52-53).

Similarly, the clash between many ideologies, objectives, and organizations shapes Iran's nuclear strategy. The AEIO, scientific organizations (such as technical universities and research institutions), and military-industrial organizations can be examined as a group under the Domestic Politics Model (Tagma and Uzun: 2012: 250).

### **Atomic Energy Organization of Iran**

Like other bureaucracies across the world, Iran's Atomic Energy Organization (IAEO), various universities and research organizations, and defense installations have their own priorities and interests. Iran's nuclear institutions and bureaucracy are apprehensive that an agreement with the IAEA will hinder them from achieving their survival goals (Maleki, 2002: 58).

The AEIO was formed in 1974 to oversee Iran's nuclear energy development. According to the AEIO's founding statute, the AEIO has control over all nuclear energy-related operations (Atomic Energy Organization of Iran, n. d.). Prior to the revolution, the Shah aimed to build a nuclear power plant with a capacity of 23,000 megawatts. To achieve this aim, advanced nuclear technology and infrastructure were required (Maragheh, 2002: 1). This institution commenced operations to meet these standards. Because to the Islamic Revolution and the Iraq-Iran conflict, the building of two nuclear power stations was halted. The new leadership was unconcerned with Iran's nuclear operations during the early years of the Islamic Revolution; hence, Iran's nuclear program was transferred to the Ministry of Energy (Kerr, n.d.). Iran relaunched its paused nuclear program in 1984, with the same long-term goal (20,000 MW) as when it was established (AEIO, n.d.). The AEIO regained its authority on nuclear activities and was promoted to a more prestigious position in the bureaucratic structure. Paul Kerr claimed that the AEIO is a strong bureaucratic player that has not only engaged in contentious nuclear operations but has also affected Tehran's diplomatic efforts to persuade the international community that its nuclear program is only for benign purposes (Kerr, n.d.).

Following the beginning of the nuclear conflict, the AEIO maintained its work. The Supreme National Security Council (SNSC-) established a committee to handle discussions with the Agency. This committee included the president of the AEIO. Former negotiating group leader Hassan Rouhani indicated that the committee had a part in the refusal of the halt of uranium enrichment activity. Paul Kerr quotes Hassan Ruhani's words from his interview with Mohammadi, "The nuclear fuel cycle was our red line and under no circumstances would we waive it." (Mohammadi, as cited in Kerr, n.d.).

The AEOI continues to play an essential role in the agency's negotiations. Furthermore, AEOI specialists can be regarded to be effective in moulding public perception concerning Iran's nuclear program. Experts in the subject of nuclear energy frequently give interviews to the Iranian press. According to Hadi Semati, popular support for the nuclear program has grown in recent years as public awareness of the program has grown (Semati, as cited in Kibaroglu, 2006: 94-95). Kayhan Barzegar, an Iranian academician at the Islamic Azad University, said that experts with nuclear energy expertise believe that there should be nuclear chances in Iran. Bureaucrats, scientists, and engineers directly involved with nuclear programs are concerned about the suspension of the uranium enrichment process and the cessation of nuclear projects since such an event would result in the loss of their employment and status (Barzegar, as cited in Kibaroglu, 2006: 94). Students at technical universities have comparable worries. Following the Paris deal, the temporary stoppage of uranium enrichment efforts sparked demonstrations by over 5,000 Sharif Technical School students (Tagma and Uzun, 2012: 250).

The number of scientific studies in the domains of physics, engineering, and notably chemistry has increased significantly in Iran (See Figure 1). (Archhambault, 2010: 6). According to scientific research statistics, Iran has seen a considerable increase in scientific studies in the following fields since 1990: inorganic and nuclear chemistry, particle physics, nuclear technology/engineering, and nuclear physics. Between 1990 and 2009, scientific production in these domains "...grew by just %34 at the global level, but Iran's scientific output surged 84 times." (Archhambault, 2010: 5). The Iranian government made investments and provided support for several scientific sectors. As a natural result of this predicament, scientists are frightened of losing their prospects.

Furthermore, the killing of Iranian nuclear experts gave symbolic importance to the AEOI's nuclear efforts. These scientists' sacrifice is offered as a symbol of resistance.

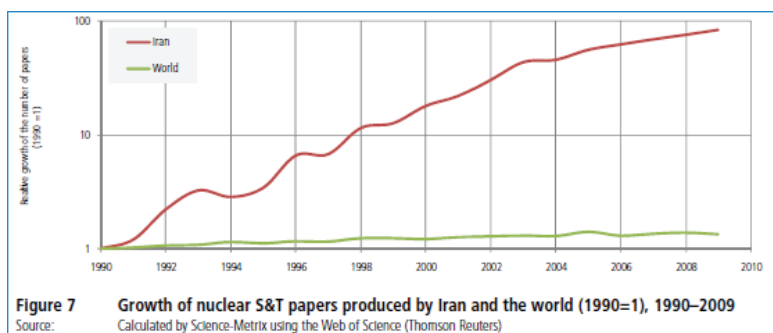

**Figure 1:** Growth of Nuclear related scientific papers produced by Iran  
 Source: Archhambault, E. (2010). *30 Years in Science: Secular Movements in Knowledge Creation*. Science- Metrix, p.6

Heads of the AEOI have voiced their desires for peaceful nuclear energy. They claim that there is no objective of uranium enrichment more than 20 percent. However, former head of the AEOI Fereydoon Abbasi stated that if Iranian scientists need nuclear reactors for building nuclear submarines and nuclear-powered ships, highly enriched uranium (from 45 percent to 56 percent) will be necessary (Reuters, 2013). Such words, which indicate the employment of nuclear technology in the military field, should not be overlooked. These assertions are raising concerns about Iran’s nuclear program, but no proof of nuclear technology being used for military purposes has been uncovered or could be found in this study.

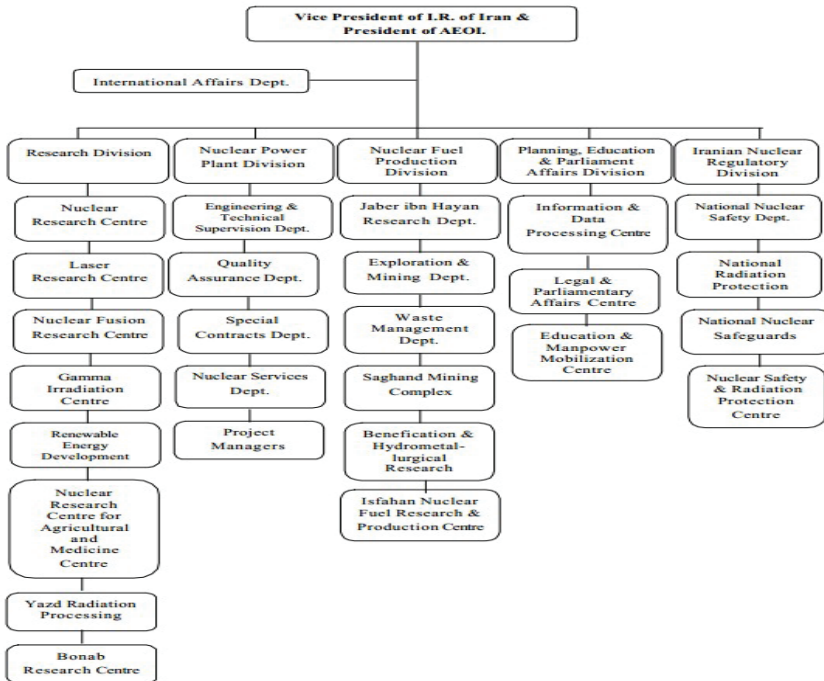

**Figure 2:** Structure of Atomic Energy Agency of Iran

**Source:** Maragheh M. G. (2002). Atomic Energy Organization of Iran. *World Nuclear Association Annual Symposium*, London.

### Islamic Revolution Guards Corps (IRGC)

The Islamic Revolution Guards Corps was formed in response to the need to construct a new army following the dismissal of several military officers following the Islamic Revolution. To maintain stability and order, Revolution leaders believed it was essential to develop a strong and formidable military force that was congruent with the new regime’s beliefs. Imam Khomeini issued instructions for the formation of the Army

of the Guardians of the Islamic Revolution (IRGC), which was formally established on April 22, 1979. The goals of this army were to safeguard the Islamic revolution and propagate the Islamic revolution's doctrine across the world. The IRGC also provides army members with intellectual, political, and military training. The IRGC also provides army members with intellectual, political, and military training. The official name of this army does not include the term "Iran," because the Army of the Guardians of the Islamic Revolution, according to those who carried out the revolution, is the army of the whole Ummah and is not restricted to Iran (Yegin, 2013: 64-65).

As soon as possible, the IRGC established itself throughout the country. It participated in the Iraq-Iran conflict with all its might after it began. Throughout the battle, new needs arose, and the IRGC expanded to meet these demands. The Islamic regime decided to form the IRGC's land, sea, and air forces on September 17, 1985. Following that, the IRGC was turned into a ministry, and Mohsen Rafiqdust was appointed as the Revolutionary Guards' first minister. This ministry was responsible with arranging to meet the war's demands. This ministry was decommissioned in 1989. The IRGC evolved into a more independent organisation under the direction of the Supreme Leader (رئیس‌جمهور) over time (See Figure: 5) Many significant political personalities (including Mahmoud Ahmadinejad, Saeed Jalili, and Ali Larijani) served in the army in various capacities. The Islamic Revolutionary Guard Corps (IRGC) is a significant military power. At the same time, it has played a key role in the country's rehabilitation following the Iraq-Iran war. Due to this role, it has achieved a significant position in the Iranian economy. Many significant enterprises in Iran are owned by the revolutionary guards, and the IRGC's economic operations are tax-free. (Yegin, 2013: 65-66).

The Revolutionary Guards did not get involved in politics until the mid-1990s, when Mohsen Rezai, Commander of the IRGC, expressed his support for Ali Akbar Nateq Nuri, a reformist candidate running against Mohammad Khatami. Mohammad Khatami won the presidential election, and following his inauguration, practically every significant job in Iran's military and security system changed hands (Eisenstadt, 1998: 72-73). The IRGC began to be more interested in politics from this date. Bayram Sinkaya shows the following as an example of this case: "*Interventionism of the IRGC was very apparent when the 24 senior IRGC commanders wrote a warning letter to President Khatami in July 1999 in the midst of student riots.*" (Sinkaya, 2011: 277). Following the 2005 elections, the IRGC's political power grew, and the Revolutionary Guards won key roles in the country's management. Because both recognized revolution protection as a priority, the IRGC established strong links to Mahmoud Ahmadinejad

and backed his presidential campaign. This common ground provided a chance to collaborate. Companies affiliated with the IRGC have expanded their economic opportunities (Sinkaya, 2011: 277). Ballistic missile tests, for example, have increased in frequency because of increased economic prospects and collaboration with the country's leadership, although this cooperation is not relevant in all instances. As evidence of this, when disagreements arose between Ali Khamenei and Mahmoud Ahmadinejad, the IRGC sided with the Supreme Leader because the IRGC was focused on defending the Islamic Revolution's ideals and the most significant symbol of the revolution, the Supreme Leader. In summary, the IRGC's principal purpose is to safeguard the revolution.

The IRGC plays an important role in Iran's economy and is the country's third largest enterprise. The IRGC has stakes and firms in practically every sector of the economy. Furthermore, the IRGC has various enterprises functioning under Iran's nuclear and ballistic missile projects. It is also a major player in Iran's building sector (Khatam al Anbiya-the Seal of the Prophet- which is the IRGC's construction headquarters and one of the most prominent governmental economic activity centers) (Nader, 2010). In sum, the IRGC is at the heart of Iran's ballistic missile and nuclear programs. As a result, the IRGC is one of the primary Iranian institutions targeted by sanction resolutions (Taheri, 2013). UN Security Council Resolution 1929 (approved on June 9, 2010) decided to penalize several IRGC-owned enterprises (Önder, 2013: 339-340). According to Amir Taheri, the Iranian Nuclear Energy Organization (Sazman Enerji Atomi Iran), the head of which is selected by the president of the Islamic Republic, controls the nuclear program, which is ostensibly aimed for benign uses such as the generation of electricity. In practice, the IRGC supervises the program from strategic conception through production and management under the authority of the Supreme Leader.

According to IRGC officials, the concept of continuing the nuclear program. For example, IRGC Deputy Commander Brigadier General Salami underlines unequivocally that Iran's nuclear program cannot be stopped. Brigadier General Gholam Reza Mehrabi stressed that Tehran should not make any concessions on the nuclear issue and should never back down. In summary, the IRGC is key to Iran's nuclear development, and it is willing to sustain the program. It should be mentioned, however, that the IRGC and the Supreme Leader, who is the commander-in-chief of the whole armed forces, agree on the nuclear problem.



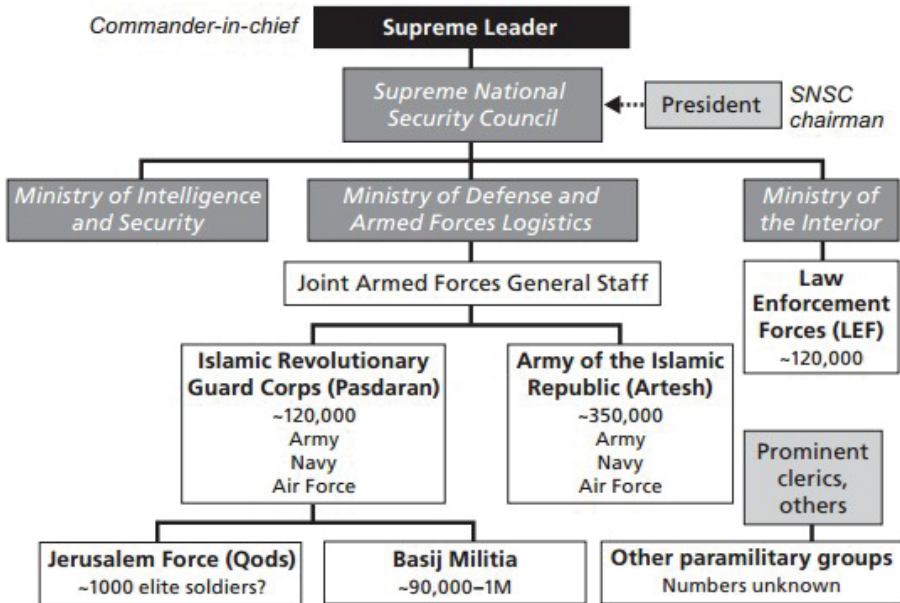

**Figure 3:** Iran's National Security Establishment

**Source:** Frederic Wehrey, Jerrold D. Green, et. al. "The Rise of the Pasdaran: Assessing the Domestic Roles of Iran's Islamic Revolutionary Guard Corps", RAND Corporation, 2009, p.9

## The President

The President is the chief executive and oversees state administration. The position of Premier was abolished by a constitutional change in 1989. Article 114 of the Iranian Constitution states that "*the President is chosen for a four-year term by direct popular vote. His re-election for a second term is only permitted once.*" According to Article 122, the President is answerable to the people, the Supreme Leader, and the Islamic Consultative Assembly, as well as the laws and the constitution (Parliament). Ministers are appointed with the agreement of the Assembly, which is also responsible for defining the membership of the Council of Ministers. As a result, presidents cannot convene a council of ministers whenever they wish. For Hassan Rouhani, for example, the process of forming the new government was not easy. Three of Rouhani's nominees were rejected by the Iranian Parliament (Dehghan, 2013). New candidates were suggested for the three vacated seats, but Parliament did not easily approve them. Proposing a candidate for the Ministry of Science, Research, and Technology was especially popular among the conservative lawmakers who hold the majority in both the Presidency and the Parliament. The

Assembly voted against Rouhani’s two choices for science minister in October and November 2014. As a result, Rouhani’s fourth nominee for science minister was also rejected (Mehr News, 2014).

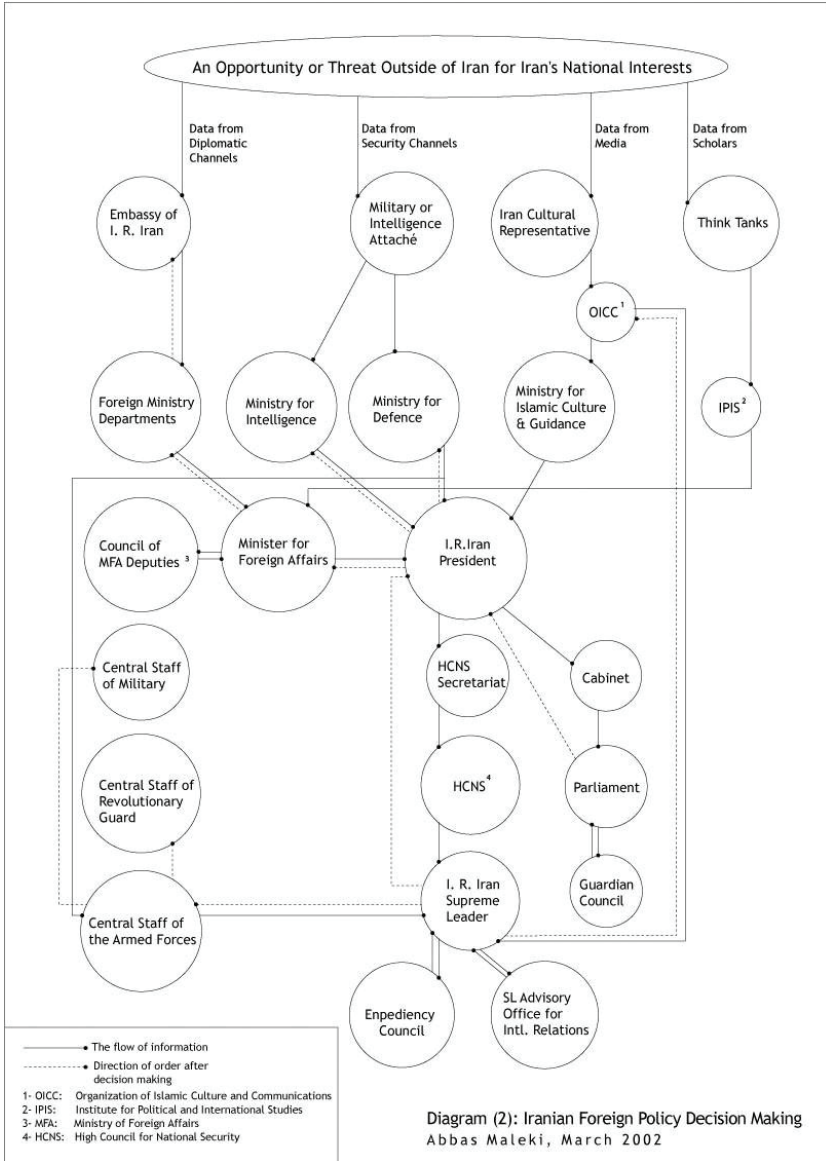

**Figure 4:** Foreign Policy Decision Making Process in Iran

**Source:** Maleki, A. (2002). *Decision Making in Iran’s Foreign Policy: A Heuristic Approach*. *Journal of Social Affairs*, 19(73).

Presidents’ political opinions are influential in determining foreign policy. Presidents have an important role in the formulation of foreign policy choices (See: Figure: 14). Data from several sources converge at



the presidency, and the President examines the information presented to him. After then, the material is forwarded to the High Council on National Security. According to Abbas Maleki, Iran's foreign policy decision-making process is as follows: After the Council decides on a course of action, then the Iranian President, who is also the head of the HCNS, would send the report to the Iranian Supreme Leader. If the Leader confirms the action, then it would be operationalized and sent to military sections, and to the Foreign Ministry (Maleki, 2002).

As can be seen, the President participates in several phases of the foreign policy decision system. Although foreign policy choices must be authorized by the Supreme Leader, the President is accountable for carrying them out. As a result, presidents' political opinions have an impact on policy implementation. For example, after the rise of the nuclear crisis, Mohammad Khatami's efforts to maintain good ties with the West have resulted in the popularity of the diplomatic strategy. As a gesture of good faith, Iran signed the Additional Protocol and suspended its uranium enrichment efforts. During Mahmoud Ahmadinejad's administration, the nuclear debate got increasingly serious, and the UN Security Council imposed multiple sanctions on Iran. The severity of the conflict decreased with the inauguration of new President Hassan Rouhani, and diplomatic attempts gained priority.

The office of President is a political one. As a result, presidents cannot be apathetic to nuclear matters, which are of great importance to a huge portion of the people. Nuclear problems dominated Mahmoud Ahmadinejad's political rhetoric, particularly during his administration. During this time, April 9th was designated as Iran's National Day of Nuclear Energy. The regime's acquisition of uranium enrichment technology was considered as a tremendous accomplishment. According to Hossein Seifzadeh, the Islamic Republic attempts to exaggerate its achievements in peaceful nuclear technology as a means of bolstering its legitimacy. This "great achievement of the Islamic Republic" indicates the Islamic Republic's potential for human resource development when contrasted to Dr. Mossadeq's success in nationalizing petroleum natural resources in 1951, despite its collapse in 1953 by a US-British-led coup (Seifzadeh, 2005: 137).

The Iranian government appears to be opposed to nuclear disarmament. "Resisting the foreign oppressor is so important to Iranian nationalist mythology," writes Ali M. Ansari. Ansari (2009), p. 45. As a result, conservative politicians frequently employ resistance notions. Similarly, freshly elected President Hassan Rouhani employed the same rhetoric (Iranian Presidential Website, 2014). The nuclear controversy is an appropriate setting for this political debate. Sanctions improve the

social stability of this group. Iran is emerging from an economic slump. To avoid the detrimental effects of sanctions, the Supreme Leader has recommended moving to a “resistance economy.” As a result, the Iranian economy would prefer to utilise internal resources more efficiently, earning the distinction of a sophisticated knowledge-based economy. It is true that the term “economy of resistance” arose as an Iranian response to the Western sanctions system, and it is also true that some of the above goals are intended to bolster the Iranian economy in the face of foreign pressure. The majority of the aforementioned objectives, however, were previously outlined in the country’s 20-Year Prospective Document (also known as Vision 2025), which was passed and officially mandated by Khamenei in 2005. The Iranian government was urged by Vision 2025 to prepare the way for Iran to become a knowledge-based economy and the region’s top economic and technical power by 2025 (Khajehpour, 2014).

Iranian political elites expect the lifting of sanctions imposed on Iran. According to Iranian President Hassan Rouhani, the West has no choice but to withdraw the “cruel” sanctions imposed on the Islamic Republic. In recent years, the impact of sanctions on Iran has grown increasingly lethal. The extension of sanctions and their application by other nations contributed significantly to the formation of this predicament (Uzun, 2013: 66-67). Although sanctions were imposed due to Iran’s nuclear program, the government’s economic policies were criticized. In short, the detrimental impact of sanctions has not yet placed the nuclear program in jeopardy (Uzun, 2013: 69). According to Barbara Slavin, during the campaign, Rouhani drew a link between Iran’s poor economic performance and Iran’s failure to reach an agreement with the international community on its nuclear program, noting that while more centrifuges were nice, wheels in Iranian factories also needed to spin (Slavin, 2013).

### **The Supreme Council of National Security and the Islamic Consultative Assembly**

The Supreme Council of National Security (also known as the High Council on National Security) is an institution whose duties and authorities are defined in the constitution Article 176.

*“A Supreme Council of National Security presided over by the President will be established to secure national interests, preservation of the Islamic Revolution, national sovereignty, and territorial integrity of the Islamic Republic. It is to fulfill the following duties: 1. Determine the defense and national security policies within the framework of the general policies determined by the Leader. 2. Coordinate political, intelligence, social, cultural, and economic activities in accordance with the general defense and security plans. 3. Utilize the material and non-material resources of*

*the country to confront internal and external threats.*" (Constitution of Islamic Republic of Iran).

The Council shall be composed of the following members: the heads of the three branches of government, the chief of the Supreme Command Council of the Armed Forces, the officer in charge of planning and budget affairs, two representatives nominated by the Leader, ministers of foreign affairs, interior, and information, a minister related to the subject, and the highest-ranking officials from the Armed Forces and the Islamic Revolution's Guards Corps (Constitution of Islamic Republic of Iran, Article 176).

In accordance with its responsibilities, the Supreme Council for National Security will establish sub-councils such as the Defence Sub-council and the National Security Sub-council. Each Sub Council shall be headed either by the President or a member of the Supreme Council for National Security designated by the President. The Supreme Council of National Security will approve the organizational structure and authority of the sub-councils. The Supreme Council of National Security's decisions will take effect when they have been approved by the Leader (Constitution of Islamic Republic of Iran, Article 176).

This council determines foreign policy choices and seeks the Supreme Leader's approval. Although civil and military bureaucracies have a balanced role in the creation of foreign policy choices, this equilibrium can be broken during periods of greater military political weight.

On May 28, 1980, Imam Khomeini resurrected the Islamic Consultative Assembly of Iran, often known as the Islamic Parliament of Iran. Prior to the Islamic Revolution, the parliament was known as the "National Consultative Assembly." The Islamic Parliament of Iran has 290 members who are chosen for a four-year term. As previously stated, minorities in Iran have the right to be represented in the Islamic Parliament. Minorities have quotas in the Islamic Parliament, according to Constitution Article 64: Zoroastrians have one, Jews have one, Ashura and Chaldeans have one, South Armenians have one, and Northern Armenians have one.

Because the Islamic Parliament of Iran is the only entity empowered to pass laws, it plays an essential role in Iran's political framework. The parliament can also approve the council of ministers. To be appointed, ministers must get a vote of confidence from parliament. The legislative machinery can function smoothly if there is agreement between the Parliament and the President, who oversees creating the administration. However, such unity between these two institutions is not always guaranteed. As previously stated, President Hassan Rouhani's fourth nomination for Minister of Science, Research, and Technology did not receive a vote of

confidence. Similar scenarios have occurred in the past, and the President's plans have been thwarted by Iran's Islamic Parliament. As a result, the ideological attitude of parliamentarians is critical for the maintenance of programs. There was some disagreement between the president and parliament about Iran's nuclear program. Mohammad Khatami signed the Additional Protocol with the aim of profiting from conversations with the EU/3, and Iran's enrichment operations were gladly suspended for a while. However, the US invasion of Iraq and anti-Iran rhetoric have put reformists in a precarious position. Hardliners who obtained a majority in Iran's Islamic Parliament in 2004 criticized reformists for being too timid and weak in protecting Iran's interests (Chubin, 2010). Following the inauguration of new President Mahmoud Ahmadinejad in 2005, there was cooperation between the Parliament and the Presidency. Iran's nuclear efforts accelerated, and the country's first nuclear reactor, at Bushehr, commenced operations in 2010.

In brief, the Islamic Parliament of Iran has the authority to expedite or slow policy execution. As a result, the significance of the Parliament should not be underestimated. However, keep in mind that all laws enacted by the parliament must be presented to the Guardian Council of the Constitution for approval (Yegin, 2013: 56-57).

### **The Supreme Leader**

The Supreme Leader (Ayatollah Imam Khomeini) was elevated to the pinnacle of the Islamic Republic following the Islamic Revolution. With his charismatic leadership, Imam Khomeini, the founder of IRAN, acquired all political authority. Under normal circumstances, Revolution leaders wanted to construct a system of checks and balances between two focal centers of political authority, but the balance appears to be skewed in favor of the Supreme Leader, Iran's most powerful political figure. Following the death of Imam Khomeini in 1989, the Assembly of Experts nominated Sayyid Ali Hamanei as the new head of the revolution. The appointment of the next Supreme Leader, Sayyid Ali Khamanei, started the transition process. The new Supreme Leader lacked the charm of his predecessor, Ayatollah Ruhullah Khomeini, and lacked the religious authority required to be Marja-i Taqlid. As a result, Ali Khamanei's empowerment occurred at the end of a process (Milani, 1992: 175)

According to Article 57, the Supreme Leader has authority over the legislative, executive, and judicial branches of government, and these branches report to him. Iran's constitution grants the leader extensive autonomy (Constitution of Islamic Republic of Iran, Article 110). Sayyid Ali Hamanei wields these powers through his deputies (See Figure: 5).

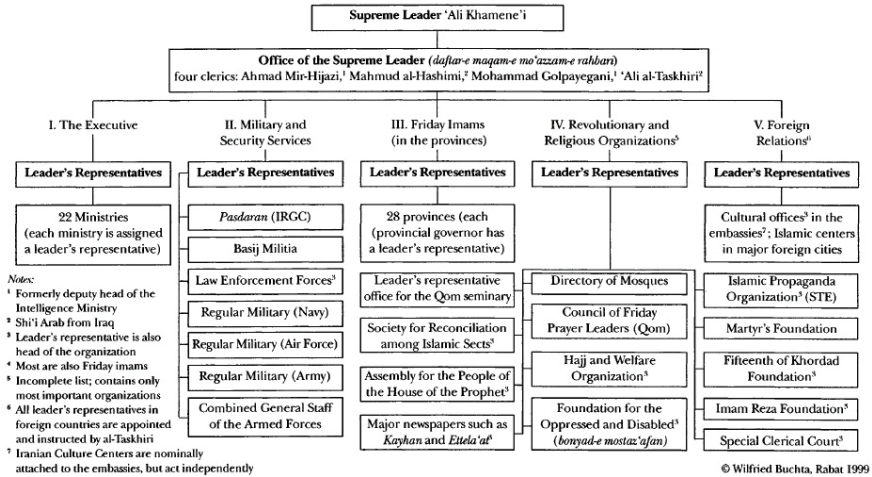
**Figure 5: Authorities of the Leader of the Revolution**

**Source:** Buchta W. (2000). *Who Rules Iran: The Structure of Power in the Islamic Republic. The Washington Institute for Near East Policy and Konrad Adenauer Stiftung, Washington, p.49*

In October 2003, Ali Hamanei issued a fatwa forbidding the production and use of WMD. According to him, Islam proscribes nuclear weapons and other WMD. Use of these types of weapons is *haram* (prohibited under the Islamic Law) and illegal (Eisenstadt and Khalaji, 2011: 14). Many fatwas issued by Khamenei suggest that nuclear weapons are *haram* and nuclear energy is a right (See: khamenei.ir). Iranian officials routinely cite to these fatwas as proof of Iran's benign nuclear programs. We must not overlook the fact that the fatwa is not immutable. As a result, the Supreme Leader and the Iranian administration may shift their positions.

The Supreme Leader determines the main policy of the Islamic Republic. Although he is not the primary policymaker, he is extremely effective in defining the fundamental framework. The ongoing nuclear talks are being conducted with his knowledge and cooperation. Despite changes in nuclear conversations prompted by differences in the Presidents' political personalities, Iran's nuclear plan remains unbroken. Iran is steadfast in its pursuit of nuclear fuel cycle technology. This is not debatable.

Despite his support for the negotiation process, the Supreme Leader is not hesitant to criticize it and other government concerns. The Supreme Leader is adamant on continuing the development of Iran's nuclear program (Hosseini, 2009). As a result, Ali Khamenei repeatedly mentions the decision to temporarily halt nuclear activity. According to Secretary of Iran's Supreme National Security Council Ali Shamkhani, diplomatic ties between Iran and the United States are limited only to the nuclear talks (Askarieh, 2014).

## Assessment

The Domestic Politics Model focuses on domestic players who have influence over decision-making. According to Sagan, three types of players play critical roles in a state's choice to seek nuclear weapons: the state's nuclear energy infrastructure, the professional military as bureaucratic actors, and politicians. The AEIOI, the IRGC, the President, the Supreme Leader, the Supreme National Security Council, and the Parliament were picked in the case of Iran. Individuals and organizations involved in nuclear technology support the continuance of the nuclear program. With Iran's investment in its nuclear program, the Atomic Energy Organization of Iran (AEIOI), technical universities, and nuclear researchers received enormous facilities and reputation. These institutions and people favor the continuation and expansion of the nuclear program and wish to steer the negotiating process in this direction. Nuclear experts and students at technical institutions are also staunch advocates of Iran's nuclear program, arguing that nuclear technology represents a high degree of research and demonstrates Iran's scientific advancement.

Because the president is the only person who can utilize the nuclear program as a foreign policy instrument, the president's approach to it is critical in shaping general policy. The President, as the head of execution, oversees carrying out national policies. As a result, the President can be considered to have an impact on how the nuclear program is implemented. The resurrection of military institutions is also a presidential requirement. As a result, the president is crucial in establishing the form of the cabinet and the High National Security Council.

Because it has several enterprises functioning under Iran's nuclear and ballistic missile programs, the IRGC makes an essential contribution to the program's sustainability. It is hardly unexpected that the IRGC has been the focus of sanctions. The IRGC chooses its position in line with the Supreme Leader's (also commander-in-chief) commands since the safeguarding of revolutionary ideals is the IRGC's top priority.

The Supreme Leader, Ali Khamanei, who sits atop the state's political system, is the most influential political person backing Iran's nuclear programs. Sayyid Ali Khamanei has the ability to establish the country's general policy. Being the approval authority also provides a useful instrument in policy management. Because it symbolizes the ultimate religious authority, the Supreme Leader has sway over the populace. According to Velayet-e Faqih doctrine, his fatwas are viewed as religious order.

The Islamic Parliament of Iran has the authority to expedite or slow policy execution. The difficulties that Hassan Rouhani had in forming



his government are the most dramatic example of this assertion. The Parliament has the jurisdiction to ratify treaties and approve government appointments. As a result, the significance of the Parliament should not be underestimated. However, keep in mind that all laws enacted by the parliament must be presented to the Guardian Council of the Constitution for approval.

The Supreme National Security Council is the body in charge of determining governmental policy. All facilities implement policies that have been approved by the Supreme Leader. Iran's nuclear program is carried out in collaboration among institutions; hence it is feasible to refer to the nuclear program as a national effort. The fatwa issued by Supreme Leader Ali Khamanei adds a religious dimension to this initiative. Nuclear weapons were ruled haram by this fatwa. The Velayat-e Faqih idea holds that the Imam's (God's representative on Earth) ijtihad must be obeyed. This fatwa may be regarded as the most significant step in favour of the nuclear taboo strategy. Iranian officials frequently state that they seek to create peaceful nuclear energy. A declaration confirming the existence of nuclear weapons should not be expected from Iranian leaders as they strive for a distinguished standing in the international arena.

To summarize, the Iranian nuclear program and its reasons cannot be fully understood from either security or energy perspectives, hence the internal political structure of Iran should be considered since it plays a big role in the execution of Iran's nuclear program. Nuclear technology's symbolic connotations should not be overlooked, since they provide a fertile field for driving elements. In the case of Iran, the symbolic significance assigned to the nuclear program make it impractical to completely abandon Iran's nuclear operations. As a result, the negotiating process should be carried out while keeping this criterion in mind.

## BIBLIOGRAPHY

- Sagan, S. D. (1996). Why Do States Build Nuclear Weapons?: Three Models in Search of a Bomb. *International Security*, 21(3), 54–86. <https://doi.org/10.2307/2539273>
- Maleki, A. (2002). Decision Making in Iran's Foreign Policy: A Heuristic Approach. *Journal of Social Affairs*, 19(73), 39-59. <https://citeseerx.ist.psu.edu/viewdoc/download?doi=10.1.1.335.8137&rep=rep1&type=pdf>, [Access Date:13.09.2014]
- Tagma, H. M., Uzun, E. (2012). Bureaucrats, Ayatollahs, and Persian Politics: Explaining the Shift in Iranian Nuclear Policy, *Korean Journal of Defense Analysis*, 24(2), 239-264.
- Atomic Energy Organization of Iran (n. d.). *A brief introduction to the Atomic Energy Organization of Iran*, Retrieved from <https://aeoi.org.ir/en/portal/home/?47317/%d8%b5%d9%81%d8%ad%d9%87-about-us>
- Maragheh M. G. (2002). Atomic Energy Organization of Iran. *World Nuclear Association Annual Symposium*, London. Retrieved from <https://www.iranwatch.org/sites/default/files/iran-aeoi-worldnuclearassociation-090402.pdf>
- Kerr, P. Arms Control Association. (n. d.) *The Atomic Energy Organization of Iran: What Role?* Retrieved from <https://www.armscontrol.org/act/2014-10/features/atomic-energy-organization-iran-what-role>
- Archhambault, E. (2010). 30 Years in Science: Secular Movements in Knowledge Creation. Science- Metrix, Retrieved from <http://rosmu.ru/activity/attach/opinions/111/30years-paper.pdf>
- Kibaroglu, M. (2006). Good for the Shah, Banned for the Mullahs: The West and Iran's Quest for Nuclear Power. *Middle East Journal*, 60(2), 207–232. <http://www.jstor.org/stable/4330247>
- Iran may need highly enriched uranium in future, official says (2013, April 16). *Reuters*. Retrieved from <https://www.reuters.com/article/us-iran-nuclear-idUSBRE93F12C20130416>
- Yegin, A. (2013). *Iran Siyasetini Anlama Kılavuzu*. Ankara: SETA Yayınları.
- Eisenstadt, M. (1998). The Military Dimension. In Patrick Clawson et. al. (ed.) *Iran Under Khatami: A Political, economic and Military Assessment*, Washington: The Washington Institute for Near East Policy.
- Sinkaya, B. (2011). *The Revolutionary Guards and The Iranian Politics: Causes and Outcomes of the Shifting Relations Between the Revolutionary Guards and the Political Leadership in Post-Revolutionary Iran*, (Unpublished Ph.D. Thesis), Middle East Technical University, Türkiye.
- Nader, A. (2010). The Revolutionary Guards. *The Iran Primer*, Retrieved from <http://iranprimer.usip.org/resource/revolutionary-guards>.



- A. Taheri. (2013, January 4). Guardians of the Revolution: Myths and Reality. *The Majalla*, <http://www.majalla.com/eng/2013/01/article55237014>.
- Önder, E. (2013). *Iran'ın Nükleer Programının Analizi Ve Türkiye: İlişkiler, Yaklaşımlar Ve Gelişmeler*. İstanbul: IQ Kültür Sanat Yayıncılık.
- Dehghan, S. K. (2013, August 15). Iran's Parliament Approves 15 of Hassan Rouhani's 18 Cabinet Ministers. *The Guardian*. Retrieved from <https://www.theguardian.com/world/2013/aug/15/iran-middleeast>
- Majlis Rejects Rouhani's 4th Science Ministry Candidate (2014, November 18). *Mehr News Agency*. Retrieved from <https://en.mehrnews.com/news/104691/Majlis-rejects-Rouhani-s-4th-Science-Ministry-candidate>
- Seifzadeh, H. (2005). Iran's Assertiveness In Maintaining Its Peaceful Nuclear Technology: Foreign Effectiveness And Domestic Efficiency. *Perceptions: Journal of International Affairs*, 10 (3), 127-151. Retrieved from <https://dergipark.org.tr/en/pub/perception/issue/49003/625154>
- Ansari, A. M. (2009). *Iran under Ahmadinejad: the politics of confrontation*. New York: Routledge.
- Iranian Presidential Website. (2014, November 26). *President in visiting family of martyred nuclear scientist: Martyred nuclear scientists are symbol of resistance*. Retrieved from <https://president.ir/en/82672>
- Khajehpour, B. (2014, February 24). Decoding Iran's 'resistance economy. *Al Monitor*. Retrieved from <http://www.al-monitor.com/pulse/originals/2014/02/decoding-resistance-economy-iran.html>
- Uzun, Ö.S. (2013). İran'a ekonomik yaptırımlar: Kırılğanlaşan Nükleer Program mı Hükümet mi?. *Ortadoğu Analiz*. 5(54) 62-70.
- Slavin, B. (2013, July 15). Rouhani Decides Honesty Best Policy on Iran's Economic Mess. *Al Monitor*. Retrieved from <https://www.al-monitor.com/originals/2013/07/rouhani-iran-economic-policy-honest.html>
- Chubin, S. (2010, October 6). The Politics of Iran's Nuclear Program. *United States Institute of Peace*, The Iran Primer. Retrieved from <https://iranprimer.usip.org/resource/politics-irans-nuclear-program>
- Milani, M. M. (1992). The Transformation of The Velayat-E Faqih Institution: From Khomeini to Khamenei. *The Muslim World*, 82(3-4), 175-190. <https://doi.org/10.1111/j.1478-1913.1992.tb03551.x>
- Eisenstadt, M., & Khalaji, M. (2011). *Nuclear Fatwa: Religion and Politics in Iran's Proliferation Strategy*, Washington: The Washington Institute for Near East Policy.
- <https://www.washingtoninstitute.org/media/3344?disposition=inline>
- Supreme Leader Sayyid Ali Khamenei's Website. Nuclear weapon is Haraam; Nuclear energy is a right. (2012, August 30). Retrieved from <https://english.khamenei.ir/> <https://english.khamenei.ir/news/2270/Nuclear-weapon-is-Haraam-Nuclear-energy-is-a-right>

- Hosseinian, Z. (2009, March 20). Iran leader says world can't stop nuclear progress. *Reuters*. Retrieved from. <https://www.reuters.com/article/us-iran-usa-obama-khamenei-sb-idUKTRE52J31420090320>
- Bastani, H. (2014). *How Powerful is Hassan Rouhani in the Islamic Republic?*. The Royal Institute of International Affairs, London: Chatham House Publications.
- Askarieh, E. (2014, December 24). Resumption of ties with US not on Iran agenda: Shamkhani. *Iran Front Page News*. Retrieved from <https://ifpnews.com/resumption-ties-us-not-iran-agenda-shamkhani/>
- Buchta W. (2000). *Who Rules Iran: The Structure of Power in the Islamic Republic*. Washington: The Washington Institute for Near East Policy and Konrad Adenauer Stiftung.
- Wehrey, F., Green, J. D., Nichiporuk, B., Nader, A., Hansell, L., Nafisi, R., & Bohandy, S. R. (2009). *The Rise of the Pasdaran: Assessing the Domestic Roles of Iran's Islamic Revolutionary Guards Corps*. RAND Corporation. <http://www.jstor.org/stable/10.7249/mg821osd>

“

## Chapter 15

**A RESEARCH ON CONSUMERS’  
ATTITUDES TOWARDS HALAL  
CERTIFIED PRODUCTS<sup>1</sup>**

*İbrahim ALKARA<sup>2</sup>*

”

---

1 Turkish abstract paper was presented at the Aegean 4th International Congress of Social Sciences (February 2022) with the data used in this study.  
2 Dr. Öğr. Üyesi, Bilecik Şeyh Edebali Üniversitesi, Bozüyük MYO, Endüstriyel Sürdürülebilirlik Yüksek Lis. Programı, E-mail: İbrahim.alkara@bilecik.edu.tr ORCID:0000-0001-8575-2524

## 1. Introduction

The concept of halal, which has especially been emphasized by Muslim communities in recent years, means “one that is not contrary to the rules of religion and not prohibited in terms of religion” by the Turkish Language Institution (TDK, 2005, p. 874, cited in Çallı, 2014: 44). The concept of halal has taken its source from the Qur’an and refers to products and behaviors that are not harmed when used in accordance with the Sunnah of our Prophet and the verses in the Qur’an. There are many verses in our holy book that contain the commandments about the consumption of halal products. One of these verses: Bakara 168: “O you who believe! Eat of the clean and halal sustenance we have given you! If you serve only Allah, give thanks to Him!” can be given as an example (Demirağ, 2020: 3407). Halal certificate is issued with the conviction that halal products are prepared in accordance with Islam and is an international document given to products that are not prohibited by Islam. Delegations of Islamic law experts and technical experts take part in the preparation process of this document. For organizations to issue certificates for food products, organizations should be independent in this process, independent academics who have a good command of technical issues such as production and additives, and scientists with fiqh science should take part in the committee. The names of some institutions authorized to issue halal certificates in our country and in the world are as follows (Çöp Vd., 2021: 48-53): Food and Necessary Substances Inspection and Certification Research Association (GIMDES), World Halal Association, Halal Association (HELALDER), Halal Food Inspection and Certification Center (HEDEM), Turkish Standards Institute (TSE), Halal Accreditation Agency (HAK), Malaysia Islamic Development Office (JAKIM), Islamic Countries Standards and Metrology Institute (SMIIC), Islamic Society of North America (ISNA).

The world population has approached 8 billion today. It is known that approximately 25% of this is made up of Muslims, and according to estimates, Muslims spent approximately \$2.02 Trillion on food, medicine, cosmetics, fashion, travel, media and entertainment sectors in 2019. Spending on food alone is \$1.17 Trillion. However, it is estimated that the world halal food market will reach 3 Trillion Dollars by 2023. It is thought that the expenditures on all these halal products are influenced by the Islamic faith. Many governments around the world, especially Malaysia, are striving to establish Islamic-based economic ecosystems. According to the Global Islamic Economic Indicators (GIEI), Malaysia has been in the top rank for the last 8 years, followed by countries such as Saudi Arabia, the United Arab Emirates and Indonesia in the second place. Various strategic partnerships are being established to expand halal trade in Indonesia and the Philippines, as well as in Japan and Malaysia. Pakistan, Qatar and

Kuwait announced that they are working on new central regulations in the Islamic Finance Sector. Another development regarding the halal product sector is that companies in Germany are reported to invest more in the halal food, pharmaceutical and cosmetics sectors in 2020 compared to the previous year (Öztürk, 2022: 128).

Planned Behavior Theory (PBT) is a behavior theory developed by Fishbein and Ajzen (1975) to explain and predict human behavior that takes place in a given context. Although it is a theory based on social psychology, it is widely used to explain behaviors that fall under the field of many different disciplines. The theory states that there are three main factors affecting behavioral intention, which reflects the individual's readiness to perform the behavior. These; It is expressed as "attitude towards behavior, personal norms (perceived social pressure) and perceived behavioral control" (Öztürk et al., 2015: 146). In this study, the variables affecting the consumers' intention to purchase halal certified products and especially the product categories they prefer were investigated. In the realization of this aim, a questionnaire determined based on the theory of planned behavior, which is one of the behavioral models, was used and data were collected by face-to-face interviews with 742 participants who were determined by easy sampling. SPSS program was used in the analysis of the data. Relevant hypotheses were tested by using analysis methods such as reliability, correlation, regression, t-test and Anova. As a result of the analyzes, it has been seen that there is a positive and significant relationship between "Religiousness", "Subjective Norms", "Attitude towards Behavior" and Perceived Behavior Control between "Intention to Purchase Halal Certified Products". It has been seen by the t-test and Anova analyzes that the state of agreement with the statements given for halal certified products does not show a significant difference according to demographic variables of the participants.

## **2.Literature Review**

Yorulmaz and Akçi (2020) found significant differences between demographic variables in their studies in which they investigated the attitudes of consumers living in Adıyaman towards halal certified products. When the age range is examined in the study, the participants in the 36-50 age group show more sensitivity to halal certified food products than other age groups. The reason for this finding in the study was stated that the marital status of the participants in this age range was also different and that the married participants were more sensitive about consuming halal food. (Yorulmaz and Akçi, 2020: 1234).

Yılmaz and Albayrak (2021), examined which factors affect the halal purchasing intentions of Turkish consumers from different generations

living in Samsun and Cologne in their study. As a result of the analyzes made by using the Structural Equation Model (SEM), it was found that “religiousness, perceived behavioral control, attitudes towards halal food, halal awareness and subjective norms of consumers living in both cities are positively and highly effective on halal food purchase intention” (Yılmaz and Albayrak, 2021: 2191).

Abbasov (2020) applied a questionnaire to 499 people in the Buca district of İzmir to investigate whether there is a meaningful relationship between the demographic characteristics of consumers and their religious beliefs, perceptions and preferences for halal certified products. Reliability, correlation and regression analyzes were used to analyze the data in the study. As a result of the research, no significant difference was found between the consumers’ perception of halal product satisfaction and the monthly income, educational status and marital status of the participants. In addition to these, it was concluded that there is a significant difference between the perception of halal product satisfaction and the perception of halal product preferences (Abbasov, 2020).

Alagöz and Demirel (2017) applied a questionnaire to 330 people in order to determine the intention of consumers about purchasing halal certified products and investigating the reasons affecting consumer behavior in Konya. As a result of the correlation and regression analyzes conducted in the research, a significant relationship was found between attitude towards behavior, subjective norms and perceived behavioral control and the intention to purchase halal certified products. However, no significant relationship was found between the religiosity factor and the intention to purchase halal certified products (Alagöz and Demirel, 2017: 451).

Hassan and Awang (2009) conducted a study with restaurant owners in New Zealand using a survey method. A total of 99 businesses owners/managers participated in the research through snowball sampling. Upon the difficulties of the minorities in the country to find halal products they were asked whether they want to get an halal certification and use it in their restaurant or not? in the study. The majority of the managers stated that the Muslim market does not constitute an important place for their sector, so they do not intend to use these applications (Hassan and Awang, 2009: 385).

Restaurants and food outlets were examined in the research conducted by Alhabshi (2013) in British Columbia (British Columbia, a province where people from almost every ethnicity and religion live). In the research, halal applications at these sales points were examined and it was tried to determine the motivations that caused these applications to

increase. Looking at the results of the research, it has been determined that halal food products can be easily found in BC, especially in regions where Muslims live heavily. It has also been seen that there are various Muslim shops with many haram products. The role of the halal certificate issuer in this region has remained insignificant due to the low promotion of the halal logo and certificate. However, it is stated that the expectations of consumers with high halal sensitivity, especially from Muslim stores, are high (Alhabshi, 2013: 847).

Kızılkaya (2017) interviewed 382 participants by using the survey method to determine the consumer trends towards halal food in Turkey. According to the results obtained in the study, it has been determined that there is a certain sensitivity towards the use of halal food in Turkey. Factors such as consumers' religious sensitivities and trust in the business affect the orientation to halal certified products. In the study, "monthly income", one of the demographic variables, was determined as another factor that has a significant effect on the preference of halal food (Kızılkaya, 2017: 88-89).

Avcı and Koroğlu (2021) examined the effect of consumers' religiosity on their intention to purchase halal food and the mediating roles of knowledge about halal food and the importance given to halal food in this relationship. At the end of their analysis, it was found that the knowledge about halal food and the importance given to halal food have a partial mediating effect on the effect of religiosity on the intention to buy halal food; however they determined that the knowledge about halal food has a more mediating effect than the importance given to halal food (Avcı and Koroğlu, 2021: 360).

Demirağ, Çavuşoğlu and Dağ (2020) aimed to reveal the structural relationship between religiosity, attitude and behavioral intention to purchase halal food labeled products. In this context, interviews were conducted with 408 Muslim consumers living in Germany. According to the results of the analysis, it was determined that religiosity positively affects attitudes and behavioral intentions towards purchasing halal food labeled products. Similarly, in the study, it was concluded that attitudes towards purchasing halal food labeled products positively affect behavioral intentions (Demirağ et al., 2020: 3405).

Güzel (2018) conducted a survey on halal food certification and consumer behavior in Turkey and England. As a result of the research, there was no significant difference in halal food attitudes and preferences between the participants living in Turkey and England, since almost all of the participants in the research were Muslim and their demographic characteristics were the same. In this respect, a single structural equation

model was created in the study. The validity and reliability of all scales related to the constructed structural model were proven by applying linear factor analysis. In addition, at the end of the research, a model and scale was proposed to determine the behavior of consumers towards halal food (Güzel, 2018: 242).

Öztürk, Nart, and Altunışık (2015) carried out the first study in Turkish literature examining halal purchasing behaviors using the “Planned Behavior Theory”. The study also sought answers to the following questions: “How do consumers living in Turkey define the concept of halal product? - How are the attitudes of consumers living in Turkey towards halal products reflected in their purchasing behavior? - Is there a difference between the attitudes of consumers for different product groups such as cosmetics, food and cleaning, and if so, in what direction? - In addition to religious sensitivities, do consumers generalize that halal consumption is healthy and conscious consumption? Within the scope of these purposes, an online questionnaire was prepared for the members of a group created on social media related to halal consumption, and the data of 202 participants were obtained and related analyzes were made. In the analysis results; It has been determined that the variables in the Planned Behavior Theory Model explain consumers’ intentions and behaviors towards purchasing halal products. It has been seen that the attitude developed by consumers on behavioral intention and intentions on actual behavior are the most determining variables. In the food, cosmetic and cleaning product groups, it was determined that the participants gave the most importance to the halal feature of the food products. In addition, it has been determined that halal products are perceived as more reliable, healthy and clean, as they are produced in accordance with the rules of the Islamic religion (Öztürk et al., 2015: 141-145).

Hall and Sevim (2016) prepared a quantitative survey within the scope of planned behavior theory to explain the determinants of halal food consumption of Muslim immigrants and applied it to Turkish immigrants. At the end of the study, it was seen that the attitude in terms of purchasing halal food significantly and directly affects the behavioral intention (Hall and Sevim, 2016: 36).

Hacıhasanoğlu et al. (2018) conducted a survey study to determine the perceptions, attitudes and expectations of students studying at Bozok University about halal products. In the study, the differences in the attitudes of the demographic variables towards halal products were also investigated. When the data obtained in the study were analyzed using one-way Manova analysis, there was no significant difference between demographic variables such as age, gender, average monthly expenditure and monthly income of the family, while the expressions related to halal



products were analyzed in terms of halal product knowledge level and faculty variables. It was determined that the results differed (Hacıhasanoğlu et al., 2018: 129).

Pamukçu and Sarıışık (2017) conducted a content analysis with a qualitative approach in order to examine halal tourism as a touristic product and to investigate its value in the world and the situation of countries that implement halal tourism in the world. Developments and data on halal tourism were evaluated within the scope of world countries in the study. It has been stated that adequate strategy and policy in the field of halal tourism has not been determined for our country, which has great advantages in halal tourism (Pamukçu and Sarıışık, 2017: 94).

Torlak (2012), made a conceptual evaluation on the potential of halal product marketing, the problems experienced in the sector and the solutions offered. He explained these concepts and main problems in halal product marketing under the headings “Lack of Trust”, “Certification Problems”, and “Marketing and Promotion Gaps” in his study.

Tatlı, Erdem and Arpacık (2017) regarding the concepts of halal food and halal consumption; conducted a survey with 400 household heads in Bingöl in order to determine the awareness, attitudes and expectations of consumers. By using factor analysis in the analysis of the survey data, it was stated that six factors were effective in explaining the behavior of consumers. These factors in the study; reliability, price, certification, health, promotion and supply (Tatlı et al., 2017: 37).

Kızgın and Özkan (2014) conducted a study to determine the factors affecting consumers’ consumption of halal certified products and to raise awareness about these products. As a result of the study, it is seen that gender, ready-to-eat food and consumption habits have an effect on the tendency of the participants to consume halal certified; It was observed that other demographic variables such as age, income level and marital status had no effect. In the research, the participants marked the “chocolate” option the most for the product that was most considered to be halal certified, followed by products such as ketchup and mayonnaise in the second place (Kızgın and Özkan, 2014: 18-34).

### **3.A Research On Consumer Behaviors For Halal Certified Products**

#### **3.1.Purpose Of The Study**

The aim of the research is to determine the effect of consumer attitudes towards halal certified products on purchase intention. In addition to this, in which product categories the halal certificate is most demanded by consumers was also investigated in the study.

### 3.2.Method

Survey data were collected in a three-month period covering January, February and March 2019 by conducting face-to-face surveys with 742 people through convenience sampling, one of the non-probability sampling methods. A 5-point Likert scale was used for the first 2 questions in the research questionnaire. The statements that make up the 1st Question: Attitude Towards Behavior, Perceived Behavior Control, Subjective Norms, Purchasing Intention and Religiosity consist of a total of 26 statements. For these questions, the scale used by Alagöz and Demirel (2017), one of the previous similar studies in the literature, was used with their approval. The second question was asked in order to determine the products for which the Halal Certificate is mostly checked. The other 6 questions were asked to determine demographic variables such as gender, age, income, occupation, education and place of residence. The models and hypotheses used in the research can be seen below.

#### **Research Hypotheses:**

**H<sub>1</sub>:** *There is a significant relationship between consumers' attitudes towards halal certified products and intention to purchase halal certified products.*

**H<sub>2</sub>:** *There is a significant relationship between the subjective norms of the consumers for the halal certified products and the intention to purchase the halal certified products.*

**H<sub>3</sub>:** *There is a significant relationship between consumers' perceived behavior control towards halal certified products and intention to purchase halal certified products.*

**H<sub>4</sub>:** *There is a significant relationship between the religiosity levels of the consumers and the intention to purchase halal certified products.*

### 4.Findings

#### **Demographic Characteristics of Participants**

742 people participated in the study. 51.2% (380 people) of the participants were men and 48.8% (362 people) were women.

**Table 1.** *Gender Status of Participants*

<b>Gender</b>	<b>Frequency</b>	<b>Percent</b>
Man	380	51,2
Woman	362	48,8
Total	742	100,0

While 454 people, (61.2% of the participants) stated that they were “single”, 287 people, (38.3%,) stated that they were “married”.

**Table 2.** *Marital Status of Participants*

<b>Marital Status</b>	<b>Frequency</b>	<b>Percent</b>
Single	454	61,2
Married	287	38,3
Total	742	100

Looking at the age distribution of the participants, it is seen that nearly half of the participants in the research are between the ages of 18-24. This is followed by the participants in the age range of “25-34” with 18.2% and “35-44” with 17.5%.

*Tablo 3. Age Status of The Participants*

AGE	Frequency	Percentage
<b>18-24</b>	<b>367</b>	<b>49,5</b>
<b>25-34</b>	<b>135</b>	<b>18,2</b>
<b>35-44</b>	<b>130</b>	<b>17,5</b>
45-54	67	9,0
55-64	29	3,9
65 and over	14	1,9
Total	742	100,0

In the next question, the participants were asked to indicate their educational status. While 235 people, who make up 31.7% of the participants, stated that they were “High school graduates”, this was followed by the answer of “Associate Degree” with 27.4% (203 people) and “Bachelor’s degree” with 16.3% (121 people).

**Table 4.** *Educational Status of Participants*

<b>Educational Status</b>	<b>Frequency</b>	<b>Percentage</b>
Primary education	77	10,4
secondary education	72	9,7
High School	235	31,7
Vocational degree	203	27,4
University Graduated	121	16,3
Master	28	3,8
Other	6	,8
Total	742	100,0

Considering the occupational status of the participants, 339 people, who make up 45.7% of the participants, stated that they were *students*,

while 117 people who made up 15.8% of them were *workers* and 73 people who made up 9.8% stated that they were *private sector employees*.

*Table 5. Occupational Status of Participants*

<b>Occupation</b>	<b>Frequency</b>	<b>Percentage</b>
Student	339	45,7
Officer	31	4,2
Private Sector Employee	73	9,8
Employee	117	15,8
Retired	37	5,0
Self-employment	27	3,6
Academician	4	,5
Teacher	10	1,3
Not working	72	9,7
Other ( Craftsman )	32	4,3
Total	742	100,0

When the average monthly household incomes of the participants (research data were collected in the first quarter of 2019) are examined, it is stated as “1600 TL or less” with 25.5% of 189 people, followed by 1601-2000 TL with 178 people who make up 24%. In the third place, 144 people constituting 19.4% are seen as “2001-2500 TL”. It is possible to say that the majority of the participants are from the middle and low-income group.

**Table 6. Average Monthly Household Income of Participants**

Monthly Average Household Income TL	Frequency	Percentage
1600 TL or less	189	25,5
1601-2000	178	24,0
2001-2500	144	19,4
2501-3000	70	9,4
3001-3750	76	10,2
3751-4500	35	4,7
4501 and over	50	6,8
Total	742	100,0

The research was carried out in Bilecik and neighboring provinces such as Eskişehir, Bursa, Sakarya, İstanbul and Kocaeli. While the most participants were from Bilecik provinces and districts with 412 people making up 55.5%, Eskişehir with 135 people constituting 18.2% and İstanbul with 73 people constituting 9.8% of all locations.

**Table 7. Residency of The Participants**

City of Residence	Frequency	Percentage
Bilecik	412	55,5
Eskişehir	135	18,2
Bursa	51	6,9
Sakarya	21	2,8
İstanbul	73	9,8
Kocaeli	50	6,7
Total	742	100,0

#### 4.1. Reliability Analysis

In the first question of the study; reliability analysis was conducted for the statements consisting of variables in the planned behavior theory model such as “purchase intention, religiosity, attitude towards behavior, subjective norms and perceived behavioral control”. Since the calculated Cronbach Alpha values were greater than 0.70, the data were found reliable enough for the analysis. The calculated values can be seen below in table 8 and table 9.

**Table 8. Reliability Analysis (Cronbach Alpha)**

Reliability Analysis		
Cronbach's Alpha	Cronbach's Alpha Based on Standardized Items	N of Items
,935	,936	26

**Table 9. Reliability Analysis for Variables**

	Cronbach's Alpha Value when expression is deleted
Attitude Towards Behavior for 7 statements Cronbach's Alpha: ,816	
Halal certification is a good idea.	,935
I always follow the newly released halal certified products.	,934
I prefer halal certified products over non-halal certified products.	,933
I think everyone should buy halal certified products.	,932
Halal certified products are of higher quality than non-halal certified products.	,933
I research new halal certified brands.	,934
I am willing to go long distance to buy halal certified products.	,933
Perceived Behavior Control for 5 statements Cronbach's Alpha: ,845	
I am ready to purchase halal certified products in the future.	,932
I prefer halal certified products when purchasing daily necessities.	,932
I will regularly buy halal certified products if available.	,931
Even if the brand of halal certified product is not very popular, I prefer to buy it.	,933
I buy halal certified products even if they are a bit expensive.	,932
Subjective Norms for 4 statements Cronbach's Alpha: ,814	
Family members want to buy halal certified products.	,933

My friends will support my thoughts on purchasing halal certified products.	,933
My friends also want to buy halal certified products.	,932
People who are important to me will support me in my decision to purchase halal certified products.	,932
Purchasing Intent for 4 expressions Cronbach's Alpha: ,710	
Halal certified products I can afford to buy if they are a bit expensive.	,933
It is only my decision to buy or not to buy halal certified products.	,937
If halal certified brands are available in existing markets, I would definitely buy halal certified brands.	,932
I have knowledge to buy halal products.	,934
Religiosity for 6 expressions Cronbach's Alpha: ,863	
I spend time catching up with religious understanding.	,933
What lies behind my religious beliefs is the understanding of my entire life.	,933
Religious beliefs affect all the relationships of my life.	,933
Spending time with private religious thoughts and prayers is important to me.	,933
I enjoy taking part in religious activities.	,934
Advice from my religious friends influences my decisions.	,934

#### 4.2. Correlation Analysis

In the study, whether there is a significant relationship between the statements about Halal purchase intention and the predetermined "Intention to Purchase Halal Certified Products" dependent variable and other variables was checked with the help of Correlation Analysis. The findings obtained as a result of the analysis are shown in Table 10 below.

**Table 10.** *Correlation Analysis*

	<b>Purchasing Intent (r)</b>	<b>Sigma</b>
Religiosity	0,508**	0,000
Subjective Norms	0,651**	0,000
Attitude Towards Behavior	0,587**	0,000
Perceived Behavior Control	0,656**	0,000

**\*\* Since the correlation value sigma is less than 0.01, it is two-sided.**

As seen in table 10; a positive and significant relationship was found between the dependent variable of "Intention to Purchase Halal Labeled Product" and "Religiousness", "Subjective Norms", "Attitude towards Behavior" and Perceived Behavior Control.

#### 4.3. Regression Analysis

Regression analysis is an important statistical technique used for data analysis in many fields and is used to explain the relationship between variables. Thanks to this analysis, it is possible to explain the relationship between a dependent variable and the independent variable or variables that are thought to have an effect on it, with a mathematical model. Simple

Linear Regression model ( $Y=a+bX$ ) is used when there is one independent and one dependent variable. However, multiple linear regression analysis ( $Y=a+bX_1+cX_2+dX_3+\dots$ ) is used when there is one dependent and two or more independent variables. In both models, there is a linear relationship between the variables (Ural and Kılıç, 2005: 253).

**Table 11. Regression Analysis Results**

Model Summary									
Model	R	R Square	Adjusted R Square	Std. Error of the Estimate	Change Statistics				
					R Square Change	F Change	df1	df2	Sig. F Change
1	<b>.720<sup>a</sup></b>	<b>.518</b>	<b>.516</b>	,53430	,518	198,318	4	737	,000
a. Predictors: (Constant), RELIGIOUSNESS, SUBJECTIVE NORMS, ATTITUDES TO BEHAVIOR, PERCEIVED BEHAVIOR CONTROL									

ANOVA <sup>b</sup>						
Model		Sum of Squares	df	Mean Square	F	Sig.
1	Regression	226,463	4	56,616	<b>198,318</b>	<b>,000<sup>a</sup></b>
	Residual	210,399	737	,285		
	Total	436,862	741			
a. Predictors: (Constant), RELIGIOUSNESS, SUBJECTIVE NORMS, ATTITUDES TO BEHAVIOR, PERCEIVED BEHAVIOR CONTROL						
b. Dependent Variable: PURCHASE INTENTION						

Coefficients <sup>a</sup>								
Model		Unstandardized Coefficients		Standardized Coefficients		Sig.	95,0% Confidence Interval for B	
		B	Std. Error	Beta	t		Lower Bound	Upper Bound
1	(Constant)	<b>1,185</b>	,100		11,856	<b>,000</b>	,989	1,381
	Attitude Towards Behavior	<b>,088</b>	,037	,095	2,348	<b>,019</b>	,014	,161
	Perceived Behavior Control	<b>,236</b>	,036	,288	6,608	<b>,000</b>	,166	,306
	Subjective Norms	<b>,264</b>	,032	,316	8,324	<b>,000</b>	,202	,327
	Religiosity	<b>,115</b>	,028	,133	4,158	<b>,000</b>	,061	,170
a. Dependent Variable: Intention to Purchase Halal certified product								

As a result of the regression analysis, when the purchase intention was the dependent variable, a significant relationship was found between the other variables as the p value was calculated as less than 0.05. Accordingly, it is seen that the variable of intention to purchase halal products is explained by the variables of religiosity, attitude towards behavior, subjective norms and perceived behavioral control (since  $R^2 = 0.516$ ) at 51.6%. The mathematical formula created in accordance with the research model is:

$$Y = 1.185 + 0.088X_1 + 0.236X_2 + 0.264X_3 + 0.115X_4$$

When the variables are written into the formula, they can be expressed as follows:

***Halal Certified Intention to Purchase = 1,185 + 0.088 Attitude towards Behavior + 0.236 Perceived Behavior Control + 0.264 Special Norms + 0.115 Religiousness***

According to the results of the analysis, the hypotheses given in the title of research method were accepted.

***H<sub>1</sub>: There is a significant relationship between consumers' attitudes towards halal certified products and intention to purchase halal certified products. (accepted)***

***H<sub>2</sub>: There is a significant relationship between the subjective norms of the consumers for the halal certified products and the intention to purchase the halal certified products. (accepted)***

***H<sub>3</sub>: There is a significant relationship between consumers' perceived behavior control towards halal certified products and intention to purchase halal certified products. (accepted)***

***H<sub>4</sub>: There is a significant relationship between the religiosity levels of the consumers and the intention to purchase halal certified products. (accepted)***

#### **4.4. Products that Participants Check for Halal Certification Before Purchasing**

In the second question of the study, the participants were asked to answer the products that they checked for halal certificate "before purchasing" according to a 5-point Likert scale.

**Table 11.** *Products Purchased Whether Or Not They Have Halal Certificate*

PRODUCTS	Never	Rarely	Occasionally	Quite often	Always	Total
Chocolate Frs	176	121	189	93	163	742
%	23,7	16,3	25,5	12,5	22,0	100,0
Biscuit Frs	189	118	186	127	122	742
%	25,5	15,9	25,1	17,1	16,4	100,0
Fast-Food products Frs	119	83	160	148	232	742
%	16,0	11,2	21,6	19,9	31,3	100,0
Frozen foods Frs	95	83	146	165	253	742
%	12,8	11,2	19,7	22,2	34,1	100,0
Processed Meat Products Frs	62	44	93	147	396	742
%	8,4	5,9	12,5	19,8	53,4	100,0



Cosmetic Products	<b>221</b>	116	161	93	151	742
Frs %	<b>29,8</b>	15,6	21,7	12,5	20,4	100,0
Medical Drugs and Vaccines	<b>198</b>	101	130	109	204	742
Frs %	<b>26,7</b>	13,6	17,5	14,7	27,5	100,0
Soft Drinks, Water, Juice	<b>185</b>	86	125	118	228	742
Frs %	<b>24,9</b>	11,6	16,8	15,9	30,7	100,0

As it can be seen in the Table 11, more than half of the participants (53.4%) (396 people) stated that they “ALWAYS” check whether processed meat products have halal certificate before purchasing, while 253 people (34.1%) come second with Frozen foods and thirdly, it was observed that fast-food products were checked “always” with 232 people (31.3%). The products that the participants “NEVER” controlled were Cosmetic products with 221 people (29.8%), Medicinal drugs and vaccines with 198 people (26.7%), and Soft drinks, fruit juice and water come thirdly with 185 people (24.9%).

### 5. Conclusion

The relationship between the variables affecting the consumers’ intention to purchase halal certified products was investigated through a questionnaire determined based on the theory of planned behavior, one of the behavioral models in the study. In addition to this purpose, the product categories that consumers check for halal certification before purchasing have also been determined.

As a result of the Correlation and Regression analyzes, a significant relationship was found between the dependent variable “Intention to Purchase Halal Certified Products” and other variables such as subjective norms, attitude towards behavior, perceived behavior control and religiosity. The hypotheses shown in the research model were accepted.

In the general finding analyzes for the second question of the research, it was determined that more than half of the participants (53.4%) (396 people) “ALWAYS” check whether they have halal certificate before purchasing Processed Meat products, Frozen foods come to second place by 253 people (34.1%) and it is followed by Fast-food products with 232 people (31.3%) which is in third place. The products that the participants “NEVER” control were cosmetic products with 221 people (29.8%), Medicinal drugs and vaccines with 198 people (26.7%), and Soft drinks, fruit juice and water with 185 people (24.9%).

There were no significant differences between the degrees of participation of the demographic variables in the statements about the factors related to halal certified products, since the averages of the answers given by the demographic variables to the statements about the factors

determining the consumer behavior towards halal certified products were very close to each other and the numbers of the demographic variables were not suitable enough for comparison in the study.

The results obtained are consistent with previous studies. In the study of Hall and Sevim (2016), similar to the findings in this study, it was seen that the attitude in terms of purchasing halal food significantly and directly affects behavioral intention. Attitude factor, subjective norms and perceived behavior control factors developed on the basis of planned behavior theory in Alagöz and Demirel's (2017) studies also positively and significantly affected the intention to purchase halal certified products, similar to the results of this research. However, the findings in the two studies differ in terms of the religiosity factor. However, the findings in the two studies differ in terms of the religiosity factor. In this study, while the religiosity factor had a significant and positive relationship with the intention to purchase halal certified products, no significant relationship was found in the other research. Öztürk et al. (2015) in their study, similar to this study; They revealed that the variables in the Planned Behavior Theory Model explain consumers' intentions and behaviors towards purchasing halal products. Among the findings of the study, the effect of the religiosity factor on the purchase intention of halal certified products was also similar to the mediating effect of religiosity on the purchase intention of Avcı and Koroğlu (2021).

Because of the global pandemic, it is becoming more and more important that the products produced in many sectors are hygienic, clean and healthy. Products with halal certificate can be preferred by consumers with religious sensitivities and also because of the other benefits they provide. In the research findings, it has been observed that consumers prefer halal certified products, especially in processed meat products. Since the world halal food market is estimated to reach 3 Trillion Dollars by 2023, the importance of the sector will increase day by day. Therefore, it may be possible for businesses that turn to the halal product sector or increase their investments to benefit from this growing market. It is hoped that the results of the research will benefit businesses, academics, consumers and lawmakers who are interested in the sector.

## REFERENCES

- Abbasov K., (2020). *Tüketicilerin Helal Sertifikalı Ürünlere Karşı Tutumlarının Belirlenmesine Yönelik Bir Araştırma*, Dokuz Eylül Üniversitesi Sosyal Bilimler Enstitüsü İşletme Anabilim Dalı Girişimcilik Programı, İzmir.
- Alagöz, B., S. Ve Demirel, E. (2017). *Helal Gıda Sertifikalı Ürünlerin Tüketici Davranışları Üzerine Etkisi: Konya İli Üzerinde Bir Araştırma*, *Journal of Süleyman Demirel University Institute of Social Sciences*, 28(3), 451-472.
- Alhabshi, S. M. (2013). HALAL FOOD DILEMMAS: CASE OF MUSLIMS IN BRITISH COLUMBIA, CANADA *International Journal of Asian Social Science*, 2013, 3(4):847-870
- Avcı, İ., Köroğlu, A. (2021). “Dindarlığın Helal Gıda Satın Alma Niyeti Üzerindeki Etkisinde Helal Gıdaya Yönelik Bilgi ve Helal Gıdaya Verilen Önemin Aracılık Rollerinin İncelenmesi”, *Eskişehir Osmangazi Üniversitesi İİBF Dergisi*, 16(2), 360 – 380.
- Çallı, İ. D. (2014), Etnik Pazarlamada Helal Kavramının Kullanımı “Almanya’da Yayınlanan Gıda Reklamları Üzerine Bir İnceleme”, *Anadolu Üniversitesi Sosyal Bilimler Dergisi*, Cilt/Vol.: 14 - Sayı/No: 4 (43-56)
- Çöp, S., Çakmak, M. & Köklü, O. (2021). Helal Gıda Sertifikalarına Yönelik Bir Araştırma, *Helal ve Etik Araşt. Derg. / J. Halal & Ethical Res.* 3 (2): 47-65.
- Demirağ B., Çavuşoğlu, S. & Dağ, K. (2020), *Dindarlık, Tutum ve Davranışsal Niyetler Arasındaki İlişkinin İncelenmesi: Almanya’daki Müslüman Tüketicilerin Helal Gıda Etiketli Ürünlere Yönelik Algılarının VAB Modeli İle İncelenmesi*, *İşletme Araştırmaları Dergisi*, 2020, 12(4), 3405-3420.
- Güzel Y., (2018). *Gıda Sektöründe Helal Sertifikalı Ürünlerin Tüketici Tercih Ve Davranışlarına Olan Etkisi*, Türkiye-İngiltere Karşılaştırması, *T.C. Kırıkkale Üniversitesi Sosyal Bilimler Enstitüsü İşletme Anabilim Dalı*, Yayınlanmamış Doktora Tezi.
- Hacıhasanoğlu, P., Kara, M. Ve Hacıhasanoğlu, T. (2018). Üniversite Öğrencilerinin Helal Ürün Algı, *Tutum Ve Beklentileri: Bozok Üniversitesi Örneği Ekonomik ve Sosyal Araştırmalar Dergisi*, Cilt 14, Yıl 14, Özel Sayı, 2018, ss. 129-146.
- Hall, E. E., ve Sevim, N. (2016). Halal food consumption intention by Turkish immigrants, *International Journal of Business and Management Invention*, 5(11), 36-40.
- Hassan, W. M. & Awang, K. W. (2009). *Halal Food in New Zealand Restaurants: An Exploratory Study*, *Int. Journal of Economics and Management* 3(2): 385 – 402.
- Kızgın, Y. ve Özkan, B. (2014). *Tüketicilerin Helal Gıda Tüketim Eğilimlerinin Belirlenmesine Yönelik Bir Çalışma*, *Uluslararası İşletme Ve Yönetim Dergisi C.:2 S.:1 Yıl:2014*, Ss. 18-37

- Kızılkaya, B. (2017). Türkiye’de Helal Gıda Konusundaki Tüketici Eğilimlerinin Belirlenmesine Yönelik Bir Araştırma, *T.C. Muğla Sıtkı Koçman Üniversitesi, Sosyal Bilimler Enstitüsü İşletme Anabilimdalı Yayınlanmamış Yüksek Lisans Tezi*.
- Öztürk, A. (2022). *The effect of halal product knowledge, halal awareness, perceived psychological risk and halal product attitude on purchasing intention*. Business and Economics Research Journal, 13(1), 127-141.
- Öztürk, A., Nart, S., ve Altunışık, R. (2015). Tüketicilerin Helal Tüketim Davranışlarının Belirleyicileri: Planlı Davranış Teorisi Çerçevesinde Bir Araştırma, *International Journal of Islamic Economics and Finance Studies, 2015, Year:1, Volume:1, Number: 2*
- Pamukçu, H. ve Sarıışık M. (2017). Helal Turizm Kavramı Ve Gelişimi Üzerine Genel Bir Değerlendirme, *Uluslararası İktisadi Ve İdari Bilimler Dergisi Özel Sayı 1, 2017, 82-98*.
- Tatlı, H., Erdem, M., ve Arpacık, M. (2017). Tüketicilerin Gıda Tüketiminde Helal Gıda Farkındalığı Ve Tutumu: Hanehalkı Reisleri Üzerine Bir Uygulama Organizasyon Ve Yönetim Bilimleri Dergisi Cilt 9, Sayı 2, 2017 Issn: 1309 -8039
- Torlak, Ö. (2012). İslam Ülkeleri Arasında Helal Ürün Pazarlama Potansiyeli, Problemleri ve Çözüm Önerileri Tüketici ve Tüketim Araştırmaları Dergisi, Cilt 4 Sayı 2, Aralık 2012, 1-10.
- Ural, A. ve Kılıç, İ. (2005). Bilimsel Araştırma Süreci ve SPSS İle *Veri Analizi, Genişletilmiş 2. Baskı Detay Yayıncılık, Ankara*.
- Yorulmaz, D. Ö. & Akçi, Y. (2020). Helal Gıda Tüketimine Yönelik Tutumların Satın Alma Niyeti Üzerindeki Etkisi (Adıyaman Örneği), *Kahramanmaraş Sütçü İmam Üniversitesi Sosyal Bilimler Dergisi, 17 (2), 1218-1238*.
- Yılmaz, M. K. Ve Albayrak, İ. C. (2021). Kuşakların Helal Gıda Satın Alma Niyetlerinin Planlı Davranış Teorisi Bağlamında İncelenmesi: Samsun-Köln Örneği, *Uluslararası Toplum Araştırmaları Dergisi-International Journal of Society Researches, Yıl Year : 11, Cilt Volume :18, Sayı Issue :40*.

“

## Chapter 16

### **CRYPTOCURRENCY USER PROFILE AND PROBLEMATIC CRYPTOCURRENCY USAGE FREQUENCY IN TURKISH SOCIETY**

*Nurettin MENTEŞ<sup>1</sup>*

*Mahmut BULUT<sup>2</sup>*

*İlyas YOLBAŞ<sup>3</sup>*

”

1 Nurettin Menteş Dr. Orcid: 000-0002-5650-4342 Department of Finance, Banking and Insurance, İnönü University Malatya MYO, Malatya Turkey

2 Mahmut Bulut PROF. DR. Orcid: 0000-0002-6008-378X Department of Psychiatry, Dicle University School of Medicine, Diyarbakır, Turkey

3 İlyas Yolbaş Prof. Dr. Orcid: 000-0001-9978-9694 Department of Pediatrics, Public Health, Dicle University School of Medicine, Diyarbakır, Turkey

## Introduction

From primitive economies to today, it has been observed that individuals exchange their surplus resources with products they need. A barter economy has the feature of protecting the social fabric with its aspect of developing social relations, in addition to meeting the needs. In societies where money is not functional and is not used as an element of exchange, bartering forms the basis of analyses regarding economic activities, within a narrow framework. When it is comprehensively considered, a barter economy contains deep relations from simple commercial transactions without any profit motive to a market economy with large-scale economic affairs (Nar, 2019) (Bates & Aydın, 2009) (Chapman, 1980) (Polanyi & Buğra, 2013). Barter, which was the form of trading in older periods, left its place to precious metals such as gold and silver in time. Gold and silver started to be used in different parts of the world for exchange, as means of payment or as stores of value (Çarkacıoğlu, 2016). However, with the changing conditions, paper money has become an element of trade along with precious metals. The history of money, which is nearly as old as the exchange of goods and services, has been well-documented; however, it is the most common yet the least understood of human innovations (Balvers & McDonald, 2021). Paper money<sup>1</sup>, which started its historical journey first in China, has later begun to be used in Europe in the 15<sup>th</sup> century. It was printed in Europe for the first time in 1661 by the official authority and its use was encouraged in the following centuries. Paper money continued to be printed based on gold for a long time. This system<sup>2</sup>, in which the value of paper money of a country was directly linked to gold, was replaced by fiat money after a while. Over the last century, fiat money, a currency that is not backed by physical commodities and is accepted by the government as legal money, has become the dominant form of what is considered money in today's central market economies, along with bank money (Balvers & McDonald, 2021). However, recently, changes have occurred in the money markets due to technological developments and changing human needs. Credit cards and mobile banking activities restricted the use of money. With the help of the internet, individuals are able to do shopping and make all kinds of monetary transactions from anywhere in the world. Recently emerging digital currencies have a number of software features that has changed this situation. The technical infrastructure of cryptocurrency, a virtual currency based on cryptography, was created by Nakamoto (Nakamoto, 2008). The theoretical framework of cryptocurrency had been developed by Wei Dai in 1998 (Dai, 1998) (Gültekin & Bulut, 2016). The Cypherpunk movement, which was formed

---

1 [Paper money, a Chinese invention? — Museum of the National Bank of Belgium \(nbbmuseum.be\)](https://www.nbbmuseum.be/en/what-is-paper-money-a-chinese-invention/)

2 [What is the Gold Standard? \(investopedia.com\)](https://www.investopedia.com/terms/g/gold-standard/)

by some informaticians who advocated the privacy of digital transactions, suggested that with a properly designed encryption, many economic transactions could be removed from the control of central authorities. In his work on an anonymous and distributed electronic cash system, Dai, who was a member of the cypherpunk movement, introduced a system called “b-money” (Dai, 1998), where a group of people with untraceable digital pseudonyms could make payments to each other without any outside help (Tetik & Ahmet, 2020). It can be said that cryptocurrencies were first used in the e-Cash payment system (Tetik & Ahmet, 2020). This system, which was based on blind signatures (Chaum), provided users with limited privacy and in the case that a payment was returned, the identity of the user would be known. In addition, the e-Cash system required a central authority (Franco, 2014). In summary, this was the antecedent process of cryptocurrency technology that later disabled the central authority. The first cryptocurrency was Bitcoin, which was proposed in an article published by Nakamoto (Nakamoto, 2008). While Bitcoin has three main roles in financial markets as a medium of exchange, a store of value and an investment tool (Kwon, 2021), it can also be considered a currency since it is used as a medium of exchange on a global scale (Whelan, 2013). When it first came out, Bitcoin had a limited number of users. However, it has become an investment tool that is used extensively in different fields over time. Cuthbertson has reported that more than one hundred thousand retailers use Bitcoin as a means of payment for goods and services (Cuthbertson, 2015); Jalali and Heidari have stated that the use of Bitcoin is increasing in restaurants, shopping malls and other large and small businesses in various countries (Jalali & Heidari, 2020). Bitcoin and similar cryptocurrencies have reached more than 50 million users in a very short time since they have been put into circulation; today, they are being traded on more than one hundred exchanges worldwide (Makarov & Schoar, 2020). The increasing interest in cryptocurrencies has brought diversity. Cryptocurrencies, which were limited in number when they first came out, now contain a lot of derivative instruments of investment (Farell, 2015). Currently, there are 9542 cryptocurrencies that are being traded<sup>3</sup>. Although Bitcoin has been used in illegal activities such as drug trade or illegal online gambling early on (Foley, Karlsen & Putninš, 2019), it has later gained remarkable momentum as an investment tool (H.O. Sonkurt & Altınöz, 2021). Despite the fact that the Bitcoin price has made a horizontal progress for a certain amount of time, there have been rapid fluctuations at various times (Bouri, Shahzad & Roubaud, 2019). The chart below shows the price of 1 Bitcoin in US Dollars by years.

---

<sup>3</sup> <https://coinmarketcap.com/>



*Figure 1: The price of 1 Bitcoin in US Dollars by Years<sup>4</sup>*

As can be seen in Figure 1, there have been serious fluctuations in the price of Bitcoin over the last 5 years. These fluctuations in the price of Bitcoin not only provide high returns (Fink & Johann, 2014) but also cause sudden losses (Songur, 2019). Despite the fluctuations in its price, Bitcoin has gradually become used as an investment tool (H. Sonkurt & Altınöz, 2021). The behaviors of crypto traders investing in high-risk tools may be pathological and these individuals may display behaviors similar to those of gamblers over time (Deck, Lee & Reyes, 2014). For example, in a study by Markovic et al. (2012), the connection between investing on the stock market and addictive behaviors has been examined. They have found that the behaviors of people who invest in stocks, who buy and sell stocks online, match the DSM-IV criteria for addiction (Marković, Nikolac, Tripković, Haluga-Golubović, & Ćustović, 2012). Grall-Bronnec et al. (2017) have found similarities between overtraders and the patterns of pathological gambling behavior. They have stated that overtraders do not act according to a financial plan, that they experience great losses before making a profit and reinvest to compensate for the previous losses and therefore lose control (Grall-Bronnec et al., 2017). Griffiths has suggested that cryptocurrency trading may be a subtype of online day trading addiction or stock market addiction (Griffiths, 2018). Menteş et al. developed the problematic cryptocurrency trading scale, suggesting that cryptocurrency trading may be associated with excessive trading (investing) addiction, stock market addiction and pathological gambling addiction in general (Menteş, Yolbaş, & Bulut). The main purpose of this study is to determine the frequency of cryptocurrency trading and the prevalence of problematic cryptocurrency trading in the society. The reasons for not trading for individuals who have never traded cryptocurrency, and the reasons for discontinuation of trading for individuals who have traded cryptocurrency for a certain amount of time in the past have been investigated.

<sup>4</sup> <https://coinmarketcap.com/tr/currencies/bitcoin>



## Methods

In order to determine the prevalence of problematic cryptocurrency trading, the scale developed by Menteş et al. was used. In addition, questions regarding cryptocurrency investment preferences were added to the survey. Approval for the study was obtained from Dicle University Social Sciences and Humanities Ethics Committee (approval date: 05/11/2021, approval number: 177). The survey for the study was conducted online and 710 voluntary participants were contacted. Participants with incomplete survey data were excluded from the study, and the results of a total of 683 participants were included in the analysis. Demographic findings of the participants are presented in Table 1.

*Table 1: Demographic Characteristics of the Participants*

Characteristics	Category	N (%) or mean $\pm$ S.D
Age (Years)	Age	683 / 35,3455 $\pm$ 10,0269
Gender	Male	472 (69.1)
	Female	211(30.9)
Marital Status	Widowed	15(2.2)
	Married	440(64.4)
	Single	228(33.4)
Educational Status	Primary School	18 (2,6)
	High School	162(23,7)
	Bachelor's Degree	293(42,9)
	Master's Degree	113(16,5)
	Doctorate	97 (14,2)
Alcohol Consumption	Yes	107(15,7)
	No	576(84,3)
Gambling Habit	Yes	9 (1,3)
	No	674 (98,7)
Do you have a psychiatric disorder?	Yes	87 (12,7)
	No	597(87,3)
If yes, are you receiving treatment for your psychiatric disorder?	Yes	76(87,3)
	No	11(12,7)

69.1% of the participants were male and 30.9% were female. 64.4% were married and 33.4% were single. It was determined that 42% of the participants had a bachelor's degree, 16.5% had a master's degree and 14.2% had a doctorate degree. 15.7% of the participants stated that they consumed alcohol, 1.3% of them had a gambling habit and 12.7% of them stated that they had a psychiatric disorder. Among those who had a gambling habit, 2 participants stated that they believed they were addicts and 1 participant was receiving treatment. The answers given to the questions regarding cryptocurrency trading are summarized in Table 2.

*Table 2: Cryptocurrency Trading Status of the Participants*

Characteristics	Category	N (%)
Have you ever traded cryptocurrency?	Yes	214 (31,3)
	No	469 (68,7)

According to Table 2, 31.3% of the participants stated that they traded cryptocurrency and 68.7% stated that they have never traded cryptocurrency. The answers given by the participants to the questions regarding the reasons for not trading cryptocurrency are summarized in Table 3.

*Table 3: The Reasons for Not Trading Cryptocurrency*

Characteristics	Category	N (%)
What is your reason for not trading cryptocurrency?	I have never heard of it	18 (3,83)
	I don't know how to	37 (7,88)
	I don't trust cryptocurrency trading	221 (47,11)
	I have religious reasons (I don't think it's halal)	151(32,19)
	I don't have time	22 (4,69)
	I don't have money	9 (1,91)
	I'm not interested	7 (1,49)
	No answer	4 (0,09)
	Total	469 (100)

According to Table 3, 3.83% of the participants stated that they did not trade cryptocurrency because they had never heard of it, while 7.8% stated that they knew about cryptocurrencies but did not know how to trade. 47.11% of the participants stated that they did not trust cryptocurrency trading, 32.19% stated that they did not trade cryptocurrency because they believed that it was not halal. 4.9% of the participants stated that they did not have time and 1.91% stated that they did not trade cryptocurrency because they did not have money. 1.49% stated that they were not interested in cryptocurrency trading. Participants were asked whether they were still trading and the reasons for discontinuing were investigated. The results are summarized in Table 4.

*Table 4: Reasons for Continuing/Discontinuing Cryptocurrency Trading*

Characteristics	Category	N (%)
Do you still trade cryptocurrency?	Yes	163 (76,17)
	No	51 (23,83)
	Total	214 (100)

What is your reason for not trading cryptocurrency anymore?	It was taking a lot of my time; I stopped so that my work would not be affected	12(23,53)
	I didn't like it	11(21,57)
	I lost a lot of money	7 (13,73)
	I can't continue because I don't have money	9 (17,64)
	I stopped due to religious reasons	4 (7,84)
	It's not safe	4 (7,84)
	I quit when I made a profit	2 (3,92)
	The company went bankrupt	1 (1,96)
	No answer	1(1,96)
Total		

When the participants who were still trading cryptocurrency were asked whether their investments were active or not, 76.17% answered that their investments were still active. Among the participants who did not trade cryptocurrency anymore, 23.53% stated that they discontinued because it was taking a lot of their time, 21.57% did not like cryptocurrency trading, 17.64% did not have enough money and 13.73% had lost a lot of money. 7.84% of the participants had stopped trading due to religious reasons and 7.4% did not think it was safe. 3.92% of the participants who stopped trading cryptocurrency stated that they quit when they made a profit, and 1.96% stated that they stopped when the company went bankrupt.

In the study, the problematic cryptocurrency trading scale, a 5-point Likert-type scale consisting of 15 items, was administered to the participants. In this case, the lowest total score for the scale items should be 15 and the highest score should be 75. There are studies that use different limits for risk groups according to scale scores. Young used a 6-point Likert-type scale for the internet addiction scale she developed. The lowest score was determined to be zero and the highest score was determined to be 100. According to the scale, those who got a score up to 40 points were considered as normal internet users, above 40 points as problematic internet users, and those who got 70 points and above were considered as severely problematic internet users (Young, 1998). Kim et al. used the classification developed by Young in their study (Kim et al., 2006). In our study, for ease of interpretation, mean scale scores were used and the data set was divided into three groups. In the classification of problematic cryptocurrency trading, participants with a mean score of [0-2.34) was considered to be in the normal group, [2.34-3.67) was considered to be in the risk group and those with a mean score of [3.67-5) was considered to be in the high-risk group. The percentage distribution of these groups is presented in Table 5.

*Table 5: Problematic Cryptocurrency User Groups*

	Frequency	Percentage
Normal Group	166	77,6
Risk Group	43	20,1
High-risk Group	5	2,3
Total	214	100,0

According to Table 5, 77.6% of the participants were in the normal group, 20.1% were in the risk group. 2.3% of the participants were found to be in the high-risk group in terms of problematic cryptocurrency trading. The percentage distribution of the total scores of the scale was as follows: Among the participants who traded cryptocurrency, 8.9% had a total score of 0-16, 61.7% had a total score of 32-48, 6.1% had a total score of 48-64 and 0.9% had a total score of 64-80.

### **Discussion and Conclusion**

Cryptocurrency assets have become an investment tool that is followed with great interest with its increasing social importance (Steinmetz, von Meduna, Ante, & Fiedler, 2021) due to the recently growing transaction volume and number of users (Blandin et al., 2020). The characteristics of cryptocurrency investor profile, the actual frequency and demographics of users have not received as much attention as the development of cryptocurrency. In a study conducted by Steinmetz et al. through an online survey among German cryptocurrency users, it was determined that 83% of the participants knew about cryptocurrency, 9.2% of the participants had crypto assets at the time of the survey, and 9.1% had traded cryptocurrency in the past. In the same study, they found that cryptocurrency users tend to be young, well-educated, and wealthy individuals (Steinmetz et al., 2021). In the study of Postbank (2018), which was conducted with 3100 participants, it was determined that 29% of the participants considered cryptocurrencies as an interesting investment tool. In addition, 4% of the participants stated that they had a very good level of knowledge of cryptocurrencies, and 16% stated that they had a good level of knowledge. 41% of the participants stated that they had little knowledge of cryptocurrencies (Postbank, 2018). In Russia, people who have detailed knowledge of cryptocurrencies constitute 9% of the society (“Wciom,” 2019). In our study, those who stated that they were cryptocurrency traders at the time of the survey, constitute 31.3% of all participants. We think that the rate is high is due to the fact that the majority of the participants are university graduates or have a higher education level. It is likely that this rate will be lower on a different sample. This is one of the limitations of the study. The cryptocurrency investments of 76.17% of the participants who traded cryptocurrency were still active. 23.83% of all participants

were continuing to trade cryptocurrency. Participants who stated that they did not trade cryptocurrency were asked about their reasons for not trading, and almost half of them (47.11%) answered that they did not trust cryptocurrency trading. 32.19% of the participants who did not trade cryptocurrency stated that it was due to religious reasons and they believed it was not halal. Participants who traded cryptocurrency were asked whether their investments were still active and it was determined that 76.17% were continuing to invest and 23.83% were not investing anymore. Among the reasons for those who were not investing in cryptocurrency anymore, the first four items were respectively: they didn't want it affect their work (23.53%), they did not like it (21.57%), they did not have money (17.64%) and they lost a lot of money (13.73%). In this study, it was observed that the majority of participants who did not trade cryptocurrency in general did not trust cryptocurrency trading and believed it was not halal. At this point, the recognition of cryptocurrency trading by central governments may eliminate the trust problem. Addressing the concerns of the Muslim Turkish community may enable those who manage the cryptocurrency trade to reach more investors. In the other part of our study, the survey developed for problematic cryptocurrency trading was administered to the participants; and the users were classified according to the total mean scores obtained. Participants with a mean score of [0-2.34) was considered to be in the normal group, [2.34-3.67) was considered to be in the risk group and those with a mean score of [3.67-5) was considered to be in the high-risk group. Among the participants who were trading cryptocurrency, 20.1% were found to be in the risk group and 2.3% were found to be in the high-risk group in terms of problematic cryptocurrency trading. According to the data published in 2021, the number of cryptocurrency traders in Turkey exceeded 2.4 million (Independent Tükçe, 2021); therefore, it can be stated that the number of problematic cryptocurrency users obtained as a result of our study is substantial. Policy makers should approach the issue from this perspective and develop solution strategies for users in the risk and high-risk groups before bigger problems occur. In addition, this study is valuable due to the fact that it is the first study regarding the identification of problematic cryptocurrency users. If a solution is not provided for problematic cryptocurrency trading, it is likely that bigger problems will occur regarding such users. It is possible to classify making Bitcoin investments with leveraged transactions as gambling behavior (Erdoğan, 2019). In the study of Erdoğan (2019) on this subject, one of the participants provided detailed information and another one explained their experience partially. They stated that they took risks to earn more and therefore invested continuously, as a result, they experienced losses that could not be paid and lost control trying to make up for the losses. Loss of control is likely to cause addiction over time (Erdoğan, 2019). Although

it is not clinically defined as an addiction, problematic cryptocurrency trading (Mentes et al.) has aspects that represent addiction. In this study, the rates of cryptocurrency traders and problematic cryptocurrency traders in Turkish society have been determined. The reasons for not trading for individuals who have never traded cryptocurrency have been investigated. The specified information may provide useful information to health policy makers, cryptocurrency providers and investors.

### **Limitations of the Study**

The survey for this study was conducted online. As a result, educated participants were overrepresented in the population. This is among the limitations of this study.

## REFERENCES

- Balvers, R. J., & McDonald, B. (2021). Designing a global digital currency. *Journal of International Money and Finance*, 111, 102317.
- Bates, D. G., & Aydın, S. (2009). *21. yüzyılda kültürel antropoloji: insanın doğadaki yeri*: İstanbul Bilgi Üniversitesi.
- Blandin, A., Pieters, G. C., Wu, Y., Dek, A., Eisermann, T., Njoki, D., & Taylor, S. (2020). 3rd global cryptoasset benchmarking study. Available at SSRN 3700822.
- Bouri, E., Shahzad, S. J. H., & Roubaud, D. (2019). Co-explosivity in the cryptocurrency market. *Finance Research Letters*, 29, 178-183.
- Chapman, A. (1980). Barter as a universal mode of exchange. *L'homme*, 33-83.
- Chaum, D. Blind signatures for untraceable payments. In advances in cryptology 1983 (pp. 199-203). In: Springer US.
- Cuthbertson, A. (2015). Bitcoin now accepted by 100,000 merchants worldwide. *International Business Times*, 4, 1-23.
- ÇARKACIOĞLU, A. (2016). Kripto-para bitcoin. *Sermaye piyasası kurulu araştırma dairesi araştırma raporu*.
- Dai, W. (1998). B-money. *Consulted*, 1(2012), 412.
- Deck, C., Lee, J., & Reyes, J. (2014). Investing versus gambling: experimental evidence of multi-domain risk attitudes. *Applied economics letters*, 21(1), 19-23.
- Erdoğan, Y. (2019). Kumar Problemleri Yaşayan Bireylerin Kumar Oynamayla İlgili Deneyimlerinin Yorumlayıcı Fenomenolojik Analizi.
- Farrell, R. (2015). An analysis of the cryptocurrency industry.
- Fink, C., & Johann, T. (2014). Bitcoin markets. Available at SSRN 2408396.
- Foley, S., Karlsen, J. R., & Putniņš, T. J. (2019). Sex, drugs, and bitcoin: How much illegal activity is financed through cryptocurrencies? *The Review of Financial Studies*, 32(5), 1798-1853.
- Franco, P. (2014). *Understanding Bitcoin: Cryptography, engineering and economics*: John Wiley & Sons.
- Grall-Bronnec, M., Sauvaget, A., Boutin, C., Bulteau, S., Jiménez-Murcia, S., Fernandez-Aranda, F., . . . Caillon, J. (2017). Excessive trading, a gambling disorder in its own right? A case study on a French disordered gamblers cohort. *Addictive behaviors*, 64, 340-348.
- Griffiths, M. (2018). Hot topics in gambling: Gambling blocking apps, loot boxes, and 'crypto-trading addiction'. *Online Gambling Lawyer*, 17(7), 9-11.

- Gültekin, Y., & Bulut, Y. (2016). Bitcoin ekonomisi: Bitcoin eko-sisteminden doğan yeni sektörler ve analizi. *Adnan Menderes Üniversitesi Sosyal Bilimler Enstitüsü Dergisi*, 3(3), 82-92.
- Independent Tükçe. (2021). <https://www.indyurk.com/node/418151/ekonomi%CC%87/t%C3%BCrkiyedeki-kripto-paray%C4%B1r%C4%B1mc%C4%B1-say%C4%B1s%C4%B1-almanyadan-fazla>. Retrieved from <https://www.indyurk.com/node/418151/ekonomi%CC%87/t%C3%BCrkiyedeki-kripto-paray%C4%B1r%C4%B1mc%C4%B1-say%C4%B1s%C4%B1-almanyadan-fazla>
- Jalali, M. F. M., & Heidari, H. (2020). Predicting changes in Bitcoin price using grey system theory. *Financial Innovation*, 6(1), 1-12.
- Kim, K., Ryu, E., Chon, M.-Y., Yeun, E.-J., Choi, S.-Y., Seo, J.-S., & Nam, B.-W. (2006). Internet addiction in Korean adolescents and its relation to depression and suicidal ideation: a questionnaire survey. *International journal of nursing studies*, 43(2), 185-192.
- Kwon, J. H. (2021). On the factors of Bitcoin's value at risk. *Financial Innovation*, 7(1), 1-31.
- Makarov, I., & Schoar, A. (2020). Trading and arbitrage in cryptocurrency markets. *Journal of Financial Economics*, 135(2), 293-319.
- Marković, H., Nikolac, N., Tripković, M., Haluga-Golubović, I., & Čustović, Z. (2012). Connection between addictive behavior and investing on the stock market in Croatia. *Alcoholism and psychiatry research: Journal on psychiatric research and addictions*, 48(2), 69-80.
- Menteş, N., Yolbaş, İ., & Bulut, M. Development and Verification of Problematic Cryptocurrency Trading Scale.
- Nakamoto, S. (2008). Bitcoin: A peer-to-peer electronic cash system. *Decentralized Business Review*, 21260.
- Nar, M. Ş. (2019). Arkaik toplumlardan günümüze değiş-tokuş ekonomisi ve örnek ülke uygulamaları. *Journal of Economy Culture and Society*(60), 207-225.
- Polanyi, K., & Buğra, A. (2013). *Büyük dönüşüm: çağımızın siyasal ve ekonomik kökenleri*: İletişim Yayınları.
- Postbank. (2018). *Every third German considers cryptocurrencies as an investment*. Retrieved from <https://www.postbank.de/unternehmen/medien/meldungen/2018/mai/jeder-dritte-deutsche-zieht-kryptowachrungen-als-geldanlage-in-betracht.html>
- Songur, M. (2019). Bitcoin piyasasında balonlar: genelleştirilmiş Eküs ADF Testi. *Anemon Muş Alparslan Üniversitesi Sosyal Bilimler Dergisi*, 7(6), 187-192.



- Sonkurt, H., & ALTINÖZ, A. (2021). Cryptocurrency investment: A safe venture or a new type of gambling? *Journal of Gambling Issues*, 47.
- Sonkurt, H. O., & Altınöz, A. E. (2021). Cryptocurrency investment: A safe venture or a new type of gambling? *Journal of Gambling Issues*(47).
- Steinmetz, F., von Meduna, M., Ante, L., & Fiedler, I. (2021). Ownership, uses and perceptions of cryptocurrency: Results from a population survey. *Technological Forecasting and Social Change*, 173, 121073.
- Tetik, N., & Ahmet, Ö. (2020). Ülkemiz Girişimcileri İçin Yeni Bir Yatırım Desteği Modeli: Initial Coin Offering (ICO). *Muhasebe ve Finans İncelemeleri Dergisi*, 3(1), 13-26.
- Wciom. (2019). *Cryptocurrencies: after the hype*.
- Whelan, K. (2013). How is bitcoin different from the dollar. *Forbes*. URL: <http://www.forbes.com/sites/karlwhelan>.
- Young, K. S. (1998). *Caught in the net: How to recognize the signs of internet addiction--and a winning strategy for recovery*: John Wiley & Sons.
- <https://coinmarketcap.com/> Date of Access: (01.02.2022)
- <https://coinmarketcap.com/tr/currencies/bitcoin/> Date of Access: 02/02/2022
- Paper money, a Chinese invention? — Museum of the National Bank of Belgium (nbbmuseum.be) URL: <http://www.nbbmuseum.be/en/2007/09/chinese-invention.htm> (01.02.2022)
- What Is the Gold Standard? Advantages, Alternatives, and History (investopedia.com) URL: <https://www.investopedia.com/ask/answers/09/gold-standard.asp>(01.02.2022)



“

## Chapter 17

**IN SEARCH OF GRACE PALEY:  
INTERVIEWS AND STORIES**

*Sultan KOMUT BAKINÇ<sup>1</sup>*

”

---

<sup>1</sup> Assistant Professor, Haliç University, [sultankomut@halic.edu.tr](mailto:sultankomut@halic.edu.tr)

ORCID ID: 0000-0001-7815-389X

## Introduction

*“All of art is political; if a writer says this is not political, it’s probably the most political thing that he could be doing. That’s a statement of an alienation problem. I would say that my interest in ordinary life and how people live is a very political one. That’s politics; that’s what it is”* (Marchant et al., 1985, 610).

Grace Paley (1922-2007) was an author, a poet, an activist, a mother, a feminist, and a professor. As a representative of the 20th century American Literature, Paley used literature to describe societal developments and to paint a complete picture of modern life. Like most of her contemporaries, Paley’s fiction is characterized by self-reversal, that is to say, she created works delving into her own mind and identities. Thus, Paley’s fiction was directly related to her own experiences as a mother, a New Yorker, a Jewish, and an activist. Grace Paley was also a poet. She published her collections of poetry in her books *Leaning Forward* (1985) and *New and Collected Poems* (1992), *Long Walks and Intimate Talks* (1991), which included both poetry and prose writing, and finally *Begin Again: Collected Poems* (2001), which, as the title suggests, includes several poems written throughout her career. In 2008, *Fidelity*, another poetry collection, was published posthumously. As an author who started as a poet, Paley once said, “poetry was a way of speaking to the world, but fiction was a way to get the world to speak to me” (Conway et al., 1978, p.34). In other words, poetry was a tool for her to express her inner self and thus, reach the world. Yet, it was her fiction that established her literary fame.

Although Paley shared several concerns and thematic resemblance with her contemporaries, her entrance into American Literature is believed to be a “radical intervention in the stream of American Literature of mid and late twentieth century” (Chametzky, 2008, p.460). She published her first short story collection, *The Little Disturbances of Man*, in 1959. Then came *Enormous Changes at the Last Minute* (1974) and *Later the Same Day* (1985). A selection of stories in these three books was finally compiled as *The Collected Stories* (1994) and was a finalist for the National Book Award for Fiction and Pulitzer Prize. Paley also wrote an essay collection, *Just As I Thought*, published in 1999. The setting of her stories is mostly New York, with its daycare centers, schools, parks, public buildings, libraries, wide, shiny avenues, and gloomy, narrow streets. Paley considered herself “a regional writer”; she writes “I’m an urban writer with a New York focus” (Conway et al., 1978, p.37). In this regard, her stories reveal New York life, shedding light on the struggles of individuals, in particular women, by portraying mundane experiences of them without romanticizing. In these accurate portrayals, she created the stories of ordinary people dealing with the current problems of the society.

Therefore, this article aims to explore Paley's realistic representations of ordinary people in her fiction, in particular, women struggling to survive in a patriarchal society which not only denies their basic rights and necessities but also marginalizes them. In this vein, using various interviews that reveal Paley's versatile personality and her main concerns related to American society, this article draws parallels with the author's life and her stories from her short story collection, *Enormous Changes at the Last Minute* (1974).

Ellen G. Friedman and Miriam Fuchs contend that "women experimental writers not only assail the social structure but also produce an alternate fictional space, a space in which the feminine, marginalized in traditional fiction and patriarchal culture, can be expressed" (quoted in Darcy L. Brandel, 2010, p. 82). Likewise, as a political activist and feminist, Paley was not a conventional author; neither was her writing style. In an interview, when she is asked about her favorite story, she answers bluntly: "Well, if somebody says to me, 'What's wrong with this story?' — that's my favorite story" (Conway et al., 1978, p.39). One can infer that her "rupturing of traditional forms becomes a political act, and the feminine narrative resulting from such rupture is allied with the feminist project" as Friedman and Fuchs define the fiction of women experimental writers (quoted in Darcy L. Brandel, 2010, p. 82). One of her contemporary authors Philip Roth claimed that her language has "backhanded grace and irony all its own" (1961). Her stories can also be examined as representatives of postmodernism due to being mostly open-ended, not having a linear plot structure or a developed characterization process, incorporating varied tenses, and changing points of view and shifts between narrative voices. In her writing, one can find collages, ellipses, and fragments. Paley believes that "you should begin the story where the story begins, not two pages before with a lot of introduction and stuff like that" (Satz and Paley, 1987, p.487). Paley's stories do not generally include detailed descriptions of characters or settings, which she considers "irrelevant" (Satz and Paley, 1987, p.487). By using a lively language suited to the hectic life of New York, Paley made her unforgettable characters become as New Yorkers as possible with the local words, idioms, and slang. These factors contributed to constructing and developing a unique style that challenges the traditional form and content.

To unearth the sources of her main themes and their relevance to the author's life, it is convenient to analyze the characters she created throughout her life and her interviews about her writing. It is a well-known fact that in addition to the family, friendship, marriage, and children as her main themes, Paley wrote about women resembling herself. Like Paley,

her characters are “political activists who speak on nuclear energy, on the environment, and on all conditions that affect the world into which their children are born” (Mambrol, 2020). Paley’s life, as a whole, was an excellent basis for her fiction seeing as the figures in her life, in particular, her family members and their lives, were sources of her inspiration. In one of her interviews, she summarizes the highlights of her life:

I brought up the youngest (by about fifteen years) in an immigrant family that came from Russia. The languages at home, which were probably very powerful in my ear, were Russian and some Yiddish - not a lot, but some - mostly Russian and some Yiddish and English. And my parents’ English was good, and my grandmother’s English never came to anything, and so those languages were used a lot, mostly because of my grandmother, I guess. I guess you might say that my brother and sister were children of the working class, and I was a child of the middle class, some time later. I was very well treated and well loved by my family as the youngest person. (Aarons and Paley, 1993, p.50)

Three important keywords are worth considering here: her Russian background, her Jewish heritage, and her family’s role since these three set the basis of her art and life. As Victoria Aarons puts it, “Her fiction reminds us time and time again that one cannot, either by choice or necessity, escape history, those shared traditions, and events that have, even inadvertently, shaped one’s sense of self” (Aarons, 1990, p.27). In her stories, the characters are portrayed as interested and informed about political issues and they involve these matters in their daily conversations with others. For instance, in “Faith in the Afternoon”, the narrator reveals that “Severed Jerusalem; the Second World War still occupies their arguments; peaceful uses of atomic energy (is it necessary altogether?); new little waves of anti-Semitism lap the quiet beaches of their accomplishment” (Paley, 1987, pp.33-4). Paley’s background and political interests, as can be seen, are visible in her stories. The characters in her stories are inherently political, showing Paley’s concern about and awareness of the issues. As a member of an anti-zionist Jewish family that chose not to move to Palestine, unlike most of their relatives, Paley grew up in an atmosphere where politics was a common theme of conversation. She said that her parents were anti-Zionists like most socialists and believed that their “relatives had made the wrong decision and they had made the right one” (Satz and Paley, 1987, p.479). As an activist, Paley fought against the occupation of Gaza, too.

Faith Darwin, her most famous character, can be an example of the presence of her political interests in her fiction because, through Faith, Paley presents the story of an immigrant family that has left their homeland to find a better life in which they are not restricted and oppressed. Having

been forced to leave their origins, this family is composed of members who have been deeply hurt as the narrator unfolds in “Faith in the Afternoon”: “The Darwins moved to Coney Island for the air. There was not enough air in Yorkville, where the grandmother had been planted among German Nazis and Irish bums by Faith’s grandfather, who soon departed alone in blue pajamas, for death” (Paley, 1987, p.33). The family must leave everything behind and assume a new identity to be accepted in the new society they enter. This false identity might be the reason for their struggles since what they create becomes a substitute for themselves; they sacrifice the only thing that matters: the authentic self. As the narrator reveals, Faith’s “grandmother pretended she was German in just the same way that Faith pretends she is an American” (Paley, 1987, p.33). This pretension causes her to experience a double identity and makes her life an arena of struggle. As the narrator unfolds: “Faith really is an American and she was raised up like everyone else to the true assumption of happiness” (Paley, 1987, p.33). The assumption of happiness is a phrase that is worth commenting on. Being Jewish, Faith and her family’s life is full of dark experiences; she has been brought up in America, a land in which people are made to believe that their life is full of opportunities and that if one works enough, wants enough, and behaves accordingly, he/she will succeed. Unfortunately, this American Dream that was once possible has faded and most dreams remain unrealized. Faith is represented as one of those whose dreams do not come true. Through Faith and many other women characters, Grace Paley portrays these unfulfilled promises of American society.

Paley’s activism was not directed to one cause; she was “a combative pacifist and a cooperative anarchist”, a feminist, and many more (Gross, 2008, p.447). Holmes argues that Paley “proved herself to be a cornucopia of pamphlets, reports, articles, and conference speeches as a political activist in the anti-war, anti-nuclear, and women’s liberation movements” (2020). She became a fervent supporter of the women’s rights movement, attending conferences such as “National Women’s Year Conference” and playing significant roles in both organizations and foundations of groups such as Women’s Pentagon Action, Women and Life on Earth (1979), and Jewish Women’s Committee to End the Occupation of the West Bank and Gaza (1987). Her activism is also visible throughout her stories, poems, and essays. Though she has been criticized for “infusing too much politics” in her writing, it is a way of life for Paley (Bagnari, 1993, p.66). For her, politics could not be separated from daily life, which is a recurring theme of her works.

PALEY: To me, these things are all connected, very powerfully, and I would say that feminism is strongly connected to my anti-militarism.

As far as writing was concerned, I wrote mostly about women — that's where my deepest thoughts went. My early politics was all municipal; I mean, it was really related to my life, like the schools where my kids were, the street, the parks, the city in general. Then, by the beginning of the Sixties, it moved into a lot of anti-war work. I was stuck with all those things; I do less municipal work, and I miss it a lot because that's the street, that's where the life is, and I'm lonesome for that. (Marchant et al., 1985, p. 610).

It should be emphasized that Paley's activism did not retain her from writing. It can even be claimed that one always nourished the other. Paley mentions that writing and activism have similarities: "They both pay attention to human life and need to talk about it, and invent the best kind of communication" (Paley and Gardner, 1994, p.19). Through this line of communication, she created all her life, Paley could direct attention to what truly matters. It can be argued that one of the primary goals of Paley's writings is to highlight societal inequalities and difficulties, which is a critical function of Paley's work. In her interview with Harriet Korim (2008), she comments on her political work, saying that "it is more serious than my writing" (p.566). As a result, her activism is felt in many stories where the characters voice the problems inherent in the system and think about the world's matters. In the following example, the unnamed narrator is divorced, and her ex-husband accuses her of not wanting anything. As a response, the narrator says:

I felt extremely accused. Now, it's true, I'm short of requests and absolute requirements. But I do want something.

I want to be the effective citizen who changes the school system and addresses the Board of Estimate on the troubles of this dear urban center.

I *had* promised my children to end the war before they grew up. (Paley, 1987, p.5)

The use of italics in "*had* promised" shows the readers that this wish could not have been realized. In another example, the readers see how women raise their consciousness in political matters and act as activists in Paley's fiction. In "Distance", even though the narrator seems to be pessimistic about the result of the act and, for that reason, does not involve in the activism, she talks about others:

Five ladies on the block, old friends, nosy, me not included, got up a meeting and wrote a petition to Child Welfare. I already knew it was useless, as the requirement is more than dirt, drunkenness, and a little once-in-a-while whoring. That is probably something why the children in our city are in such a state. I've noticed it for years, though it's not my business. (Paley, 1987, p.16)



The narrator's drawback does not demonstrate her lack of interest; on the contrary, it shows that she is well aware and has been tired of the unresolved problems. Through this character, one may confer that, Paley directs attention to the flaws of the system.

Paley openly says that neighborhood determined her subject matter (Marchant et al., 1985, p. 614). As an author who directly expresses her influences, Paley includes her heritage in her fiction by creating characters who speak articulately about the diaspora. Similarly, Wolfe (2008) defines her characters as "urban, urbane, free-spirited, tough, most of them were Jewish, were exotic birds" (p. 499). However, they are hardly self-contained; and are rarely defined apart from their communities, links, and responsibilities to others (Aarons, 1990, p.20). As a result, these characters constantly interact, sharing what is essential in their ordinary lives, caring, protecting, defending, supporting, and most importantly, talking.

Using information gleaned from observation of events and her personal experience, Paley painted accurate portraits of American society. In her article that focuses on Grace Paley's anti-war writing, Marianne Hirsch states, "in her protest and direct action, in her writing, Paley practiced an embodied politics and an aesthetics of interruption and disruption, and of surprise" (Hirsch, 2009, p.1769). Paley created characters of diverse ethnicity and various backgrounds, compatible with the country, particularly with the neighborhood she lived in and wrote about. As a leftist political figure who believed in equality, she portrayed the lives of minorities who were outcasts in daily life. For instance, in "Faith in the Afternoon", through a dialogue between Faith and Mrs. Hegel-Shtein, stereotyping that exists in the society is made visible. As the surname makes it clear, Mrs. Hegel-Shtein is a German American, a representative of one minority in New York. However, notwithstanding her position, she openly stereotypes Spanish people: "The men don't like their wives so much. They only get married if it's a good idea" (Paley, 1987, p.44). By including such characters as Hegel-Stein, who puts barriers between different ethnic groups who supposedly coexist in harmony, Paley holds a mirror to the society, in which people deepen the conflicts that are already present and are bound to exist.

As the mother of two children, Nora and Danny, it was not unusual for Paley to include motherhood as a theme in her works. What is more, motherhood, in Anna Bagnari's words, was her "great theme" (1993, p.66), and thus one can find many references to motherhood in her prose, fiction, and interviews. In these, the significance of motherhood and the effects of being a mother are evident. In addition, she often commented on how her own motherhood and her writing were hand in hand. For instance,

in one of the interviews, Paley informs us how she handled her children along with her writing and activism. She says:

And as a poet, even when the kids were around, I always had hunks of paper in my back pocket, when I was in the park or wherever, so I was always writing. But when I sat down to write the stories, it so happened that I had been sick before that, and the kids were in day-care — don't know what I would have done without that day-care center — in that period I was able to begin this very hard task of working in another form. I didn't have months ahead of me, but I did have whole days for several weeks. I don't like that "in spite of the children." Life is what you live, and you do everything you can in it, you know, if you're normally greedy. There's hardly any of these things that I would've wanted to do without — the writing or the children. Maybe I had the children in spite of the writing, or the writing in spite of the children, or the politics in spite of the two of them (Marchant et al., 1985, p. 608).

Life without her children might have been easier; yet, whether her career as an author would have been better without them is not certain, seeing as Paley enriched her writing with everything related to motherhood. Many scholars wrote about the connection between Paley's fiction and her private life. For instance, Bagnari contends that Paley included her experiences, her motherhood, and the motherhood of her friends in her fiction; thus, the theme of motherhood "is tied to her biography" (Bagnari, 1993, p.66). Making motherhood as a great theme in her fiction, Paley did not only reveal her experiences but also the problems other mothers suffer from in a patriarchal society, which is a political act.

For Grace Paley, "the natural function of literature is to illuminate what has not been seen" (Paley and Gardner, 1994, p.19), and as a result, her works disclose what is not visible. That does not mean that her stories are full of mysteries or dark realities of life which are hidden from the general public. On the contrary, these are the realities that are mostly dismissed, ignored, or believed not to have any merit to be portrayed. The presence of such matters can be explained through Paley's reliance on ordinary life in fiction. In one of her interviews, she writes, "Ordinary, everyday life is what seemed to me almost the most mysterious" (Michaels and Paley, 1980, p.4). Her easily identifiable characters are from daily life with all their simplicity and complexity. She always mentioned how authentic her characters were, how she hung out with them, sat in the child parks together, and talked about their kids, husbands, and everything else, including politics. In Faye S. Wolfe's words, "the women are bound together through talking, through political activity and the raising of their children" (2008, p. 502). In that regard, they do not experience motherhood as a private matter, "they share it with other mothers" (Bagnari, 1993,

p.72). Although these women return to their homes with their children, on the streets, or in the playground, they try to overcome the challenges of life together. One can talk about a collective mothering in which women happen to find happiness and strength in sharing the burden of the daily life of a mother. This burden, undoubtedly, is unfolded by the women characters who become examples of the fact that motherhood is a political issue. Accordingly, Bagnari believes that Paley's characters are "feminists by instincts: their witty, resilient voices are their powerful weapon of defense and offence" (Bagnari, 1993, p.70).

One of the traits of Paley's fiction is that she revisits the lives of the same women characters in different stories. The most important and well-known of these characters are undoubtedly Faith and Grace. Faith Darwin, in particular, is claimed to be the author's alter-ego even though she has made it clear in many interviews that she is not. In an interview in 1978, when she is asked whether she identifies with Faith or not, she answers, "Not really. I didn't lead that kind of life. She was that woman with two husbands who didn't like eggs (*The Used Boy Raisers*), and that wasn't me. That was a good friend of mine. I identify with some of her attitudes, and the times we spent together in Washington Square Park. She was one of many women who interested me in the mid-fifties" (Conway et al., 1978, p.31). In years, her identification and description of Faith evolved, too. In another interview, conducted nine years later, she claims that Faith "could've been a friend, but she wasn't" (Satz and Paley, 1987, p.488). This comment asserts that contrary to many assumptions about Faith's being her alter-ego, she is one of many characters to which the author gave life.

Nevertheless, as a result of including her and her sons so many times for so long, she feels that she is like an acquaintance. Paley reveals that by saying: "I know her well, but she has this funny mixture of some times taking over one of my parents and then not" (Satz and Paley, 1987, p.488). Furthermore, Paley discloses that she has given this name as a joke while "playing around" (Satz and Paley, 1987, p.488), which also distances Faith from herself. However, like most authors, she is inspired by the people around her while creating her characters. Regarding Faith, she further asserts that:

And certain other characteristics are not mine. And the father is not like my father. But what he has is my father's energy and his gift for storytelling. But the mother is really just not good. She's not like my mother or anybody else's mother. I feel that Faith is further away from me than she might be, and I'm glad of it. I'm glad of it. (Satz and Paley, 1987, p.488).

The examples used in this paper show that most of Paley's protagonists and minor characters are women. In the post-war era in American society, it

is impossible not to notice how “women find themselves in a hostile, even indifferent patriarchal world to which they are unable to adjust” (Baksi Yalcin, 2020, pp. 66-67). As a feminist, Paley was aware of the realities of this patriarchal society. As a result, she was very much involved in the feminist movement and other political activities. While she acknowledges the oppression women experience, she does not define them as “victims”; instead, she argues that most women struggle, resist, and they are “very strong” (Conway et al., 1978, p.31). Consequently, in her stories, women are not portrayed as victims; they are, in the streets, fighting for their rights, raising other people’s consciousness, and fighting against the patriarchal society. In Gloria L. Cronin’s words, the women in Paley’s fiction “demythologize romantic love, protest a destructive world order, deconstruct the patriarchal history, and talk themselves into unquenchable being” (Cronin, 1992, p.149). However, these women are not glorified or praised for having these traits. In different interviews, Paley mentioned having mostly women characters in her stories, women with their unique worlds filled with ordinary details, as she believed that men had told enough of their stories. In her interview with Satz, she says, “Unless we [women] tell about our lives, those stories can’t be listened to. You can’t bear half the truth” (Satz and Paley, 1987, p.485). Hence, Paley’s stories are predominantly full of women characters who are representatives of millions of women in the streets, dealing with life as it is. Unfortunately, they are not always successful. Still and all, they are, in Wolfe’s words, “all the more heroic in their failures” (Wolfe, 2008, p.502). Be that as it may, they do not show any resemblance with heroes looking for great victories, vengeance to take, or having fascinating adventures to catch the readers’ attention. These women just work, take care of their houses, look after their children, meet with their friends in parks, make tea in the kitchens and share their problems, frustrations, secrets, and recipes. Thanks to their social network, they are not isolated from society and do not sit at home all day and be depressed: they go out, protest, vote, read, speak, and live. She wrote “the story of women whose stories have been untold” (Satz and Paley, 1987, p.480). Even though literary works have been telling the stories of women who are in agony, suffering, or victimized in one way or another, Paley’s characters are somewhat ordinary and pretty familiar, and thus they are more realistic.

These women in her stories do not stand on the sidelines when children’s welfare is concerned. For instance, in “Faith in a Tree”, women talk about issues that matter to society, such as money shortages in the public schools, what the Board of Education should do to integrate public and private schools, and the parent-teacher associations (Paley, 1987, p.89). In “Distance”, for instance, women get together and write a petition

to Child Welfare to protect the children from their mother, Ginny, who is in emotional distress, hence, is dirty and negligent. In the story, the narrator does not take part in writing the petition since she understands the fundamental problems underlying the mother's emotional problems. Nonetheless, the narrator is also aware that Child Welfare ignores the petitions; it "does not show its concern" (Paley, 1987, p.16). Through details like this, Paley criticizes the existing governmental institutions that do not operate well only to leave the needs of the citizens unrealized.

The women in Paley's stories believe that it is their responsibility to take care of the children no matter how old they are, believing that they always have a right to interfere, like Dolly in "Distance," who believes that Ginny is not a suitable partner for her son. During a confrontation with Ginny, Dolly makes it clear by saying: "MY SON IS MY BUSINESS. BY LOVE AND DUTY" (Paley, 1987, p.22). As Dolly makes it clear it is not only their love for their children; these women have responsibilities towards them, knowing that nobody would support them if they, as mothers, were not there for their children. In Paley's world, the mother takes full responsibility for the children when the father is almost always ignorant or away from the family. Consequently, the mothers' priority is on the children rather than themselves. In "Faith in the Afternoon", Faith's mother reveals this very clearly: "Who comes first? The children . . . the little children, they come first" (Paley, 1987, p.37). Since these mothers are sure that the fathers of their children do not and will not take responsibility, even when they are physically hurt or have terminal diseases, they are more concerned about their children's future than their own. In "Living," Ellen can be an example of this situation. In the story, while two friends, Faith and Ellen, talk about how they are dying, metaphorically and literally, all they care about is their children. Ellen reveals her anxiety by saying: "Faith, what'll we do? About the kids. Who'll take care of them? I'm too scared to think" (Paley, 1987, p.60). When she finally dies, Faith is anxious about her friend's son, yet the boy says "Don't worry Faith, my mother made sure of everything. She took care of me from her job. The man came and said so" (Paley, 1987, p.61). He says he will start living in another city with his uncle. Throughout the story, the father of the child is not mentioned. He might be dead or an ignorant father; thus, Ellen is a single mother who cares for her child when she is alive and thinks about her son's future on her deathbed.

Paley's short fiction bears feminine modalities of productive speech anchored in a mother's subjectivity that converts child-rearing responsibilities into a moral action (Chaskes, 2013, p.142). However, this moral action is performed mainly by female characters since, in Paley's stories, fathers are almost always absent and distant in the children's lives.

The mothers take care of the children, raise them, teach and help them, yet they cannot fill the shoes of a father figure. In "Faith in a Tree", when a man, Phillip, takes her son Richard to communicate with another kid at the park, Faith cannot help blaming herself: "Richard and Phillip were holding hands, which made Richard look like a little boy with a daddy. I could cry when I think that I always treat Richard as though he's about forty-seven" (Paley, 1987, p.94). Although she tries to fulfill the roles of both parents all by herself, as a single mother, she cannot. The feeling of being dependent on a man is revealed when we read: "You're an American child. Free. Independent. Now what does that mean? I have always required a man to be dependent on, even when it appeared that I had one already. I own two small boys whose dependence on me takes up my lumpen time and my bourgeois feelings" (Paley, 1987, p.80). She is not blind to her own reality and feels sorry for her child. Therefore, one can infer that it is not women's choice to raise these children alone; yet, when they are left without options, they put their heart and soul into raising their children well. By accurately portraying these motherly concerns and adding her own criticism in an effort to motivate others to improve their lives, Paley painted a realistic representation of the challenges of motherhood.

## Conclusion

The writers of the 20th century utilized literature to describe societal developments and to paint a complete picture of contemporary life. Paley was one of them. In this article, it is claimed that Paley never held herself back from the harsh realities of life. She wrote realistically about motherhood, friendship, the failure of American society, and many more issues with great simplicity and complexity at the same time. As an author who portrayed ordinary people in their daily lives, she criticized governments, institutions, and the social ills of society, which is a key characteristic of her fiction. It is also shown that through these ordinary characters who resemble Paley in terms of being an activist, caring the society and criticizing the wrongdoings of the authorities, Paley called attention to the flaws of the system and portrayed how American dream become unrealized for most people, especially women. Being a feminist, Paley became the spokesperson for the ordinary women who were rarely represented in literature. Even though most characters were oppressed, and repressed under the patriarchal society, her characters were not portrayed as victims that are crushed under the system; instead, they were out in the street fighting for their rights, writing petitions, creating a community for themselves by sharing the most ignored, daily life of women. Hence, it is argued in this paper that the women in Paley's fiction are not victimized or heroized, they are portrayed in their daily struggles

of being a mother. Additionally, it is stated that these women are not alone in their struggles; they are always accompanied by other women who share the similar concerns about their children, which can be viewed as collective motherhood. By making use of Paley's interviews and taking the stories from *Enormous Changes at the Last Minute* as a backdrop for her fiction, this study concludes that the display of women's struggles in Paley's fiction contributes to a better understanding of the ordinary women who are ignored in respect of their basic rights and necessities in the middle of the 20th century, thereby providing a ground for her political views as an activist.

## WORKS CITED

- Aarons, V. (1990). Talking Lives: Storytelling and Renewal in Grace Paley's Short Fiction. *Studies in American Jewish Literature* (1981-), 9(1), 20–35. <http://www.jstor.org/stable/41205739>
- Aarons, V., & Paley, G. (1993). “The Tune of the language”: An Interview with Grace Paley. *Studies in American Jewish Literature* (1981-), 12, 50–61. <http://www.jstor.org/stable/41206177>
- Bagnari, A. “A Definition of the New Woman Through Motherhood in Grace Paley's Short Stories”, *REN*, no. 2, Sep. 2019.
- Bakşı Yalçın, O. “The Silent Discontent in Shirley Jackson: *The Lottery and Other Stories*” *Silence and Silencing in the American Context*. Eds. Olgahan Bakşı Yalçın, Sultan Komut Bakıncı. Ankara: Nobel Akademik Yayıncılık, Aralık 2020.
- Brandel, D. L. (2010). Performing Invisibility: Dialogue as Activism in Grace Paley's Texts. *Frontiers: A Journal of Women Studies*, 31(2), 77–102. <https://doi.org/10.5250/fronjwomestud.31.2.77>
- Chametzky, J. (2008). Grace Paley. *The Massachusetts Review*, 49(4), 460–460. <http://www.jstor.org/stable/25651819>
- Chaskes, D. (2013). “Shout It Out Loud”: Grace Paley and the Radicalization of Maternity. *Journal of Modern Literature*, 36(2), 140–155. <https://doi.org/10.2979/jmodelite.36.2.140>
- Cronin, G. L. (1992). Melodramas of Beset Womanhood: Resistance, Subversion, and Survival in the Fiction of Grace Paley. *Studies in American Jewish Literature* (1981-), 11(2), 140–149. <http://www.jstor.org/stable/41205821>
- Conway, C., Innes-Brown, E., Levine, L., Monley, K., Teich, M., & Paley, G. (1978). Grace Paley Interview. *Columbia: A Journal of Literature and Art*, 2, 29–39. <http://www.jstor.org/stable/41806739>
- Hirsch, M. (2009). “What We Need Right Now Is to Imagine the Real”: Grace Paley Writing against War. *PMLA*, 124(5), 1768–1777.
- Holmes, A. (2020, March 31). *Women's History: Grace Paley's Family Tree*. Library of Congress. <https://blogs.loc.gov/catbird/2020/03/womens-history-grace-paleys-family-tree/>
- Korim, H., & Paley, G. (2008). Selections from an Interview by Harriet Korim for Back Pages. *The Massachusetts Review*, 49(4), 566–569. <http://www.jstor.org/stable/25651844>
- Mambrol, N. (2020, June 22) Analysis of Grace Paley's Stories. *Literariness*. <https://literariness.org/2020/06/22/analysis-of-grace-paleys-stories/>



- Marchant, P., Ingersoll, E., Paley, G., & Harris, R. R. (1985). A Conversation with Grace Paley. *The Massachusetts Review*, 26(4), 606–614. <http://www.jstor.org/stable/25089703>
- Michaels, L., & Paley, G. (1980). Conversation with Grace Paley. *The Threepenny Review*, 3, 4–6. <http://www.jstor.org/stable/4382967>
- Paley, G. (1987). *Enormous Changes at the Last Minute*. Farrar, Straus and Giroux.
- Paley, G., & Gardner, J. (1994). An Interview by Joann Gardner. *The American Poetry Review*, 23(2), 19–24. <http://www.jstor.org/stable/27781440>
- Paley, G., & Gross, T. (2008). Interview by Terry Gross. *The Massachusetts Review*, 49(4), 445–449. <http://www.jstor.org/stable/25651814>
- Roth, P. (1961, March). Writing American Fiction. *Commentary* <https://www.commentary.org/articles/philip-roth/writing-american-fiction/>
- Satz, M., & Paley, G. (1987). Looking at Disparities: An Interview with Grace Paley. *Southwest Review*, 72(4), 478–489. <http://www.jstor.org/stable/43469964>
- Wolfe, F. S. (2008). Grace Paley's stories. *The Massachusetts Review*, 49(4), 499–503.



“

## Chapter 18

**THE USE OF SHORT STORIES IN  
LANGUAGE CLASSES: A SAMPLE  
ANALYSIS**

*Semra SARAÇOĞLU<sup>1</sup>*

”

---

<sup>1</sup> Assoc. Prof. Dr. Semra Saraçođlu, Gazi University, Gazi Education Faculty,  
Department of Foreign Languages, English Teaching Programme

Orc Id: 0000 0001 8331 7705

## **Introduction**

### **1.1. The place of literature in language classes**

There has always been a debate on the place of literature in language teaching classes. The use of literary texts in language teaching provides various benefits to learners. It is argued that literature gives students opportunities to improve their language awareness, contributes to their language skills in reading, writing, listening and speaking and enlarges their vocabulary repertoire. Since it offers real-life like and authentic contexts, literature presents students new worlds expressed in very many different syntactic patterns and structures. The wide range of genres and different themes also enable students learn verbal/non-verbal aspects of communication leading to their both cultural and communicative competence. Apart from the abundant alternative lexical usages that literature offers to learners, it improves their historical, social, and political knowledge about the culture of the target language. It increases their motivation, imagination and interest while at the same time contributing to their personal growth and affective engagement. It also facilitates their acquisition of diverse point of views developing their critical thinking abilities. While reading such texts, students learn being tolerant to the others and build an awareness not only for themselves but also for the others. In the transactional experience that they have with the text, the world of the text and that of the student intersect somehow and student becomes the vital participant in the reading process and as a result becomes autonomous in meaning construction.

### **1.2. Methodology in reading a literary text**

Brown (2001) uses two terms for main processes in reading methodology: bottom-up and top-down (p.78). In bottom-up processing, as Nuttall (1996) states, readers create a meaning working out sentence structure focusing on the linguistic signals. On the other hand, in the top-down processing, reader brings his/her past real life experience as well as his/her past reading experience. H.L.B. Moody provides a method for understanding the meaning of a literary text. Moody emphasizes the importance of both the extrinsic features - historical, social, political and the literary background of the period the writer lived, and the intrinsic features – the grammatical, lexical structure of the text- in understanding the meaning of a text (in Brumfit, 1983, pp.23-25).

Robert Scholes, on the other hand, in his work *Textual Power* (1985) explains his approach for reading a literary text. He remarks that there are three aspects in reading a text; reading, interpreting and criticism. In Scholes' words, the texts are studied 'within', 'upon' and

'against' themselves to reconstruct new texts. When students read a text 'within', they study it in terms of linguistic and cultural features i.e. they grammatize the text. In the first step, they have a tendency to summarize what they read as a sign for how much they grasped the general meaning. The second step is reading 'upon' a text i.e. interpreting. In this stage, students study the metaphorical and symbolic dimensions of the text. They move one step further from 'grammatization' to the 'thematization' of the text and create their own texts synthesizing both the author's intention and their own experiences. The last step, reading 'against' a text, i.e. criticism, is not expected by ELT students since they don't have sufficient background to compare and contrast the text with the other fictional works in the canon (p.24). If the teacher provides literary texts considering the needs, interests, and language levels of the students, learners' motivation increases; generating new responses, they attain different point of views; achieve new reading strategies; have the chance to dive into the hidden meanings between the lines and learn how to think critical and creative. As readers, they start playing an essential role in the process of creation and can develop their textual competence i.e. their ability to read, interpret and criticize a text unconsciously by being imposed to several texts from different genres written in different periods by some distinctive writers.

### **1.3. The history of short story**

Short story is a brief fictional narrative in prose shorter than the short novel. The brevity of a short story differs from 500 words up to 12000 to 15000 words (Holman 1972:496). Yet, there are exceptions like "Richard Brautigan's 34-word 'Scarlati Tilt' and Joseph Conrad's 50000-word 'Heart of Darkness'" (Bozer, 1995, p. 84). A short story is usually concerned with not more than a few effects, problems or themes. Unlike the novel, short story does not develop the character fully. Generally, a single aspect of a character's personality undergoes a change or is revealed as a result of some incident, confrontation, or conflict. A short story writer usually concentrates on a single character involved in a single episode. Because of the spatial limitation, there are generally no detailed descriptions of background in a short story. Edgar Allan Poe 'formulated basic principles for the composition of short prose narratives' (Shaw, 1986, p.9). He especially emphasizes the three aspects of the short story: a short story should be read in one sitting; should contain no digressions-sub-plots; and should have one single effect.

The history of storytelling extends far back to a time long before the invention of the printing press. The first stories that are known are of the oral tradition such as myths, legends, fables, Biblical stories and fabliaux. In general, a myth is a story which is not 'true' and is created

by men to explain the supernatural phenomenon-relationships between men and supernatural beings, or gods. Legends, on the other hand, are stories or narratives about the lives of a particular figure or person. In the 6<sup>th</sup> century BC, we see the earliest examples of fables. The most famous ones are associated with Aesop, a Greek writer. The characters of a fable are non-human creatures or inanimate objects that are given human attributes and they almost always end with a moral stated overtly at the end. In the Bible, we may find stories about man's creation, the Fall of man from Heaven, or such as the accounts of Abel and Cain. Fabliau flourishes in France in the 13<sup>th</sup> century as the low life comic tales in verse. In the 14<sup>th</sup> century, the most notable writer of short prose tales was Italian Giovanni Boccaccio who wrote *Decameron* and his contemporary English Geoffrey Chaucer, the writer of *The Canterbury Tales*. *Decameron* is formed of a series of 100 tales told by seven ladies and three gentlemen who escaped from the plague. Chaucer's *The Canterbury Tales*, on the other hand, was written in verse as a satire consisting of both religious and secular tales told by pilgrims on their way to and from Canterbury. The aim is to criticize the different levels of the English society of his time. In this work, several different short fictional genres can also be found like romances, burlesques, religious parables or fabliaux. In the 15<sup>th</sup> century in England, Malory writes *Morte d'Arthur* as one of the first major work of prose fiction in English about the battles and victories of King Arthur and his Knights at the round table. Edmund Spenser writes *Faerie Queen* in the 16<sup>th</sup> century - an epic allegorical poem which dwells on the stories of the knights. In the 18<sup>th</sup> century, novel as a new genre evolves and with the rise of the novel, writers like Henry Fielding start including short stories in their novels. In *Tom Jones*, Fielding inserts a story- 'The Man of the Hill' within his novel. In the 18<sup>th</sup> and the 19<sup>th</sup> centuries, some romantic and Victorian poets write stories in their poems; for instance, Samuel Coleridge in *The Rime of the Ancient Mariner*, Alfred Tennyson *The Lady of Shallot*, Robert Browning *Pippa Passes*. In the early 20<sup>th</sup> century in England, Rudyard Kipling writes short stories about the sea, jungle, and the beasts. In America Washington Irving, under the influence of Grimm Brothers who wrote a collection of 'Childhood and Household Tales', creates the American version of European folktales. In his *Sketchbook*, the earliest examples of American short story, 'Rip Van Winkle' and 'The Legend of Sleepy Hollow' were published. Nathaniel Hawthorne too writes short stories such as 'Young Goodman Brown'. Yet, since they are mostly allegorical stories, his stories cannot be considered as modern short stories.

The modern short story starts with Edgar Allan Poe. Apart from his definition of the short stories focusing on the unity, brevity and singleness of effect, he introduces three types of short story. Firstly, the detective story such as *Murders in the Rue Morgue*, secondly the gothic spine chiller- *The Tell-Tale Heart*, and thirdly the science fiction short stories – *The Gold-Bug*. At the end of the 19<sup>th</sup> century, the French writer Guy de Maupassant and Anton Chekhov from Russia contributes a lot to modern short story by bringing remarkable innovations to the content and form of the short story. In Maupassant's short stories, plots are tightly organized and usually concluded with a decisive action. On the contrary, in Chekhov's stories, plots included less decisive action. The next generation, that is the experimentalists, were mainly influenced by Chekhov, developing his less sharply detailed impressionistic atmosphere in their works. The modernist writers in the early years of the 20<sup>th</sup> century challenge the conventions of the dominant literature and culture. They are Joseph Conrad, Virginia Woolf, James Joyce, D.H. Lawrence, and Katherine Mansfield. The American modernists were influenced both by Chekhov and Maupassant. Among them, the first names that come to mind can be stated as Sherwood Anderson, Katherine Anne Porter, William Faulkner and Ernest Hemingway. The modernists explore the concept of an interiorized plot. James Joyce's *Dubliners* which consists of fifteen short stories is one of the landmarks of this period. Rather than building his stories around a dramatic climax in the action, Joyce heightens the climactic movement of self-realization that he found in Chekhov's stories.

Literary critics distinguish between two types of short stories written today: Traditional short stories descending from Poe and Maupassant which are plotted and closed, and modern stories descending from Chekhov and Joyce which are less plotted and more open.

#### **1.4. The aim of the study**

Since short stories are brief fictional narratives in prose, and simpler in language in comparison with the language of poetry or shorter to read in the class in comparison to a novel, they are more practicable to be used in language classes. There is a single plot, limited number of characters and a single effect in short stories. Just like novels, drama and poetry, short stories too contribute to the language learning. They are motivating for student discussions and analysis, and advantageous in developing students' reading comprehension, writing, listening, speaking skills, enhancing their vocabulary repertoire as well as their creative writing abilities. The last but not the least of all, reading short stories contributes to their cultural development and personal growth. The aim of this chapter is to show how to study a short story in ELT classes in the light of deconstructive and

semiotic approaches to literary texts. D. H. Lawrence's short story 'The White Stocking' will be analysed employing both H.L.B. Moody's and Robert Scholes's theoretical principles.

## 2. Discussion

### 2.1. The Extrinsic features in Moody's Approach

Lawrence's works bear a lot of autobiographical traces. Therefore, it would be appropriate first to familiarize students with him as a person and a writer. He was born in the mining village of Eastwood, Nottinghamshire. He was the son of a drunken miner father and a better educated mother who came from a middle class family. The struggle between the parents were felt even by the children. In his early years, Lawrence was on the side of his mother against his father. The mother replaced her love for her husband with that of his children and fought for them to get a good education; struggled not to let them be miners like their father. His mother, especially after the death of his elder brother, was too much attached to Lawrence. She was suffocating him with her love and devotion. The mother's claims on him caused frustration in his future relationships with women. Lawrence won a scholarship to Nottingham High School and later worked as a clerk in Haywoods surgical goods factory; attended Nottingham University to get his teacher's certificate. Apart from Jessie Chambers, the Miriam of *Sons and Lovers* (1913), he fell in love with the German wife of a Professor of French at Nottingham. After Frieda got divorced to live with Lawrence, they went to Germany together and married in 1914. Lawrence and his wife travelled a lot together; went to Italy, Australia, Mexico and France. At the age of 44, he died of tuberculosis in France.

Lawrence is one of the leading modernist writers who is considered to be a rebel in his literary views. He is a novelist, a short story writer, a poet and a playwright. He also wrote essays, travel books, translations and letters. His first novel, *The White Peacock* was published in 1911 just after he lost his mother. It was not well received. *The Trespasser* (1912) is also one of his early novels. *Sons and Lovers* (1913), on the other hand, is his most autobiographical novel and was a success. Nevertheless, it is with *Rainbow* (1915), *Women in Love* (1920), and *Lady Chatterley's Lover* (1928), his originality emerges with his rebellious attitudes against the social, political, religious and mostly sexual morality of the nineteenth century. Lawrence was born into the nineteenth century England. After the Industrial Revolution, the mechanization of the society and the urbanization of the country corrupted nature. Corruption was everywhere, even the institution of religion was misinterpreted and changed into a cold and restrictive one. He was very much concerned



with relationships - the relationship between man and woman, the intellect and the instinct and the marriage relationship. In his book *Psychoanalysis and the Unconscious* (1928), he indicates that he admires the id while Freud finds the id as destructive. He appreciates the nature and the natural against the industrialization and the corrupt. He thinks that the primal source of life exists in the unconscious. Yet, he never ignores the power of the intellect since there should be a balance between the two for the ideal state of being.

## **2.2. The Intrinsic Features in Moody's Approach and Scholes's First Approach in Reading a Text: Reading 'within' a Text**

Having covered the extrinsic features which will be a guide in building the overall meaning of the story, especially for such a writer like Lawrence, as the next step the intrinsic features are focused on. In reading 'within', the aim is to check whether students understand the linguistic code of the story focusing on the grammar and the vocabulary; if they could have grasped the general meaning of the text. In the reading process, students are asked some questions covering the elements of literature such as plot, setting, narration and characterization. Bringing their own past experiences and past readings in accordance with their interaction with the text, sometimes selecting, limiting or foregrounding specific points, they summarize the story. Since this activity is done as a classroom discussion working in peers, they end up building the chain of the incidents i.e. the plot of the story.

'The White Stocking' is divided into three parts. The first part takes place in the present time. It starts in the bedroom of a newly married couple Ted and Elsie Whiston. It is a Valentine's Day. The postman brings some packages for Elsie. First, she tears the thin envelope and sees a Valentine's card; then opens up a white cardboard box and finds a white silk handkerchief with her initials worked on it. In the last envelope, she discovers a long white stocking, in which a pair of pearl earrings have been put. She immediately goes to the mirror having worn the earrings and watches herself taking great pleasure in seeing them dangling under her ears. There is also a note in the box saying, 'Pearls may be fair, but thou art fairer/Wear these for me, and I'll love the wearer.' (Lawrence, 1977, p. 246). Elsie conceals the earrings from Ted. She just shows him the silk handkerchief her initial worked in the heliotrope embroidery, the cartoon and the white stocking which Elsie tells him, sent as a sample. Ted doesn't approve of her receiving gifts from others for Valentines as a married woman and gets displeased. Elsie pretends that she doesn't know who the sender is but can only guess. She suspects that it could be Sam Adams. Ted sees the poesy written for Elsie - "Pearls may be fair, but thou art fairer / Wear 'these' for me, and I'll love the wearer" (Lawrence,

1977, p. 246). Since there is only one stocking and no pearls and the pearl earrings have been hidden from him, the note sounds completely meaningless for him. Concealing the earrings, she explains the note implying that it was for the stockings which makes a pair with the one sent last year. Ted gets both angry and jealous. He slips the paper into a ball and flings it to the fire. He wonders whether she has been seeing him and learns that she met him in the Royal to have coffee. He gets angrier and bitter; insults his wife saying, 'You'd go off with a nigger for a pocket of chocolate' (Lawrence, 1977, p. 249). She is hurt. Whiston gives her a kiss that morning too as he used to do. Elsie doesn't forgive him. Yet, in a moment, after his departure, her mood changes. She goes upstairs to wear the earrings. While Whiston spends the day anxious, she postures in front of the mirror, feeling happy and stimulated the whole day.

The second part is a flashback. Two years ago, Elsie was invited to a Christmas party that Sam Adams held and attended the party accompanied by Ted. Whiston was courting her then. Adams invites Elsie to dance. Since Ted does not dance, but plays cribbage; Adams dances with her three times which she found 'delicious' and 'so gratifying irrespective of man' (Lawrence, 1977, p. 253). In the last dance, Elsie was so much impressed that she 'almost lost to her own control' (Lawrence, 1977, p. 257). When she reached for her pocket handkerchief, it fell from her hand and she realized that she took a white stocking instead of a handkerchief to her surprise. Adams kept it as memory. Ted, who witnessed the scene, learned what she dropped and warned Elsie not to allow him to keep it. They left the party. She was very sorry and found compassion in Ted's arms.

The last part is a return to the present. Elsie is told to have left her job at Adams' soon. In a few weeks, she married Ted Whiston. After some months, as a newly married woman, Elsie met Sam Adams. When Valentine's came, near their first anniversary, Adams sent her a white stocking with a little amethyst brooch. She kept it as her possession not mentioning about it to her husband. And now she has the pearl earrings. She kept them as well and thought of pretending that she had inherited them from her grandmother. When Whiston returns from work, he asks Elsie what she did with the stocking. She tells him that she has put it in the drawer to make a pair with the one sent a year before. Unable to move him, she goes upstairs, puts them on and starts dancing in front of him, lifting her skirt to her knees and kicking her legs up at him. He gets angry; becomes abusive. Elsie doesn't stop and rejects doing what he tells her to do, instead goes further on telling about the other presents sent by Adams. Ted goes wild; cannot control his anger and slaps her on the face. He is overcome with weariness and sits heavily; watches her piteously while she is crying. Then he packs all the jewellery up and

sends it back to Adams. Returning to the sight of his wife's 'tear-stained, swollen face', he is moved. She is sorry and Whiston again consoles her in his arms.

Setting - the time and the place of the story is the next question asked to the students as another element of literature. Since there is a flashback in the middle of the story, setting changes in each part. There is both external and internal settings in the story. The first part takes place in the small house of this young couple. It starts in the bedroom at seven o'clock in the morning and goes on all day long. The second part takes place two years ago at the dancing room of the Christmas party that Sam Adams gave and the path they took 'out of the town in the fields' just before going indoors. The last part is back to the present time i.e. the rest of the day when Ted comes back home from work. It is again an internal setting, indoors of their house.

After the setting, the point of view is the other element of the story dealt with. There is third person omniscient narration in the story. The narrator goes into the mind of all the three characters – Ted, Elsie, and Sam Adams. He knows what they think and how they feel. In the opening of the story, the narrator tells us how Whiston feels about his wife saying, 'Her slovenliness and untidiness did not trouble him' (Lawrence, 1977, p. 253) or 'her careless abandon made his spirit glow' (Lawrence, 1977, p. 244). In the scene when Ted gets mad with rage, Elsie knows how Ted feels: 'She knew he was in a state of suppressed irritation' (Lawrence, 1977, p.261). We also learn about how Sam Adams feels via the narrator: 'At that moment Sam Adams appeared, florid and boisterous, intoxicated more with himself, with the dancing, than with wine' (Lawrence, 1977, p.254).

The next question is the characterization and the characters in the story. Students are asked to do close reading and infer meanings. Characters are presented to the readers in four main ways: the narrator comments on the characters and introduces them with their physical characteristics and psychological features; we see characters in action; we know them via the other characters' comments on that character – what they say, how they feel about him; or the flow of the mind of the character is followed and so that the character depiction is done. In 'The White Stocking', Lawrence uses all these methods in presenting his characters.

### **2.3. The Intrinsic Features in Moody's Approach and Scholes's Second Approach in Reading a Text: Reading 'upon' a Text**

The second approach in reading is a step further than that of the first one. Scholes in his first approach to reading a text supports the Saussurean

concept. He claims that linguistic system is referential; it imitates the external world and is created as a reaction to the external world. However, his second approach to reading – reading ‘upon’ a text supports the Derridean concept. In this philosophical outlook, the understanding of the text requires an ‘[attempt] to make the unseen accessible to sight’ (in Barry, 1995, p.71). In contrast to the structuralists, post-structuralists argue that signifiers do not carry with them well-defined signifieds. In their view, meanings are never graspable or as present as it suggests. There is multiplicity of meanings. Language, for post-structuralists, is a system of ‘difference’. The shifts, breaks, omissions, absences in the text reveal that differences are suppressed within the text. The second step in Scholes’ approach is to foreground these ‘differences’ focusing on the symbolic and metaphorical dimensions. Students are asked to do aesthetic reading i.e. experience the text and be a part of the process of creating the text. By means of the transactional experience they go through, they bring their collective subjectivity to the interpretation of the text. If reading ‘within’ a text is the grammatization, reading ‘upon’ is the thematization of the text. Students deconstruct the writer’s text and reconstruct it bringing together both the writer’s and their own experience.

The story opens ‘in medias res’. The very first sentence draws the attention to the relationship between Mrs Whiston and her husband whom she calls in an affectionate and childish way as ‘Teddilinks’ (Lawrence, 1977, p. 244). Readers are introduced to the two main characters from the very first lines of the story with the characters’ words, behaviours and attitudes. Mrs Whiston, whose first name is not stated yet, is lively, energetic and in a hurry. We see her in action but the husband contributes to the characterization of Mrs Whiston as well. The adjectives used for Mr Whiston’s feelings towards his wife in the rest of the same paragraph are ‘pretty,’ and ‘delightful.’ Her carelessness and messiness do not matter for him, instead that arouse his feelings of love for her.

In the first paragraph, the attachment of the husband to his wife is foregrounded. She means a lot to him. She is the source of ‘light and warmth’ for him. It is when she leaves the room, he realizes ‘the raw, cold morning’ (Lawrence, 1977, p. 244). For Whiston’s surprise, she gets up too early that morning. That is unusual for her. When he asks why, her response to him is ‘Nothing. Can’t I get up?’ (Lawrence, 1977, p. 244). This is her usual childish attitude and as it will be seen in the rest of the story, her regular pattern of behaviour. Instead of telling the truth completely, she keeps it to herself first but later confesses it. She does the same that morning. However, Whiston lying in bed, watching his wife doesn’t take it that much seriously as he ‘wonder[s] casually’ the reason for her being so early (Lawrence, 1977, p. 244).

The narrator tells that they had been married for two years. The husband is ‘a shapely young fellow of about twenty- eight’ (Lawrence, 1977, p. 244), has blue eyes and ‘very kind,’ his manner simple’ (Lawrence, 1977, p. 246). He is still in love with and attracted to his wife. The wife, on the other hand, is ‘an untidy minx’ (Lawrence, 1977, p. 244), but she is ‘quick and handy’ washing the supper cups for the breakfast in their fairly small kitchen. With the knock on the door, the reason for Elsie’s impatience is unveiled. It’s Valentine’s Day and she receives gifts from Sam Adams, her former employer and suitor. Her reactions to the presents while opening the envelopes and the boxes are worth to notice in understanding her character. The Valentine’s card makes her only smile briefly. The second packet which is a white cardboard box within which there is a white silk handkerchief with her initials embroidered on it makes her smile also. Yet, the degree of her content increases; she smiles pleasantly this time. Her response to the third envelope differs from the rest. It is another white packet with a white handkerchief neatly folded which she realizes later it to be a white stocking with a little box in the toe. The pearl earrings she finds in the toe of the stocking creates ‘a little flash of triumph’ in her: ‘She had her lower lip caught earnestly between her teeth’ (Lawrence, 1977, p. 245). The way she watches herself with the earrings in the mirror tells a lot. First ‘she went to the mirror,’ but for the second time, ‘she was drawn to the mirror’ (Lawrence, 1977, pp. 245,246). The poesy written for her also flatters her soul. Deep insight, she knows that receiving gifts by another man is not right. When she hears Ted, she ‘start[s] round quickly, guiltily’ (Lawrence, 1977, p. 246). But she is overcome by her vanity. She chooses lying to her husband. She never mentions the earrings; he did not see them in his morning drowsy mood. She conceals them drawing his attention to the other Valentines – the white handkerchief and the cartoon. Yet, even these suffice to rise his jealousy: ‘They’ve no right to send you valentines now’ says Ted (Lawrence, 1977, p. 246). The rate of his anger is reflected in his language as well. He uses dialects such as ‘What ha’ you got?’ She pretends that she doesn’t know who the sender of these gifts is. For the time being, the white stocking he sees on a chair which she tells sent as a sample and the cartoon don’t mean a lot for him. He just takes it as a joke first.

In this marriage, Elsie trusts Ted’s steadiness as she does while ‘clinging round his neck’ letting herself be carried by him (Lawrence, 1977, p. 247). For her, ‘he was so sure, so permanent, he had her so utterly in his power. It gave her a delightful, mischievous sense of liberty’ (Lawrence, 1977, p. 249). She loves Ted, but in time she got used to him ‘as to the air she breathed’ (Lawrence, 1977, p. 260). For her, ‘these giddy little flights’

she takes are innocent, because at the end of the day, she would always go back to him, 'to roost' (Lawrence, 1977, p. 250). Yet, the same is not valid for Ted, who feels that he is completed; found his 'self,' and reached the meaning of his life in this marriage. Elsie's receiving Valentine gifts from Sam Adams leads to a crisis for him and he 'yearn[s] for surety' that he felt is lost that morning (Lawrence, 1977, p. 259).

Elsie is childish, irresponsible and bouncy whereas Ted is dour, dull and steady. She doesn't prefer to take any responsibility in general. She doesn't see any wrong in keeping these rather expensive gifts that Sam Adams sent her on Valentine's Day without considering that they could disturb her marriage to Ted. As a young and a newly married woman, she never receives any such expensive presents from her husband for any occasions. This is her weakness. She is materialistic. She well knows that Ted is unable to give everything she wants and needs also. Besides her interest in precious things, perhaps Elsie is bored with her husband's being such a fixed, real, simple and a direct man. She is in need of some mystery, excitement as Sam Adams ignited in her. Ted is too serious and very much attached to the conscious state of mind and that irritates her.

Elsie unconsciously wants to pull him to his id. Although she knows that he would get very angry if he had learnt all the gifts she received by Adams, she tells him the truth that she lied to him about the white stocking because she is not satisfied with his reaction; she wants to move him more. It wasn't a sample but a Valentine. The stocking, as a sample, was an ordinary object in the beginning for Ted, but when he learns that it was sent as a Valentine, its meaning changes. It has sexual overtures. Elsie succeeds in moving Ted as she wishes. Yet, she still conceals the pearl earrings. The tension rises. Elsie keeps provoking him although she fears his anger. She acts under the influence of her feelings, emotions, and instincts. The husband wants to learn how far his wife is involved with Sam Adams. She goes one step further and without hesitation tells him that she had a drink with him in the Royal. Naturally, Ted starts losing his control. Elsie manages to draw him to his id too and is tense for she is unprepared for what will happen. Being a slave to his uncontrollable anger, Ted insults his own wife saying, 'You'd go off with a nigger for a packet of chocolate' (Lawrence, 1977, p. 249). Elsie feels hurt upon hearing such words. It is too much for her. She is injured. While Whiston feels 'anxious for her' all day long 'yearning for surety,' the moment he leaves the house, she starts enjoying herself in front of the mirror with the pearl earrings which she well knows Ted could not have afforded. She loves her husband and knows that he is steady in his concern for her too. However, marriage for Elsie goes through a change in time:

She was quite happy at first, carried away by her adoration of her husband. Then gradually she got used to him. He always was the ground of her happiness, but she got used to him, as to the air she breathed...Inside of marriage she found her liberty. She was rid of the responsibility of herself. Her husband must look after that. She was free to get what she could out of her time' (Lawrence, 1977, p. 260).

There is a retrospective narrative in the second part of the story which functions as an explanatory section for Elsie's relationship with Sam Adams and the crisis it leads in her marriage to Ted. Sam Adams functions as the 'other' for Whiston. He is a single man of forty with elegant manners and smart appearance and is notorious for his fondness for the beautiful girls. He knows how to impress them. He is a womanizer and is attracted to Elsie, his former employer in his warehouse and Elsie is attracted to him as well. Knowing the ways of the world as an experienced man, with his 'smart navy blue suit, fashionable boots, and manly hat, he [becomes] the irreproachable' for her soon, he succeeds impressing Elsie's attention (Lawrence, 1977, p. 244). It occurs two years ago when Whiston was courting Elsie. They both were young and inexperienced. Upon Adams's invitation, they attend the Christmas party held by him.

Just like the white stocking, Adams's dance to Elsie signifies sensuality. Lawrence employs two sensory perceptions- touching and sight to serve his aim in the story i.e. the conflict that Elsie experiences between her Superego (mind/consciousness) and her Id (feelings, instincts/subconscious). In this triangular relationship, at that Christmas party, Elsie feels entrapped between Ted and Sam Adams unable to find the balance between the two. Since she is too young, she is drawn to the physical pleasure, the vital energy of desire with Sam Adams. Even at the door, Sam Adams makes his male impressiveness felt by her: 'He seized her hands and led her forward. He opened his mouth wide when he spoke, and the effect of the warm, dark opening behind the brown whiskers was disturbing' (Lawrence, 1977, p. 244). Adams, while arranging the first dance with her, since her fiancée does not dance, with an extra advantage, makes her feel his passionate presence again saying, 'I was born with an *amourette* in my mouth' (Lawrence, 1977, p. 252). Although Elsie thinks she can resist his charm, even with the first dance, she is carried away by his magnetism:

He was an excellent dancer. He seemed to draw her close in to him by some male warmth of attraction, so that she became all soft and pliant to him, flowing to his form, whilst he united her with him and they lapsed along in one movement. She was just carried in a kind of strong, warm flood, her feet moved of themselves, and only the music threw her away



from him, threw her back to him, to his clasp, in his strong form moving against her, rhythmically, deliciously (Lawrence, 1977, p. 252).

Elsie, with this pure physical pleasure she takes in the arms of Sam Adams, discovers her Id for the first time, and starts her journey into the depths of her animal nature in her own psyche. For Adams, on the other hand, this seems to be not more than a sensual experience that he could have experienced with any young girl be it Elsie or not:

When it was over, he was pleased and his eyes had a curious gleam which thrilled her and yet had nothing to do with her. Yet it held her. He did not speak to her. He only looked straight into her eyes with a curious, gleaming look that disturbed her fearfully and deliciously. But also there was in his look some of the automatic irony of the roué'. It left her partly cold. She was not carried away (Lawrence, 1977, p. 244).

Elsie, while she loves Whiston, is 'roused to another man' (Lawrence, 1977, p. 254). But still, she is 'driven by an opposite, heavier impulse to Whiston' (Lawrence, 1977, p. 253) who is playing cribbage in another room. She wishes that he could have danced and she could have experienced his 'male warmth of attraction' rather than that of Adams (Lawrence, 1977, p. 252). Yet, the two men are different both in nature and culture. Ted is 'not made that way' (Lawrence, 1977, p. 253). He is the voice of her conscience/superego/mind reminding her of her responsibilities. Although he tells her to enjoy herself, deep insight, she feels him as 'a little tightness, like conscience' (Lawrence, 1977, p. 256). In the cribbage room, just after the dance, in a new state of consciousness and more under the attraction of Adams, when Elsie starts talking to him about the game, Ted gradually realizes that she moves beyond his reach: 'It moved him more strongly than was comfortable, to have her hand on his shoulder, her curls dangling and touching his ears, whilst she was roused to another man' (Lawrence, 1977, p. 254). Ted's presence, as the reminder of what is right or wrong, restrains Elsie while Elsie's stimulation for the voluptuous Adams and her dance with him 'made the blood flame over [Ted]' (Lawrence, 1977, p. 254).

Elsie cannot resist the animal call of Adams to her; she cannot move out of his orbit: 'She went almost helplessly, carried along with him, unwilling, yet delighted' (Lawrence, 1977, p.254). The intoxicating effect of the second dance, how she loses her consciousness moving into her partner's privacy and the intensity of the feelings roused in Elsie as a result of this very close dance is reflected with the word 'delicious.' Both for Adams' and Elsie's physical response to this intimacy is expressed with such words like 'oblivious,' 'concentrated,' 'unseeing,' 'voluptuous,' 'exquisite.' Elsie's loss of her 'self' is expressed as 'fus[ing] down into perfect consciousness' (Lawrence, 1977, p. 254). The language used for the



narration of the dance is abundant with sexual overtures. Their touching bodies arouse the unconscious forces. The dance connects them into one another's deepest passionate parts. Adams's intention is to tempt Elsie to dive into the unconscious state of her being and satisfy this aspect of her being. However, in her case, this leads to a fusion, subsequently leading to the engulfment in the identity of another. This state suggests that Elsie is under the danger of the submersion of her 'self' in the ego of Adams without any being for herself. Elsie's character supports this state, since she is always leaving her own responsibility to the others' hands. Adams gets a temporary hold over her. Nevertheless, getting blind to the external world and consciousness, her realization that Sam Adams will not provide a satisfactory reaction leaving a kiss on her shoulders as she expected causes frustration for her: 'Yet they were not alone, they were not alone. It was cruel' (Lawrence, 1977, p. 255). Adams, on the other hand, 'molten hot' prefers to escape from Elsie pretending to bring some refreshment for her from the dining room (Lawrence, 1977, p. 255).

Elsie's liminal state between the two men and what they signify in her psyche continues. While she's dancing with another man, Elsie is well aware of Whiston's observant presence there, 'like a ghost, or a guardian angel' attempting to bring Elsie back into consciousness (Lawrence, 1977, p. 256). However, although one part of her belongs to him, the other one desperately is drifted by the 'other'/Adams/subconscious/Id. The unexpected drop of a white stocking that Elsie took mistaking as a white handkerchief, in the third dance serves to Adams' further gratification. He sends it as a Valentine in their first anniversary with an amethyst brooch, still attempting to seduce her and it makes a pair with the one sent as another Valentine gift together with a more expensive gift - pearl earrings in their second anniversary. The hidden meaning of the white stocking which signifies nothing as an ordinary item for Ted turns into an erotic object in his mind and causes the crisis and the rise of tension between the two in the last section of the story. It is with the sight, the voice and the compassionate touch of Ted that Elsie wakes up from that unconscious, trance like state of mind. She overcomes the frustration and the feeling of shame caused by Adams with the help of Ted who is 'white-hot with love for her' (Lawrence, 1977, p. 259). It is Whiston who soothes her in his arms with his kisses as they return from the Christmas party.

In the beginning of the third section, it is narrated that Elsie left Adams' warehouse and married Ted. It seems that Ted chose forgetting about the white stocking. They just left the matter unresolved. Although the meaning of this marital union meant different for each, they had been living happily. Ted, at least, used to feel 'surety' for his wife's love and loyalty so far. However, that morning Sam Adams and his ongoing

attempts of seducing Elsie with the luxurious gifts and the white stockings he sends for Valentine gifts since their first anniversary i.e. for two years, causes a crisis in their relationship. This last part is a return to the same day that they had breakfast and Ted had to leave her feeling anxious with many questions in his mind. He is back from work tired and depressed.

These gifts may have triggered somewhere in Elsie since her uncontrollable, instinctive side reemerges. She starts making mock of her husband and jeering at him; finding excuses to be against him. This makes him angry. She could read it both by his looks, his frown brows and also his strong 'brutal' voice. All day long, he suppresses his irritation. He wonders why she is hoarding up the stocking in her drawer instead of putting it on the fire. Elsie adds more fuel to the fire, telling Ted that she got a pair. She has a strange desire in her to taunt him more unable to move him. She goes upstairs; wears them on and shows her legs in the stockings that Sam Adams sent her provoking him deliberately by saying also that that saves him from buying a pair. She starts dancing round the room, singing, lifting and kicking up her legs at him. She does all these fearing, but keeps goading him in the same way, although she sees his 'lighted, dangerous eyes' (Lawrence, 1977, p. 262). She rejects his orders that she should put them on the fire. Instead, Elsie seems gay, disrespectful and indifferent in her behaviours towards her husband. Differently from two years ago, as a married woman, now she seems to have achieved a new awareness for the power in herself to arouse emotions in men. That's what she's doing to her husband. Following some months after her marriage, she had met Sam Adams and then had realized that Sam Adams was in love with her. His desire was left unsatisfied and this was the reason for his continual sending of luxurious gifts to her every year for Valentine's Day especially. Elsie well knows that she cares not for the man but she just enjoys herself playing with him only for ego gratification. Her interest for Adams was temporary. It is Ted whom she cares as a man. Yet, she thinks there's nothing wrong in keeping the jewellery.

Lawrence's description of the dance Elsie and Adams had was symbolically associated with love-making. Elsie's single dance around the room, lifting her skirt to her knees and kicking her legs up at her husband to expose her nice legs in the white stockings carries also an erotic meaning. Elsie wants to be the centre of her husband's attention and hear praises by him. Since these stockings remind Ted of the betrayal of his love, this is impossible for Ted. His manners and the tonality of his words reflect his present state of mind. They both utter bitter words to each other. She rejects being told what she must do asserting her own will. Ted comes to the point of calling her 'trollops,' 'nasty trolley.' Lastly, he even calls her as 'stray-running little bitch' (Lawrence, 1977, p. 262). He knows that she

would love that Sam Adams see her wearing them. Therefore, his anger grows and turns into hatred against her behaviours and her words telling him that '[her] legs are [her] own. And why shouldn't Sam Adams think they're nice?' (Lawrence, 1977, p. 262) When he learns that she spoke to him when she had seen him, Ted threatens her with breaking her neck. Elsie finds him 'so common and beastly' (Lawrence, 1977, p.263). Yet, she is still haughty and cold towards him although she is very frightened indeed.

Ted has always been the voice of the conscious for Elsie. His love was pure and real. Adams' hold over Elsie was temporary. She realizes that her attraction to Adams was only sensual without any spiritual satisfaction. Ted, on the other hand, is a challenge for Elsie representing the values different from that of Adams. He is like 'a ghost, or a judgement, or a guardian angel' for her (Lawrence, 1977, p. 256). As she clearly had expressed her wish that she could have danced to Whiston at that party and have experienced that physical pleasure with him, Elsie wants him to satisfy this aspect of her being. It is for this reason perhaps she pulls Ted down to the unconscious state goading him unceasingly. She wonders the extent of how much deep Ted will dive into his dark side. Ultimately she succeeds in her goal. The effect of her mocking makes him 'white-hot, molten' (Lawrence, 1977, p. 263). Ted loses his contact with the outside world. Losing his mind, acting in accordance with his animal nature, Ted's eye is 'unseeing' being unconscious; comes even to the point of desiring to kill her.

Besides the imagery of touch, Lawrence uses the eye imagery in his story to reflect the painful feelings of both characters. As Ted's anger becomes uncontrollable, Elsie's eyes are 'big, sullen and childish' watching him feeling not pain as Ted did but fear (Lawrence, 1977, p. 263). Elsie acts on revenge telling him the truth about Adams's earlier gifts of an amethyst brooch from last year and a pair of pearl earrings he sent this year. It ends up with Ted's loss of his temper and a strike to Elsie's mouth. Lawrence reflects the pain she feels with the eye imagery again: she covers her 'wide-staring eyes;' 'her big, black, childish eyes watched him, fascinated, held in her spell;' her eyes are 'all forlorn and pathetic' (Lawrence, 1977, pp. 264,265). Lawrence uses 'sight' and the eye imagery in the depiction of Ted's jealous rage as well. Ted wants satisfaction, the gratification of his desire but it is in a different form. He wants to destroy her: 'his lust to see her bleed' (Lawrence, 1977, p. 264); he fixes his eyes which 'were glowing again' upon his target (Lawrence, 1977, p. 264); when saw 'the blood mark' (Lawrence, 1977, p. 265), 'he looked at her in contempt and compassion and in rising anger' (Lawrence, 1977, p. 265). Until the blow, Elsie was assertive and also stubborn like

a child as before while she was doing her single dance in front of her husband. This was new for her in the sense that two years ago, she had fused, molten and yielded her 'self' to the hands of Adams in the dance taking not even her own responsibility. However, with the blow, she once more yields to a man – Ted and his authority. She is shocked and she too is unconscious at that moment. Even the blood at her mouth cannot stop the 'black storm of rage' in Ted (Lawrence, 1977, p.263). It is only when he realizes that her involvement with Sam Adams is nothing to do with what he thinks it is, he quits. He also recognizes that she kept the gifts just because they were jewellery. It is when Ted's judgement of the objects changes, they lost their erotic association: 'it's none of their fault' (Lawrence, 1977, p. 265). He packed them all neatly and posted them back to Sam Adams feeling sick and tired. Interestingly, it's another type of touch, i.e. Ted's blow on Elsie's face acts as a restoring force to provide a flow of feeling between them. Elsie has upset the conscious for the sake of the unconscious. This reminds us of the scene at the end of the party, when Elsie in a regretful mood asks Whiston in tears 'be good' to her and 'was restored at last' in Whiston's arms with his tender and compassionate touch (Lawrence, 1977, p. 259). There is nearly the recurrence of the same scene at the closing of the story. They turn back to their old selves: Elsie is the same irresponsible, childish 'pretty little thing' 'let[ting] herself be taken' by Whiston; sobbing aloud; asking for forgiveness of Ted saying him 'I never meant' (Lawrence, 1977, p. 266). Ted, on the other hand, is the same authority that restores Elsie holding her in his arms.

The ending of the story is open to discussions. Elsie who challenges her husband with the dance she makes in the white stockings seems to be determined to take the control of her life in her hands. It is true that she is selfish, vain and has a weakness for luxurious objects. Yet, whether she deserves such a vulgarity and physical violence by her husband is still debatable. Elsie looks for a new excitement in their relationship. She pushes the limits of Whiston's tolerance. She used to be happy in this marriage knowing that he is for sure there for her and was content with the limitations defined in her husband's dominion. She was about to change it, but failed. When Ted tells Elsie to bring the jewels from upstairs, Ted too seems to have realized that his brutal blow was wrong and doesn't convey any warning for Elsie: "'I won't,' she wept, with rage. 'You' re not going to bully me and hit me like that on the mouth'" (Lawrence, 1977, p. 265). Elsie used to reject any responsibility of herself thinking that it should be taken care by her husband. The scene when the white stocking is accidentally dropped on the dancing floor and Sam Adams picked up recurs at the end. Elsie keeps finding herself in a difficult situation caused

by her own behaviour and Whiston takes the initiation to restore the situation. The closure of the story makes two options possible: Either Elsie will be behaving in the same way and Ted will accept her as she is and they live happily ever after or as the circular structure of the story points out, Ted's physical violence to check his dominion upon his wife will continue.

While reading 'upon' the story in the light of Scholes's approach, having discussed the symbolical and metaphorical meanings, students focus on the themes dealt with in the story. Some themes in this short story can be taken as the male-female, the intellect and the instinct, the conscious and the unconscious oppositions, marriage relationship, sensuality, vanity, materialism, the balance between the body and the soul, spiritual satisfaction, physical desire and violence. Some major messages that can be drawn out of these messages can be stated as follows: Love demands a balance between body and soul; in order to have a healthy ego, one has to have a balance between the superego and the id; and marriage doesn't mean submersion of self in the ego of another.

Lastly, students' attention is drawn to the title which Lawrence chooses to serve to the whole of the story. Stockings are pieces of women's clothing which are usually made of nylon or silk and fit closely over the feet and legs and are held fixed by suspenders. They are associated with eroticism, sensuality, and sexuality. Choosing the title as 'The White Stocking' in singular form, the writer makes a reference to the stocking which is dropped accidentally on the floor of the dancing room and kept by Sam Adams as a sign of his triumph. The same stocking starts the crisis in the marriage of the main characters - Ted and Elsie when Sam Adams disturbs their marriage sending it as an unexpected Valentine's gift together with rather expensive presents such as an amethyst brooch and a pair of pearl earrings.

### **Conclusion**

Using literary texts in language learning classes is beneficial in many respects. Literature contributes to the learners' linguistic competence, increases their language awareness, as well as their knowledge about the culture of the target language that they are learning. Besides, it teaches students critical and creative thinking. It increases their self-knowledge; does a positive effect in their affective engagement. As a result, it contributes to their personal growth developing empathy and tolerance for the others in them. As an outcome of all these texts, being imposed to very many different themes and characters in the fictional worlds they are presented, they become respectful for the new opinions different from that of theirs. While analysing the texts, they also improve their problem solving skills. With the right selections appropriate for the learners' interest, needs, and

language levels, they are personally involved and excited about the reading process and become motivated.

Yet, there is no certain formula in teaching literature or using it in language classes. However, one can use it for different purposes. It can be used as a tool to teach linguistic aspects of the language focusing only on the grammatical, lexical usages to improve four skills and vocabulary repertoire. As another way, it can be taken as the content of the course. It is then the genre, the social, historical, political background of the text, the style of the author, and the artistic usage of the language embedded with the literary figures of art such as simile, metaphor or imagery are foregrounded in the reading process. Since their approaches to reading enables using a literary work both as a tool and the content, in the analysis of D.H. Lawrence's 'The White Stocking' as a sample text, H.L.B. Moody's and Robert Scholes' methodologies have been used as a model.

## WORKS CITED

- Barry, P. (1995). *Beginning Theory; An Introduction to Literary and Cultural Theory*. Manchester: Manchester University Press.
- Bozer, D. (1995). An Analysis of a Short Story. *Journal of English Language and Literature*. No.3, pp.83-88.
- Brown, H.D. (2001). *Teaching by principles: An interactive approach to language pedagogy*. 2nd Ed. New York: Addison Wesley Longman.
- Brumfit, C.J. (1983). *Teaching Literature Overseas: Language-Based Approaches*. Oxford: Pergamon Press.
- Holman, C.H. (1972). *A Handbook of Literature*. New York: The Odyssey Press.
- Lawrence, D.H. (1977). *The Complete Short Stories*. Volume I. Harmondsworth, Middlesex: Penguin Books.
- Moody, H.L.B. (1971). *The Teaching of Literature*. London: Longman.
- Nuttall, C. (1996). *Teaching reading skills in a foreign language*. Oxford: MacMillan Publishers.
- Scholes, R. (1985). *The Textual Power; Literary Theory and the Teaching of English*. London: Yale University Press.
- Shaw, V. (1986). *The Short Story: A Handbook of Critical Introduction*. London and New York: Longman.





“

## Chapter 19

**DETERMINING THE FACTORS  
AFFECTING THE SELECTION OF  
RESEARCH ASSISTANT AND RANKING  
OF IMPORTANCE: EXAMPLE OF  
MANAGEMENT INFORMATION  
SYSTEMS DEPARTMENT**

*Fatma AKGÜN<sup>1</sup>*

*Alper AYTEKİN<sup>2</sup>*

”

---

1 AKGÜN Fatma , Research Assistant, Bartın University, Department of Management Information Systems, OrcidID : 0000-0002-7380-9463.

2 AYTEKİN Alper , Research Assistant, Bartın University, Department of Management Information Systems, OrcidID : 0000-0002-2756-7870

## 1. Introduction

With globalization, information has become the most important power element of our age. Although it is difficult to obtain, store and protect information, it is an element that makes people strong. The era we live in is called the information age. With knowledge many things can be controlled and progress is made. Science advances in the light of knowledge. With new knowledge on the ground, science is making progress by going one step further. Information is an explanation of how a phenomenon or events occur. The way the knowledge emerges or the type of phenomenon it explains is important in terms of the type of knowledge. Scientific knowledge, one of these types of knowledge, also forms the basis of academic life.

In the element we call scientific knowledge, it emerges and is explained by experiment, observation or reason. The most important feature of scientific knowledge is that it is objective. Again, scientific knowledge has many features. These; It has many features such as being consistent, being open to criticism and being consistent. Scientific knowledge is revealed by scientists and this information is generally accepted and proven information.

A scientist is a person who uses scientific methods to reach scientific knowledge. The term scientist was first used in 1833 . William Whewell used by. Its importance increased especially at the end of the 19th century. Scientists try to understand and explain the factors related to human and nature. To date, the roles and qualifications of the scientist have evolved over many years to become what they are today. Scientists have been the pioneers of society in every age and have given direction to that society. Societies around science have always made progress.

The way to progress on the path of scientist passes through academia. Academies, namely universities, are one of the most important factors in the disclosure and dissemination of scientific knowledge. It provides scientific progress with research activities carried out with faculty members and lecturers at universities. These institutions constitute a scientific structure. Research assistants constitute the lowest base of the scientific structure created. Foundations in buildings are the most important element. Because the structure progresses over the foundation. The selection of research assistants, who are the foundation of the academy, is very important, as the foundation will be solid if the foundation is laid. When YÖK data is examined, it is seen that the majority of the academic community consists of research assistants. In Figures 1 and 2, the numbers of academicians according to their titles are obtained according to foundation and state universities.

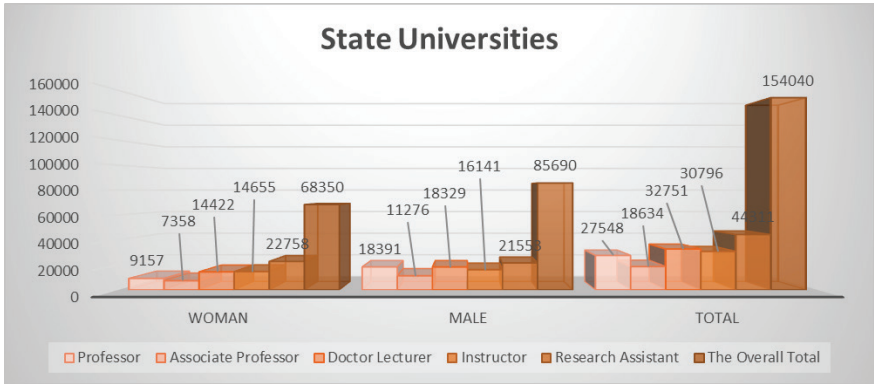

**Figure 1.** Distribution of Academic Staff at State Universities (Resources: YÖK data)

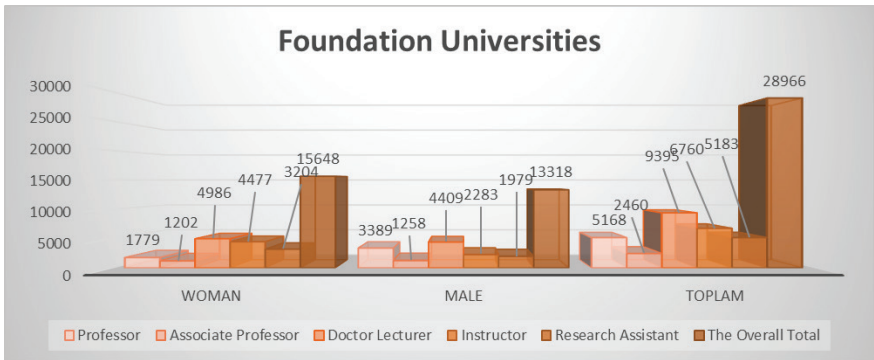

**Figure 2.** Distribution of Academic Staff at Foundation Universities (Resource: YÖK data)

When figures one and two are examined, it is seen that there are significant differences between the number of academic staff of foundation and state universities. The number of research assistants in both state and foundation universities is considerably higher than the number of lecturers in other titles. This shows that research assistants, who form the core of the academy, have an important influence. Because the way to go to advanced titles is through being a research assistant. Among the research tasks at the bottom of this hierarchy, there will be people who will shape science in the future. For this reason, the criteria to be applied in the recruitment of research assistants should be determined better. This is a very difficult and complex process. Because there are many criteria that can affect the intake, their effect values and importance are different from each other.

Decision-making actions bring along complex problem-solving processes. While performing the decision-making action, it comes with many factors that affect this decision. The decision maker evaluates

many factors/ criteria and tries to choose the most suitable one among the alternatives. In this very complex process, multi -criteria decision making methods (MCDM) both provide convenience and guide the user, that is, the decision maker. MCDM is widely used in solving problems thanks to its ease of use. There are many methods among MCDM techniques. The most widely used of these methods is the analytical hierarchy process (AHP). The AHP method is basically based on the same logic and it evaluates many criteria at the same time and guides the decision maker in choosing the most suitable alternative. The AHP method was first introduced by Saaty in the late 1970s. The simplicity and clarity of the method has led to its widespread use. With the AHP method, both subjective and objective decisions can be evaluated simultaneously. The AHP method offers analytical solutions to the decision maker regardless of the number of criteria.

The qualifications of research assistants who will start working in their academic units are important for decision makers. Because many academic and administrative works of the relevant unit are carried out by research assistants. In this study, the criteria to be considered in the selection of research assistants, which form the basis of the academic community, will be discussed. Because research assistants are very important factors in shaping the future.

Within the scope of the study, the factors that are effective in the selection of research assistants were determined and the order of importance of these factors was tried to be made. The prepared study consists of six chapters. In the first part; by introducing the subject, general information was given and the subject and its importance were tried to be explained. In the second part; by making a literature study related to the subject, the scope, purpose and original value of the study, which is not in the literature, are included. In the third part; the criteria to be used in the research are mentioned. In the fourth chapter; The method to be used in the study is mentioned. In the fifth section; The implementation phase of the research is included. In the sixth chapter, the results are interpreted and suggestions for future studies are presented.

## **2. Literature Review**

A detailed literature review related to the subject of the study was made. There are not many studies directly related to the subject. Although there are few studies on the selection of academic staff, some restrictions have been brought to the subject in order to be different from other studies and to contribute to the literature.

The aim of the study is to determine the factors to be considered in the selection of research assistants for management information systems, which

have not been mentioned before, and to rank them in order of importance. Thus, a table has been tried to be presented for decision makers to use in their decision-making actions. There is a detailed literature study in Table 1.

**Table1.** *Studies with MCDM Method*

Year	Author(s)	Findings of the Research
2005	Bali and Gencer	In the study, instructor selection was made using the Fuzzy AHP method.
2007	Dagdeviren	In the study, the manager was selected by using the Fuzzy AHP method.
2007	Gibney et al.	In the study, dean selection was made using the AHP method.
2010	Aksakal and Dagdeviren	Personnel selection was made by using DEMATEL and ANP methods in the study.
2012	Kabak and Kazancoglu	In the study, teacher selection was made using the Fuzzy AHP method.
2012	Zolfani et al.	In the study, principal selection was made using AHP and COPRAS methods.
2013	Köse, Aplan and Kabak	In the study, academic staff selection was made by using ANP, ELECTRE, TOPSIS, GANP techniques from MCDM methods.
2013	Bali	In the study, the instructor selection was made using the Fuzzy VIKOR technique.
2013	Rouyendegh and Erkan	In the study, academic personnel were selected by using Fuzzy AHP and Fuzzy ELECTRE methods.
2014	Koyuncu and Ozcan	In the study, personnel selection was made using AHP and TOPSIS methods.
2014	İbicioğlu and Unal	In the study, the manager was selected by using the AHP method.
2014	Dogan and Önder	In the study, personnel selection was made using AHP and TOPSIS methods.
2014	Vatansever and Öncel	In the study, academic personnel were selected by using Fuzzy AHP and Fuzzy TOPSIS methods.
2017	Öneren, Arar and Çelebioğlu	In the study, the factors in the recruitment of research assistants were determined by using the AHP method.
2018	Celikbilek	In the study, manager selection was made using AHP and MOORA methods.
2020	Ozturk et al.	In the study, personnel selection was made using the VIKOR method.
2021	Yorulmaz and Yanik	In the study, manager selection was made using the AHP method.

### 3. Criteria Used

Although there are many issues to be considered while selecting academic staff, the recruitment is made in accordance with certain general conditions. The conditions in the advertisements are as in table 2 below.

**Table 2.** *Requirements for CoHE Research Assistant*

<b>1</b>	To meet the conditions specified in Article 48 of Law No. 657,
<b>2</b>	be under the age of 35
<b>3</b>	Absence of any health problems that may prevent him from doing the job
<b>4</b>	Having received at least 70 points from the Academic Personnel and Graduate Education Examination,
<b>5</b>	Having received at least 50 from one of the ÜDS/KPDS/YDS/YÖKDİL foreign language exams,
<b>6</b>	Having a master's degree with a thesis or having done

If the conditions in the table above are met, the right to apply for the exams opened in universities is gained. These conditions are the conditions that must be met at the minimum level. Apart from these, conditions such as a specific undergraduate program and field of study can be placed on the positions opened by universities. Candidates who meet these requirements at a minimum level are entitled to take the science exam by making their applications. These candidates are ranked according to the coefficients determined by YÖK . Because 10 times the number of positions opened for the science exam, candidates are accepted.

Candidates who meet the conditions determined by YÖK enter the science exam prepared by the commissions in the relevant units of the universities. Science exams consist of two stages. The first is a written science exam and the second is an oral science exam. After the candidates take the exam, the ranking of the candidates is determined by the coefficients determined by YÖK. 20% of the candidates' undergraduate grade point average, 25% of the (ALES) score, 40% of the Area Exam Score and 15% of the Foreign Language Exam Score, if any, will be taken into consideration. Since the number of recruitments will be made in the announced cadre, the candidates who are at the top of the ranking are deemed to be entitled to become a research assistant.

The conditions in the recruitment of a research assistant do not fully indicate the suitability of the person to be recruited for the relevant unit. Because the conditions required by YÖK are general conditions, regardless of department. However, candidates who come to each department with general conditions are not eligible. Especially in applied sciences, the conditions should have more specific features. Because the research assistant recruited to the relevant unit does not only perform academic activities, but also performs administrative activities. Therefore, the suitability of the candidate to the relevant unit should be examined more and specific conditions should be sought.

Although there is a general requirement of YÖK in the selection of

research assistants, since these conditions do not fully reflect the required qualifications, the managers of the relevant units were contacted and asked about the factors to be considered while hiring research assistants. Face-to-face interviews were conducted with three experts and the criteria in Table 3 below were determined.

**Table 3.** *Factors Influencing the Selection of Research Assistant*

1	Scientific Competence
2	Ability to Understand and Explain
3	Foreign Language Skill
4	Having a Critical Perspective
5	Analytical Thinking Skill
6	Working Discipline
7	Technology Information
8	Suitability for Team Spirit
9	Solution Focused
10	Ability to Communicate
11	Ability to Take Risks and Make Decisions
12	General View
13	Age
14	Experience

Criteria mentioned above were determined in line with the opinions of the experts and it was decided to use them in the research.

#### **4. Analytical Hierarchy Process (AHP)**

The AHP method was introduced by Saat at the end of the 1970s (Tüminçin, 2016). It is the most preferred method among MCDM techniques. One of the most important factors in choosing the method is that it offers the opportunity to evaluate both qualitative and quantitative variables together (Wu, 2010). The AHP method is a mathematical method (Dağdeviren and Eren, 2001). AHP is frequently used in the literature due to its ease of use (Aytakin et al., 2021). Because AHP is the most easy to use and understand method (Punniyamooty , 2012). AHP helps the decision maker to choose the most suitable one among the alternatives by grading the criteria in the solution of very complex problems. The AHP method models the current problem in a hierarchical structure, making the relationships between criteria and alternatives visible. The relationship between layers in the hierarchy is unidirectional ( Liberatore and Nydick , 2008). The top layer of the model, which is created as a hierarchical structure, consists of main criteria, sub-criteria and alternatives after the goal to be achieved (Scholl, 2005). The hierarchical structure of AHP is as shown in figure 1.

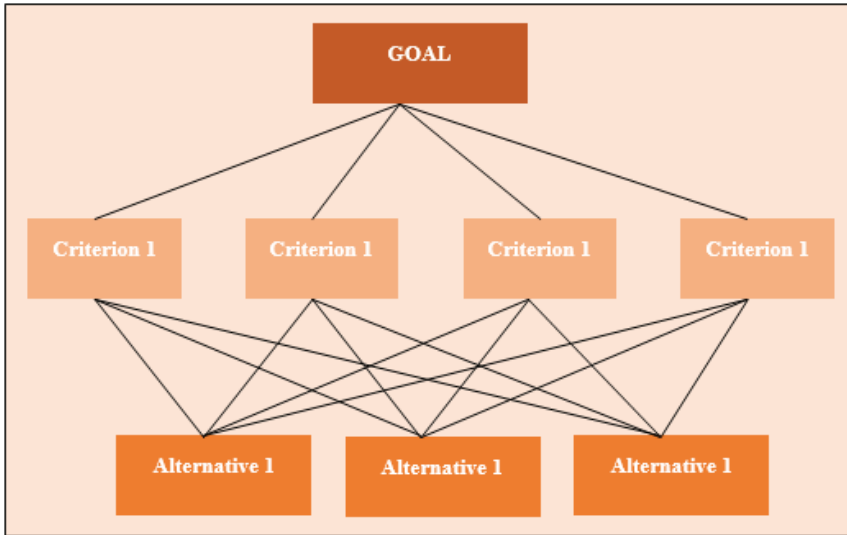

**Figure 3.** *AHP Hierarchical Structure*

It is effective in choosing the AHP method that it provides fast and effective decisions to decision makers. Because each factor in the decision-making structure prolongs the decision-making process and reduces the effectiveness of the decision. The AHP method includes the steps indicated in the figure below.

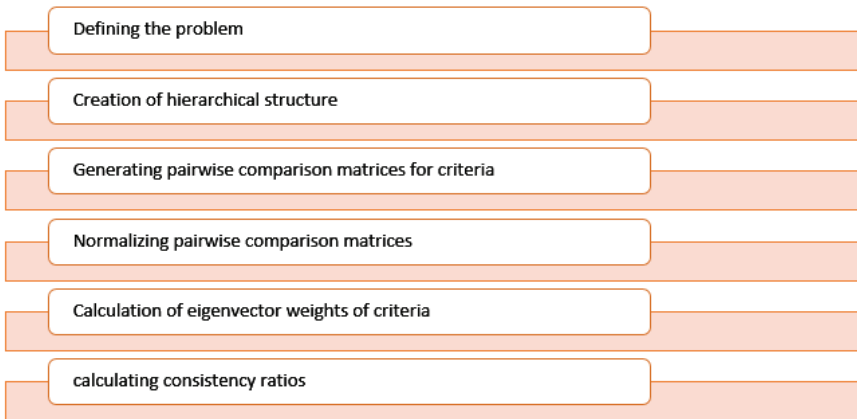

**Figure 4.** *AHP Steps*

Scale developed by Saaty in the 1980s is used to evaluate expert opinions. Table 4 shows the scale used



**Table 4.** *AHP 1 – 9 Scale*

<b>Explanation</b>	<b>severity level</b>
Equally important	1
moderately important	3
Quite Important	5
Very important	7
Highly important	9
Intermediate Values	2,4,6,8

In the AHP method , the criteria , sub-criteria and alternatives are subjected to pairwise comparison and their importance values are calculated. If an alternative is to be determined in the method, each alternative is subjected to a pairwise comparison with the determined criteria , and their weights are determined and these weights are ordered from largest to smallest. The steps used in calculating the importance of criteria are given in Table 5 below .

**Table 5.** *AHP Process Steps*

1- According to the scale in Table 4, B decision matrices are formed based on the opinions of the experts.	$B = \begin{bmatrix} x_{11} & \dots & x_{1k} \\ \vdots & \ddots & \vdots \\ x_{l1} & \dots & x_{lk} \end{bmatrix}$
2- The geometric mean of Decision Matrices is found.	$C_{nm} = \sqrt[k]{X_{nm}^{(1)} * X_{nm}^{(2)} * \dots * X_{nm}^{(k)}}$
3- A new F decision matrix is created as a result of the geometric mean.	$F = \begin{bmatrix} x_{11} & \dots & x_{1m} \\ \vdots & \ddots & \vdots \\ x_{n1} & \dots & x_{nm} \end{bmatrix}$
normalizing the F matrix , [ c <sub>ij</sub> ] matrix is obtained.	$c_{ij} = \frac{x_{ij}}{\sqrt{\sum_{b=1}^a x_{bj}^2}}$
The weight values are obtained by dividing the sum of the row values of the C matrix by the number of criteria (n).	$w_i = \frac{\sum_{b=1}^a C_{ij}}{n}$
6- The λ value is calculated.	$\lambda = \frac{\sum \frac{d_i}{w_i}}{n}$
7- (CR) consistency is calculated. (CR< 0.1 )	$CR = \frac{(\lambda - n)/(n - 1)}{RI}$

**Table 6.** *Random Index (RI) Values*

Number of Criteria	1	2	3	4	5	6	7	8	9	10
<b>RI Value</b>	0	0	0.52	0.89	1.11	1.25	1.35	1.40	1.45	1.49

Purpose of the consistency analysis, which is one of the important decisions of the AHP, is to determine whether the decision maker behaves consistently when comparing the criteria (Tüminçin, 2016). Consistency, that is, the CR value should be  $< 0.1$ . If the ratio is large, it should be checked by returning to the pairwise comparison matrix. The fact that the number of criteria determined in the study is high reduces the probability of obtaining consistent results in the analysis ( Kwiesielewicz and Uden , 2004: 712-712).

## 5. Application

### a. Purpose and Importance of the Research

In the study, the selection problem of the research assistants, who form the backbone of the academy, was discussed. The selection of a research assistant involves a very complex and challenging process for the relevant unit managers who are decision makers. The decision maker has to consider many factors when choosing a research assistant for his unit. This situation makes the process inextricable. The aim of the research is to determine the criteria to be considered in this difficult process and to rank the importance as a result of the opinions received from the experts in order to guide the user. Thus, it is desired to facilitate the decision-making actions of decision makers. In the study, when a detailed literature review was made, studies were carried out that included the criteria to be considered in the selection of academic staff. But these studies have been done in general. In other words , it was made without any specific section or scientific distinction. Starting from this point, the factors in the relevant literature were added to these, based on the criteria determined by YÖK . However, when the expert of the subject was consulted, these criteria were not sufficient. The criteria obtained were expanded by taking the opinions of the experts and transformed into the form used in the study. At this point, the research is important in terms of its widespread effect.

### b. Limitations of the Research

Considering some conditions that may cause differences in the evaluation of criterion weights in the research , the research has been advanced in this context. The first and most important of these limitations is the determination of the relevant unit from which a research assistant will be recruited. The relevant unit has been determined as management information systems.

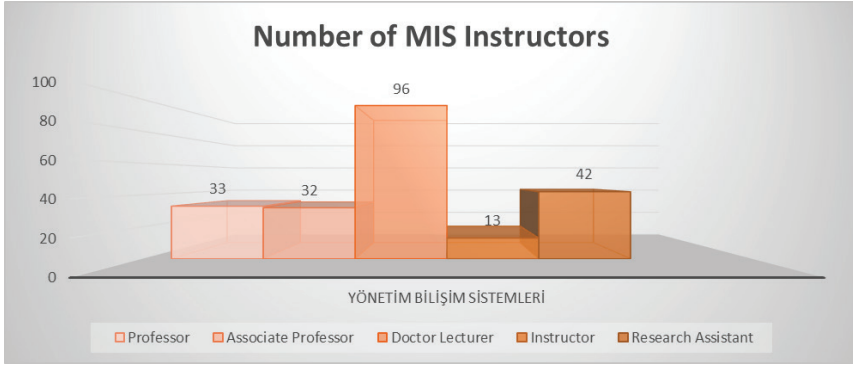

**Figure 5.** MIS Instructor Table (Source: YÖK Data)

As can be seen in Figure 5, management information systems is a new field and the number of teaching staff is quite insufficient. It is a newly opened department in our country. By evaluating this feature, research assistants to be trained can be selected more carefully and the future of the department can be directed. Thus, it proceeds to become a department that can do better and last longer.

In this field, it is easier to obtain data and management information systems is a discipline. The fact that this department is a discipline has caused it to be associated with many sciences. Therefore, different specific criteria can be sought in the recruitment of research assistants. Since the features of management information systems in Turkey vary according to universities, seven experts were selected from different universities to be consulted. The geometrical averages of the results were taken by selecting experts from different universities.

### c. Findings of the Research

AHP method was used to determine the importance of the main criteria and sub-criteria. Expert opinions were obtained using the 1-9 scale. Experts working in three different companies were consulted in order to reflect different views and characteristics. These three experts were selected from three different regions, taking into account the factors that are likely to affect the outcome.

1. Step 2: A single pairwise comparison matrix was created by combining the opinions of the experts with the geometric mean. The pairwise comparison matrix created for the criteria is given in Table 7.

**Table 7.** Geometric Mean Matrix of Main Criteria

Criteria	BY	AAK	YDB	EBAS	ADB	CD	TB	TRU	COO	IK	RAKV	GG	Y	D
<b>BY</b>	1.00	0.99	0.73	3.47	3.47	1.58	0.67	0.67	3.47	3.47	3.47	3.47	4.65	3.00
<b>AAK</b>	1.01	1.00	1.37	3.00	2.19	1.00	1.09	3.00	1.00	3.00	3.00	2.36	4.65	0.85
<b>YDB</b>	0.73	0.46	1.00	3.23	1.60	1.00	0.85	2.36	1.60	0.49	0.67	1.47	3.23	1.60
<b>EBAS</b>	0.29	0.33	0.22	1.00	0.33	0.22	0.31	0.32	0.33	0.46	0.46	0.46	3.23	1.60
<b>ADB</b>	0.29	0.46	2.19	3.00	1.00	0.62	0.46	3.00	0.73	1.00	3.00	3.23	3.23	2.19
<b>CD</b>	0.63	0.62	2.56	4.65	1.60	1.00	0.73	3.16	1.60	3.16	3.00	2.36	4.32	2.31
<b>TB</b>	1.49	0.67	2.56	3.23	2.19	1.37	1.00	4.65	2.19	2.19	4.65	3.23	4.32	2.31
<b>TRU</b>	0.79	0.33	0.42	3.16	0.25	0.32	0.22	1.00	0.33	0.33	0.62	1.47	3.00	1.49
<b>COO</b>	0.29	0.62	0.62	3.00	0.62	0.62	0.46	3.00	1.00	2.19	3.00	1.60	3.00	1.60
<b>IK</b>	0.29	0.33	0.46	2.19	1.60	0.32	0.46	3.00	0.46	1.00	3.00	3.00	3.00	1.49
<b>RAKV</b>	0.29	0.33	0.46	2.19	0.33	0.33	0.22	1.60	0.33	0.33	1.00	0.85	3.00	1.49
<b>GG</b>	0.29	0.42	0.39	2.19	0.62	0.42	0.31	0.68	0.62	0.33	1.17	1.00	3.00	1.49
<b>Y</b>	0.22	0.22	0.31	0.31	0.31	0.23	0.23	0.33	0.33	0.33	0.33	0.33	1.00	0.31
<b>D</b>	0.33	0.53	0.62	0.62	0.46	0.43	0.43	0.67	0.62	0.67	0.67	0.72	3.23	1.00

2. Step 2: A normalized decision matrix is created to evaluate the main criteria.

**Table 8.** Normalized Comparisons of Key Criteria

Criteria	BY	AAK	YD	EBAS	ADB	CD	TB	TRU	COO	IK	RAKV	GG	Y	D
<b>BY</b>	0.13	0.13	0.05	0.10	0.21	0.17	0.09	0.02	0.24	0.18	0.12	0.14	0.10	0.13
<b>AAK</b>	0.13	0.14	0.10	0.09	0.13	0.11	0.15	0.11	0.07	0.16	0.11	0.09	0.10	0.04
<b>YD</b>	0.09	0.06	0.07	0.09	0.10	0.11	0.12	0.09	0.11	0.03	0.02	0.06	0.07	0.07
<b>EBAS</b>	0.04	0.05	0.02	0.03	0.02	0.02	0.04	0.01	0.02	0.02	0.02	0.02	0.07	0.07
<b>ADB</b>	0.04	0.06	0.16	0.09	0.06	0.07	0.06	0.11	0.05	0.05	0.11	0.13	0.07	0.10
<b>CD</b>	0.08	0.09	0.18	0.13	0.10	0.11	0.10	0.12	0.11	0.17	0.11	0.09	0.09	0.10
<b>TB</b>	0.19	0.09	0.18	0.09	0.13	0.14	0.13	0.17	0.15	0.12	0.17	0.13	0.09	0.10
<b>TRU</b>	0.10	0.05	0.03	0.09	0.02	0.03	0.03	0.04	0.02	0.02	0.02	0.06	0.06	0.07
<b>COO</b>	0.04	0.09	0.04	0.09	0.04	0.07	0.06	0.11	0.07	0.12	0.11	0.06	0.06	0.07
<b>IK</b>	0.04	0.05	0.03	0.06	0.10	0.03	0.06	0.11	0.03	0.05	0.11	0.12	0.06	0.07
<b>RAKV</b>	0.04	0.05	0.03	0.06	0.02	0.04	0.03	0.06	0.02	0.02	0.04	0.03	0.06	0.07
<b>GG</b>	0.04	0.06	0.03	0.06	0.04	0.04	0.04	0.02	0.04	0.02	0.04	0.04	0.06	0.07
<b>Y</b>	0.03	0.03	0.02	0.01	0.02	0.02	0.03	0.01	0.02	0.02	0.01	0.01	0.02	0.01
<b>D</b>	0.04	0.07	0.04	0.02	0.03	0.05	0.06	0.02	0.04	0.04	0.02	0.03	0.07	0.04

3. Step: The weight values of the main criteria are calculated.

**Table 9.** Weight Values of Main Criteria

criteria	BY	AAK	YD	EBAS	ADB	CD	TB	TRU	COO	IK	RAKV	GG	Y	D
<b>Weights</b>	0.13	0.11	0.08	0.03	0.08	0.11	0.14	0.05	0.07	0.07	0.04	0.04	0.02	0.04

4. Step 2: After the weighting process, the CR value is found to test the consistency of the model.

**Table 10.** *Consistency Values of Key Criteria*

Landa	CI	CR	
14.88	0.068	0.043	<0.10

To test the consistency of the model, consistency analysis was performed by calculating the CR value. Since the CR value was  $0.04 < 0.1$  in the analysis, our model was consistent.

## 6. Conclusion

With globalization, the power of information is increasing. Although the process of obtaining information and controlling and storing this information is quite difficult and complex, it is the most important factor that makes people strong. Human beings tend to investigate and explain some events and phenomena from past to present. This trend constantly increases the power of knowledge. Because knowledge has a quality that explains all events and phenomena. This is where the power of the knowledge people acquire comes from. Knowledge is a basic requirement for societies to progress. Because knowledge emerges as a result of some systematic research.

It increases the value of information by calling the age we live in as the information age. Information accepted by the society and proven to be correct is called scientific knowledge. Scientific information is revealed by scientists. Scientists obtain information by systematically conducting experiments and observations. And they are trying to direct the society with the knowledge they have obtained. The progress and development of societies is thanks to scientists who can go beyond their age. The academy, where scientists are trained, needs to continue its activities with this awareness. Research assistants form the core of the academy. Considering the academy as a pyramid, there are research assistants at the bottom of it. Although it seems important, a research assistant has basic duties. These basic duties include the execution of the administrative work of the unit, as well as the academic studies that the person continues for his own development. The selection of research assistants is also important, as they form the foundations of the academy. Because people who will start as research assistants are expected to be among those who will contribute to science in the future. Research assistants must be subjected to many evaluations when starting their profession. The characteristics they carry must be in accordance with the relevant units. Because they will take part in most of the academic and administrative affairs of the relevant unit. Therefore, the criteria to be considered in their selection are important. The starting point of the study was this importance.

Aimed to determine the importance ranges of the criteria affecting the selection by considering the research assistant selection problem, which is the backbone of the academy. In our study, there are criteria that are not included in the literature and were included in the study in line with expert opinions. For this reason, a contribution to the literature has been made. Regardless of the results of the study and the results of the study, it is expected that the criteria they will pay attention to in the research assistants they will choose for the relevant department are expected to shed light on the decision maker and make the decision-making process easier.

In order to determine the criteria to be used in the study , face-to-face interviews were conducted with three experts in the field and the qualifications they sought in the person to be recruited as a research assistant in management information systems were asked. First of all, the criteria of YÖK were asked, the experts did not find these criteria sufficient and said that there should be different specific criteria. By adding the criteria obtained in the literature review, experts were asked for their opinions again. Experts found some of these criteria insufficient and some unnecessary, and the list was eliminated and the current list used in the study was obtained. The list used in the study consists of criteria accepted by three experts . Finally, some criteria have been put forward for the evaluation of decision makers. These criteria are scientific competence (KM), ability to understand and explain (AAT), foreign language skills (YDB), having a critical perspective (EBAS), analytical thinking skills (ADB), work discipline (EA), technology knowledge (TB) , suitability for team spirit (TRU), being solution-oriented (COO), ability to communicate (HRM), ability to take risks and make decisions (RAKV), general appearance (DD), age (M) and experience (D ) Four criteria were determined.

The determined criteria were evaluated by experts working at seven different universities. When the criteria evaluated by the experts were examined, it was revealed that the most important criterion was the candidate's technological knowledge. TB criteria were followed by BY, ÇD, AAK, ADB, YDB, ÇOO, İKY, TRU, GG, D, RAKV, EBAS and Y criteria, respectively. TB, BY, EA, AAK and ADB criteria are higher than the others, and these five criteria constitute 56% of the total weight value. According to experts, the most important consideration when choosing a research assistant is TB, RA, EA, AAK and ADB, and the suitability of these criteria will positively affect other criteria. The weights of the criteria evaluated with the opinions of the experts are given in Figure 6.

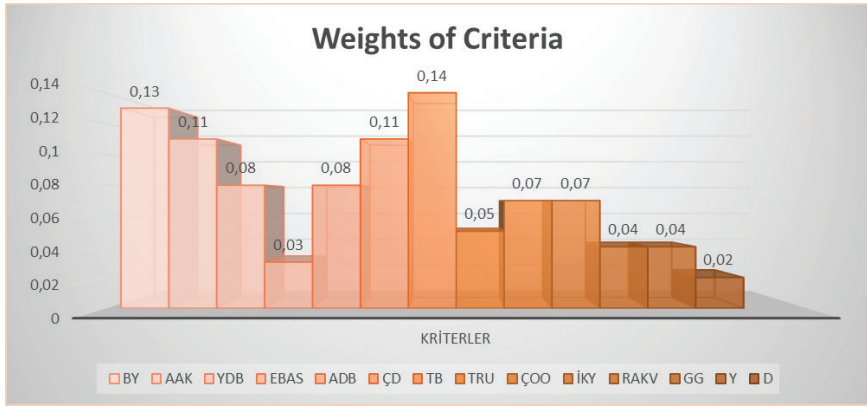

**Figure 6.** *Criterion Weights*

When the information in the literature and expert opinions are examined, one of the most important points in the selection of research assistant is the person's technology knowledge. The research assistant who will be preferred without paying attention to this feature will both contribute less to the relevant unit and the adaptation process will be longer. When the results of the related study are evaluated, it supports both the literature and the information obtained from the interviews with the experts. In other words, when choosing the research assistants to be recruited to the decision maker unit, they should subject them to a more specific evaluation. The criteria determined in subsequent studies can be evaluated with different decision-making methods, and the differences that may arise can be examined and the methods can be compared with each other.

## SOURCE

- Aksakal, E. and Dagdeviren, M. (2010). An Integrated Approach to Personnel Selection Problem with ANP and DEMATEL Methods. *Gazi University . Eng. Mime. Fac. der.*, 25(4), 905-913.
- Aytekin, A., Akgun, F. and Aydogan, H. (2021). Determination of Mobile Phone Selection of Bartın University Management Information Systems Students Using Analytical Hierarchical Process and Fuzzy Analytical Hierarchical Process Methods. From the Individual to Artificial Intelligence, Socioeconomic and Cultural Studies, Academician Publishing House, Ankara.
- Bali, O. (2013). A MLKV Model with Fuzzy Dimensional Analysis and Fuzzy VIKOR: Personnel Selection Problem. *KHO Journal of Science* , 23(2), 125-149.
- Bali, O. and Gencer, C. (2005). AHP, Fuzzy AHP and Fuzzy Logic Instructor Selection for the Military Academy. [http://w3.gazi.edu.tr/~ctemel/bali&gencer\\_2005.pdf](http://w3.gazi.edu.tr/~ctemel/bali&gencer_2005.pdf) Access Date: 05.10.2022.
- Celikbilek , Y. (2018). Using Integrated Gray AHP–MOORA Approach for Personnel Selection: An Application on Manager Selection in Health Sector. *Alphanumeric Journal* , 6(1), 69-82.
- Dogan , A. & Onder , E. (2014). The Use of Multi-Criteria Decision Making Techniques in the Procurement and Selection of Human Resources and an Application. *Yaşar University E -Magazine*, 9 (34), 5796-5819. Retrieved from <https://dergipark.org.tr/pub/jyasar/issue/19148/203255>
- Gibney, R., & Shang, J. (2007). Decision making in academia : A case of the dean selection process . *Mathematics and computer Modeling* , 46(7-8), 1030-1040.
- Higher Education Information Management System Instructor Statistics <https://istatistik.yok.gov.tr/> Access Date: 01.10.2022
- İbicioğlu , H. and Ünal, Ö. F. (2014). Competency Based Human Resources Manager Selection with Analytical Hierarchy Process. *Atatürk University Journal of Economics and Administrative Sciences*, 28(4), 55-78.
- Kabak, M. and Kazançoğlu, Y. (2012). Teacher Selection with Fuzzy Analytical Hierarchy Method and an Application. *Afyon Kocatepe University Journal of FEAS* , 14(1), 95-111.
- Kwiesielewicz, M., Van Uden, E. (2004). inconsistent Andean Contradictory Judgments In Pairwise Comparison Method In The Ahh . *Computers&Operations Research* , Vol:31 Issue:1.
- Koyuncu, O. and Ozcan, M. (2014). Comparison of Analytical Hierarchical Process and TOPSIS Methods in Personnel Selection Process: An Application in Automotive Industry. *Hacettepe University Economic and Administrative Journal of the Faculty of Sciences* , 32(2), 195-218.
- Kose, E., Aplak, H. S. and Kabak M. (2013). A Gray System Theory-Based Integrated Approach for Personnel Selection, *Aegean Academic Perspective* , 13(4), 461-471.



- Liberatore , MJ And Nydick RL (2008), — The analytics hierarchy Process in Medical and health Resort Decision Making : A Literature Review I, *European Journal of Operations Research* , 189 (1), 194-207.
- Öneren, M., Arar, T. & Çelebioğlu, ES (2017). Strengthening the Foundation of the Academy: Determining the Factors in Recruitment of Research Assistants with AHP. *Journal of Aksaray University Faculty of Economics and Administrative Sciences*, 9 (1), 39-50. Retrieved from <http://aksarayıibd.aksaray.edu.tr/tr/pub/issue/34899/391837>
- Öztürk, F., & Kaya, GK (2020). Personnel Selection with Fuzzy Vikor : Application in Automotive Sub-Industry. *Gazi University Journal of Science*, 8(1), 94-108.
- Rouyendegh, BD & Erkan, T. E. (2013). An Application of the Fuzzy ELECTRE Method for academic staff selection. *Human Factors and Ergonomics in Manufacturing & Service Industries* , 23(2), 107-115.
- Saaty , TL (1980). “ the analytics hierarchy Process ”, McGraw-Hill International Book Company , New York P. 54.
- Saaty , TL (1990), How to Make a Decision . *European Journal of Operations Research* , 48(1), 9-26.
- Saaty , TL(2008). Decision making with the analytics hierarchy Process.Int . *J. Services Sciences* , 1(1), 83-98.
- Vatansever, K. & Öncel, M. (2014). An Implementation of Integrated Multi-Criteria Decision making Techniques for academic staff Recruitment . *Journal of Management, Marketing and Logistics* , 1(2), 111-125 .
- Punniyamoorthy, M., Ponnusamy, M. And Lakshmi G. (2012), —A Combined Application of Structural Equation Modeling (SEM) And analytics hierarchy Process (AHP) in Supplier Selection , I Benchmarking : An International Journal , 19 (1), 70-92.
- Timor, M., Analytical hierarchy process, *Turkmen Bookstore*, (2011), 98-116.
- Tüminçin , F. (2016). *Building a Decision Support System with Analytical Hierarchical Process (AHP): Application in a Manufacturing Enterprise* ( Master’s Thesis , Bartın University, Institute of Social Sciences).
- Yorulmaz, M. & Yanık, A. (2021). Determination of Management Criteria for Ship Captains. *Balkan and Near East Journal of Social Sciences* 7(2), 53-66.
- Zolfani, S.H., Rezaeiniya, N., Aghdaie, MH, & Zavadskas, EK (2012). Quality Control Manager Selection Based on AHPCOPRAS-G Methods : A Case in Iran. *Economics Research-Ekonomiska Istraživanja* , 10(2), 72-86.
- Wu , F. (2010), — Housing Environment Preference of Young Consumers in Guangzhou , China : Using The analytics hierarchy Process I *Property Management*, 28 (3), 174 – 192.



“

## Chapter 20

**ORIENTALISM(S) IN TWO EMPIRES:  
COMPARING VASILY VERESHCHAGIN  
AND OSMAN HAMDİ BEY**

*Fatma COŞKUNER<sup>1\*</sup>*

”

---

<sup>1</sup> Dr. Fatma Coşkuner, Medipol University, Department of Fine Arts, Design and Architecture.

The second half of the nineteenth century witnessed the reform and disciplining of “backward” peripheries of multi-ethnic and multi-religious empires. In this period, imperial governments in Russia and the Ottoman empire utilized painting and later photography to revive their political image as powerful empires. This was one of the important reasons for the spread of Orientalism, and the Russian and Ottoman empires were no exception. As a result of the changes occurring in the imperial paradigm during the nineteenth century, which was due to an increased focus on nationalist modernization, the reform and disciplining of “backward” peripheries of multi-ethnic and multi-religious states led to the birth of Orientalism in the Russian and Ottoman Empires. This article aims to explore the ties between images of both empires’ Oriental subjects and the construction of the nations’ identities as imperial powers by looking at the works of two artists, the Russian Vasily Vereshchagin (1842–1904) and the Ottoman Osman Hamdi Bey (1842–1910). In discussing how Russian and Ottoman discourses were founded on the opposition of (their own) East and West, I intend to critically engage with the role that visual imagery played in the imperialist project. The study provides the first comparison of these artists in terms of their Orientalist approaches by discussing how Russian and Ottoman discourses were founded on the opposition of their own territorial Easts and Wests. Examining the works, they produced in the peripheries of their countries; I also reconstruct how these painters’ ethnographic visuality and its mirage were used to justify both empires’ *mission civilisatrice* in the late nineteenth century.

Tracking how constructed geographical boundaries are framed as provisional and discursive,<sup>1</sup> this study focuses on two selected time periods from each artist: Vereshchagin’s Turkestan years (1868–73) and his “ethnographic” visual productions, prepared for a commission of Governor General Konstantin von Kaufman (1818–82); and Osman Hamdi’s Baghdad period (1869–71), which occurred early in his career and was the result of his father’s decision to send him to this provincial location after his stay in Paris. I will also briefly mention the photographic collection of traditional Ottoman dress titled *Elbise-i Osmaniyye: Les costumes populaires de la Turquie*, which was commissioned by the Ottoman government on the occasion of the 1873 World Exposition in Vienna and prepared by Osman Hamdi and Marie de Launay. Because these two regions, Turkestan and Baghdad, can be labeled the “peripheries” and “backward” regions of the respective empires, they

---

1 For detailed analysis on how the spatial and cultural constructs of Orient and Occident were created see: Martin W. Lewis and Karen Wigen, *The Myth of Continents: A Critique of Metageography* (Berkeley: University of California Press, 1997).

feed both artists' Orientalist enthusiasm and their empires' civilizing missions. Through the contribution of their artworks to this process, Vereshchagin and Osman Hamdi Bey played a significant part in the successful creation of a Russian and Ottoman Orient, respectively. Their art produced "realist mystification" of peripheral regions: their efforts towards making available information about accessories and costumes, and their "timeless" depictions of life in these places open up another intriguing dimension of nineteenth-century Orientalist art. It should be emphasized here that, since Osman Hamdi and Vereshchagin were not "Western," but citizens of "Eastern" empires, some viewers might have understood their artistic perspectives to be a reliable albeit enhanced impression of reality. But to what extent was this reality constructed? What kind of impact has the "East" had on both empires' political development, their culture, and their mentality? What roles have the empires' peculiar geographical locations between East and West played in shaping their identities? Relating these questions with each other, this article maps the different types of orientalist exchanges that occurred in the cases of Vasily Vereshchagin and Osman Hamdi Bey.

### Vasily Vereshchagin: A Russian Orientalist<sup>2</sup>

After a career at the Military Academy and Naval school,

---

2 Since the disintegration of the Soviet Union, especially in the 2000s, scholars have been discussing the application of Orientalist theories and colonial forms of knowledge to art and culture of the Russian Empire. Nathaniel Knight presented the first extended engagement with Said's argument in the Russian fields: Nathaniel Knight, "Grigorev in Orenburg, 1851–1862: Russian Orientalism in the Service of Empire?" *Slavic Review*, 59 (2000)1; Vera Tolz, "Orientalism, Nationalism and Ethnic Diversity in Late Imperial Russia," *The Historical Journal*, 48 (2005) 1. The article generated a debate in *Kritika* among scholars in the Russian field—one of the few examples of historians discussing the applicability of Said's ideas to Russia: Adeeb Khalid, "Russian History and the Debate over Orientalism," in *Orientalism and Empire in Russia*, *Kritika*. Historical Studies 3, ed. Michael David-Fox, Peter Holquist and Alexander Martin (Bloomington: Indiana University, 2006), 23–31; Nathaniel Knight, "On Russian Orientalism: A Response to Adeeb Khalid," in *ibid.*, 37; Maria Todorova, "Does Russian Orientalism Have a Russian Soul?" in *ibid.*, 48–49; Vera Tolz, "European, National and (anti) Imperial: The Formation of Academic Oriental Studies in Late Tsarist and Early Soviet Russia," in *ibid.*, 107–34. However, scholars have different opinions on the applicability of Said's *Orientalism* to the Russian context. This is because in contrast to the maritime colonial powers, the building of the Russian empire through territorial conquest was contiguous to its own borders; there were no geographical barriers between Russia's metropolis and the Eurasian East. For the examination of the colonial encounters in the Russian Empire in a broad comparative framework see: Daniel R. Brower and Edward J. Lazzarini, ed., *Russia's Orient: Imperial Borderlands and Peoples, 1700–1917* (Bloomington: Indiana University Press, 1997); Mark Bassin, "Russia between Europe and Asia: The Ideological Construction of Geographical Space," *Slavic Review*, 50 (1991) 1; Mark Bassin, "Imperial Space/National Space—Siberia on the Cognitive Map of 19<sup>th</sup> Century," *Geschichte und Gesellschaft*, 28 (2002) 3; Mark Bassin, *Imperial Visions Nationalist Imagination and Geographical Expansion in the Russian Far East, 1840–1865*. Cambridge Studies in Historical Geography (Cambridge/New York: Cambridge University Press, 1999); Robert Geraci, *Window on the East National and Imperial Identities in Late Tsarist Russia*. (Ithaca: Cornell University Press, 2001); David Schimmelpenninck van der Oye, *Toward the Rising Sun: Russian Ideologies of Empire and the Path to War with Japan* (DeKalb, Illinois: Northern Illinois University Press, 2001).

Vereshchagin enrolled in the *Imperatorskaya Akademiya Khudozhestv* [Imperial Academy of Arts] in 1860, the year of the students' rebellion against the Academy. This revolt marked the emancipation of Russian art from the outdated criteria of the Academy of Arts, whose staff would no longer determine artistic tastes and serve as the major center of Russian art education. As a result of these developments, Vereshchagin abandoned the Academy, its classical training, and the capital, St. Petersburg, and went to develop his artistic skills elsewhere. He first spent three years in Paris at the atelier of the famous Orientalist painter Jean-Léon Gérôme (1824–1904) and then went to work independently as an Orientalist in the Caucasus, a region that had served as a source of creative inspiration for many Russian artists and writers before.

In 1868, the artist traveled to Turkestan on a special commission of the governor-general Konstantin von Kaufman, who provided Vereshchagin complete freedom. He created his own images of the new territory to be later published in a special album. This famous *Turkestansky albom*<sup>3</sup> [Turkestan Album] (1868–73) of the artist that includes over 200 drawings, 108 small and 19 monumental oil paintings, can be thematically divided into ethnic portrait types, landscapes and architectural sights, Orientalist genre paintings, and battle scenes.<sup>4</sup> From this diverse album, we can see how selected genre paintings (excluding battle scenes) engaged with ethnographical classification.

In the album, Vereshchagin made a clear ethnic classification without generalized scientific types. He divided locals according to their levels of social development and depicted them differently according to this division: while the upper class in this hierarchy was represented with more detailed facial drawings, he chose to minimize the facial features of the nomads, the lowest level of this caste system.<sup>5</sup> He also eroticized the nomads comparatively more than the upper class, through their costumes and accessories. His carefully produced portraits included representatives of all ethnicities and social classes found in the region. With its people, nature, culture, and economy, the series provided an

3 Recent years have witnessed significant research on Russia's colonial rule in Central Asia, which provides a valuable context for the analysis of Vereshchagin's *Turkestansky albom* [Turkestan Album] (1868–73). See, for instance, Alexander Morrison, *Russian Rule in Samarkand, 1868–1910: A Comparison with British India* (Oxford/ New York: Oxford University Press, 2008); Jeff Sahadeo, *Russian Colonial Society in Tashkent: 1865–1923* (Bloomington: Indiana University Press, 2007); Robert Crews, *For Prophet and Tsar: Islam and Empire in Russia and Central Asia* (Cambridge, Mass.: Harvard University Press, 2006); Daniel R. Brower, *Turkestan and the Fate of the Russian Empire* (London, New York: Routledge Curzon, 2003).

4 David Schimmelpennick van der Oye, "Vasilii V. Vereshchagin's Canvases of Central Asian Conquest," *Cahiers d'Asie centrale* 17/18 (2009), 179–209.

5 Natasha Medvedev, "The Contradictions in Vereshchagin's Turkestan Series: Visualizing the Russian Empire and its Others" (PhD diss., University of California, 2009), 24–25, accessed 2016, ProQuest Dissertations & Theses.

informative idea about many facets of Turkestan's life. The scale of the images varied from general sketches and an objective capturing of the ethnic costumes to highly detailed drawings and distinct, often respectful, portraits of specific individuals. Russia's identity as an empire was in part produced by extraordinary efforts to categorize Central Asian peoples and customs as "Others", underscoring the necessity and historic inevitability of Russia's *mission civilisatrice* in the region. In its classification system and pictorial details, Vereshchagin's *Turkestan Album* can be this ideological project.

The primary purpose of Vereshchagin's commission, however, was to take part in General Kaufman's effort for ethnographic knowledge. The people are depicted as bust portraits with a particular focus on the facial expressions. These portraits are very valuable not only for their artistic success but also for their documentary authenticity, and they became famous in Russia and beyond. In many of the portraits, particularly those produced toward the end of Vereshchagin's travels through Central Asia, the artist created psychologically expressive images, capturing the ethnic peculiarity of individual subjects, their character, and social standing.

Despite the humanizing details one can find in many of his paintings, his depictions in this album are consistent with certain racial and class prejudices. The artist tried to record every ethnic type, native or not, living in Turkestan. Besides the pictorial representations, his written descriptions reproduced racial distinctions and stereotypes. He clearly makes a hierarchical division between the settled and the nomads. Ethnographic analysis provided enough ground for defining the ethnic types, which in the eyes of colonial administrators exemplified the hierarchy of peoples in the region: pastoral nomads were usually called *kirgiz*, the townspeople usually *sart* or *tajik*, and peasants either *sart* or *uzbek*.<sup>6</sup>

Besides numerous facial drawings of ethnic types, Vereshchagin also produced depictions of celebrated architectural monuments in a very detailed way and small-scale ethnographic paintings portraying single figures or small groups set against a background. For instance, four exemplary scenes from 1870's Tashkent focus on poverty as one of the major social problem in Central Asia and also explore the subculture of the dervishes: *Nishchiye v Samarkande* [Beggars in Samarkand], *Politiki v opiumnoy lavchonke* [Politicians in an Opium Den], *Dervishi v prazdnichnykh naryadakh* [Dervishes in Festive Clothes], and *Khor dervishey, prosyashchikh milostynyu* [Chorus of Dervishes Begging].<sup>7</sup>

6 Brower, *Turkestan and the Fate of the Russian Empire*, 53.

7 *Nishchiye v Samarkande* [Beggars in Samarkand], 1869–70, oil on canvas, 51.8 x 38.1 cm, State Tretyakov Gallery, Moscow, inv. 1917; *Politiki v opiumnoy lavchonke* [Politicians in an

The artist paints the beggars with documentary accuracy, dressed in colorful local clothes, asking for charity, or singing and idly talking among themselves. Special attention to detail is shown in the closed eyes and vacant faces drugged on opium of several of the figures.

Unlike many of his European counterparts, Vereshchagin personally witnessed the Eastern scenes that he painted, and this is perhaps why we do not find strongly stereotyped or sensationalized racial imagery in the Turkestan album. His work was his biography: Vereshchagin portrayed the streets, commerce, poverty, violence, crime, and architecture—what life in the Orient was really like. It was not a revisionist account based on perception and prejudice (not always), but the journey of his life. His engagement with the historically sensitive production of critical ethnographic knowledge challenged race and ethnicity as forms of exoticism in a medium of Orientalism and field of misrepresentation.<sup>8</sup> In particular, the Turkestan album, with its authentic details of architecture and clothing, served to create moral context that justified the Russian Empire's war of colonial conquest.

### Osman Hamdi Bey and His Role in Ottoman Orientalism

In the last few decades, the debates on the relationship between the Ottoman imperial center and the peripheral provinces within a colonial framework have opened a new critical window into Ottoman history.<sup>9</sup> The second part of this essay examines how the Ottomans

---

Opium Den], 1870, oil on canvas, 67.8 x 47.1 cm, State Tretyakov Gallery, Moscow, inv. 1913; *Dervishi v prazdnichnykh naryadakh* [Dervishes in Festive Clothes], 1870, oil on canvas, 72 x 47.5 cm, State Tretyakov Gallery, Moscow, inv. 1915; *Khor dervishey, prosyashchikh milostynyu* [Chorus of Dervishes Begging], 1869–70, oil on canvas, 71.7 x 49.6 cm, State Tretyakov Gallery, Moscow, inv. 1916. I am grateful to Marina Vasilyevna Ivanova from Tretyakov Gallery for providing the information on Vereshchagin's paintings.

8 I mean by forms of exoticism the Orientalist paintings' common points within the colonial context that were indicated by Linda Nochlin in her famous article. Natasha Medvedev makes a careful comparison between Gérôme and Vereshchagin in terms of Nochlin's three points: "the absence of a sense of history," "the absence of a tell-tale presence of Western man," "realist mystification" and mentions that Vereshchagin's Orientalism was rather different from that of Gérôme. For further information see: Natasha Medvedev, "The Contradictions in Vereshchagin's Turkestan Series: Visualizing the Russian Empire and its Others" (PhD diss., University of California, 2009), 28–31, accessed 2016, ProQuest Dissertations & Theses and Linda Nochlin, "The Imaginary Orient," *Art in America*, 71/5 (May 1983): 118–131.

9 I would like to mention some of the central figures in this debate and the rich terminology they invented. Apart from "Ottoman Orientalism" we also have "Orientalism alla turca" as it is used by Christoph Herzog and Raoul Motika; the "Ottoman civilizing mission" in Christoph Herzog's "Nineteenth-century Baghdad through Ottoman eyes"; the "Ottoman man's burden" and "modern Ottoman imperialism" by Ussama Makdisi; Selim Deringil's terms of "borrowed colonialism" and the "Ottoman colonial project;" and "colonial Ottomanism" used by Thomas Kühn to describe the same phenomenon in his study on Yemen. Christoph Herzog and Raoul Motika. "Orientalism Alla Turca: Late 19<sup>th</sup> / Early 20<sup>th</sup> Century Ottoman Voyages into the Muslim Outback," *Die Welt des Islams*, 40 (2000) 2: 139–195; Selim Deringil, "They Live in a State of Nomadism and Savagery: The Late Ottoman Empire and the Post-Colonial Debate," *Comparative Studies in Society and History*, 45 (April 2003): 311–342; Ussama Makdisi, "Ottoman Orientalism," *American Historical Review*, 107 (2002), 3: 768–796; Thomas Kühn.



represented their own Orient through the close analysis of Osman Hamdi as an Ottoman intellectual/bureaucrat and painter. Ottoman Orientalism discredited Western representations of Ottoman indolence by contrasting Ottoman modernity with the unreformed and stagnant landscape of the empire. In effect, it “de-orientalized the empire by orientalizing it.”<sup>10</sup>

By casting the Ottoman Empire as the progenitor of the Enlightenment ideal, capable of its own Renaissance, Ottoman reformers articulated a notion of the “Ottoman man’s burden”<sup>11</sup> toward its subject populations, who would have to be disciplined and reformed before the Ottoman Empire could firmly establish itself as a civilized power. In order to overcome the permanent distance between the Empire and its past, artists, scholars, intellectuals, and, in some cases, even the Sultan himself, utilized specific representative techniques to reconnect and glorified events from the Ottoman and Islamic past, and to make these events visible for nineteenth-century emotional Romantic consumers who desired to see the Ottoman political image of a powerful empire. In this respect, Osman Hamdi Bey, one of the earliest artistic figures in the non-western world to define his creative standpoint through a complex engagement with the European Orientalist tradition, was seeking to create a new dialogue with the Ottoman-Islamist past and identity through the idea of the Orient.

Osman Hamdi’s Baghdad years, which cover 1869–71, were very influential for his career in creating a domesticated vision of the Orient. Furthermore, the artist was also well informed about the late Ottoman agendas related to self-identification and self-projection. During his long stay in Paris, he, just like Vereshchagin, visited and studied in the ateliers of Jean-Léon Gérôme and Gustave Boulanger (1824–88), and he would produce various paintings in the Orientalist manner throughout his career.<sup>12</sup> However, separated from the prejudiced and discriminatory discourses about the East that were generally accepted, Osman Hamdi’s use of the Orientalism genre as an instrument was effective to deliver a clear alternative message informed by a larger cultural and ideological agenda. The Ottoman artist first took and then

---

“Shaping and Reshaping Colonial Ottomanism: Contesting Boundaries of Difference and Integration in Ottoman Yemen”, *Comparative Studies of South Asia, Africa and the Middle East*, 27 (2007), 2: 315–331.

10 Makdisi, “Ottoman Orientalism,” 773.

11 Makdisi used the term of famous British poet and novelist, Rudyard Kipling, *White Man’s Burden* to describe the Ottoman situation. Makdisi, “Ottoman Orientalism,” 782.

12 In his article, Ahmet Ersoy also defines the Orientalist painting as “ethnographic,” and mentions that during the second half of the 19<sup>th</sup> century Europeans mentioned these two words alternatively. Ahmet Ersoy, “A Sartorial Tribute to Late Tanzimat Ottomanism: The Elbise-i Osmaniye Album,” *Muqarnas* 20 (2003): 198.

manipulated his European artistic skills of looking in order to construct what he held to be “objective” scenes of an accepted native and original Ottoman-Islamic past.

For instance, the set of paintings called *Bağdat'tan Manzara* [View of Bagdad]<sup>13</sup> clearly demonstrates how a young cosmopolitan Ottoman artist was able to represent the empire’s peripheries and celebrate Ottoman cultural heritage by using the language of a Western academic painting style. Osman Hamdi’s paintings can be interpreted as part of a larger movement of redefining cultural patrimony. In general, Osman Hamdi Bey’s historical genre paintings contain selected architectural decor and figures dressed in local costumes and shown fulfilling their historical duty. As Ahmet Ersoy highlights, as a director of the Imperial Museum, an exposition commissary for the Vienna Exposition, and the co-author of an ethnographic costume album, Osman Hamdi Bey was very well aware of the “technologies of material display.”<sup>14</sup> He successfully combined the figurative posture (in most cases, the gesture in these figures “recalls mannequins displaying rare ethnographic specimens in a museum”<sup>15</sup>) with authentic decorations.<sup>16</sup> So, for nineteenth-century bourgeois customers seeking accurate material representation, his paintings offered a rich display of crafts, traditional artifacts, fine costumes, and rare materials from various time periods and geographies. The paintings of Osman Hamdi may thus “be considered among the early indicators of a nascent commodity culture (in the modern European sense, of course) among the Ottoman upper classes, as well as of the initial critical efforts to reroute this culture to local resources through the legitimizing power of history.”<sup>17</sup> In contrast to Osman Hamdi’s major Orientalist works, the *Baghdad series*<sup>18</sup> does not contain any human figures. The paintings rather represent the area and the architectural monuments (with small local figures) in an accurate way. During his Baghdad years, Osman Hamdi also produced ethnographic facial drawings that depict the local people with detailed expressions using a bust format close

---

13 *Bağdat'ta Sitti Zübeyde Türbesi I* [View of Bagdad: Sitti Zübeyde Tomb I], 1870, watercolor on paper, private collection; *Bağdat'ta Sitti Zübeyde Türbesi II* [View of Bagdad: Sitti Zübeyde Tomb II], 1884, oil on canvas, 59 x 119 cm, private collection; *Bağdat'tan Manzara* [View of Bagdad], 1870, watercolor on paper, private collection.

14 Ahmet Ersoy, “Osman Hamdi Bey and the Historiophile Mood: Orientalist Vision and the Romantic Sense of the Past in the Late Ottoman Culture,” in *The Poetics and Politics of Place: Ottoman Istanbul and British Orientalism*, ed. Zeynep İnankur, Reina Lewis, and Mary Roberts (Istanbul: Pera Museum Publication, 2011), 151.

15 *Ibid.*, 150.

16 Ahmet Ersoy, *Architecture and the Late Ottoman Historical Imaginary: Reconfiguring the Architectural Past in a Modernizing Empire* (London: Ashgate, 2015), 114–15.

17 Ersoy, “A Sartorial Tribute to Late Tanzimat Ottomanism,” 199.

18 I am especially grateful to Raffi Portakal who allowed me to include some sample drawings from Osman Hamdi’s Bagdad years.

to Vereshchagin's.<sup>19</sup> As Eldem mentions, these drawings depict people whom Osman Hamdi probably saw during his voyage.<sup>20</sup> Specifically, he drew their head accessories with great detail and all of them are different from each other. The Arabs, Kurds, Chechens—anonymous locals as well as notable people—are included in this album. It became possible to represent the unusual diversity of local people with the fascinating memorials and architectural structures of ancient cultures in his drawings. Attributing these portraits as Orientalist may be incomplete and narrow; however, it is certain that the curiosity and enthusiasm for these traditional cultures shaped Osman Hamdi's Orientalist gaze, which would come to be more obvious in his future projects.<sup>21</sup> Hoping to construct a romantic dynastic Ottoman tradition, these images can be interpreted as a mirror that shows a realistic picture of Ottoman society.

In this context, I would like to briefly mention *Les costumes populaires de la Turquie*, prepared by Osman Hamdi and Marie de Launay for the 1873 Vienna Exposition. It was designed to illuminate the ethnographic diversity of a multi-cultured, multi-ethnic empire and presented a detailed typological documentation of Ottoman dress by bringing together subjects representing the regional, ethnic, social, and religious components of the imperial unity.<sup>22</sup> This project presented for first time to the public such a wide panorama of the different cultures, ethnicities, and nationalities living together in the Ottoman Empire. In this album the local costumes were used as an essential vehicle in enhancing the reality of a remote and imaginary past, most of which seem to be stylized and exoticized versions of the traditional garments of the Arab provinces.<sup>23</sup> By showing all of the local costumes from every region of the empire, this project tried to emphasize the power of the Ottoman Empire as a multi-ethnic composition under one strong Sultan.

19 In his book, *Osman Hamdi Bey ve İzlenimler 1869–1875*, Eldem mentions that there are fifteen facial drawings and three large paintings related to his Baghdad years. According to his findings, these portraits were made by the artist during his voyage. Most of them are local scenes except the portrait of Midhat Efendi who was a friend of Osman Hamdi and was depicted as “My dear and voyage friend Midhat Efendi.” Ethem Eldem, *Osman Hamdi Bey ve İzlenimler 1869–1875* (Istanbul: Doğan Kitap, 2015), 23.

20 Eldem, *Osman Hamdi Bey ve İzlenimler*, 27.

21 Eldem, *Osman Hamdi Bey ve İzlenimler*, 27.

22 In recent years there have been many studies about this costume album. For recent ones please see: Ahmet Ersoy, *Architecture and the Late Ottoman Historical Imaginary: Reconfiguring the Architectural Past in a Modernizing Empire* (London: Ashgate, 2015); Ahmet Ersoy, “A Sartorial Tribute to Late Tanzimat Ottomanism: The Elbise-i Osmaniyye Album,” *Muqarnas* 20 (2003), 187–207; Ethem Eldem, “Elbise-yi Osmaniye’yi Tekrar Ele Almak I,” *Toplumsal Tarih*, 248 (August 2014): 26–35; Eldem, “Elbise-yi Osmaniye’yi Tekrar Ele Almak II,” *Toplumsal Tarih*, 250 (October 2014):46–51; Eldem, “Elbise-yi Osmaniye’yi Tekrar Ele Almak III,” *Toplumsal Tarih*, 252 (December 2014): 72–77; Eldem, “Elbise-yi Osmaniye’yi Tekrar Ele Almak IV,” *Toplumsal Tarih*, 253 (January 2015): 42–49.

23 The album is organized into three main sections with twenty-two subdivisions: the European Territories, the Aegean/Mediterranean Islands, and the Asian/African Territories. I mention only the Arabian parts in this article.

Promoting cultural authenticity within the medium of costume, Osman Hamdi Bey tried to create a peaceful *mission civilisatrice* fed by imperial notions of geographic hierarchy. He participated in the advertising of the Ottoman Empire's image abroad, albeit through a strange mixture of Orientalism, anthropology, and Ottoman image making, by undertaking the publication of *Les costumes populaires de la Turquie*.

### Conclusion

In this study, I explored how the Russian and Ottoman discourses (as Eastern empires) founded on the opposition of (their own) East and West are not an airy European fantasy, but created body of theory and practice, through which both of these empires and their colonized subjects used to perceive themselves and to constitute themselves on the international stage. The time period discussed in this article was an era when the two empires were trying to re-position themselves in the world arena. In the unique situations of Turkestan and the Arab provinces as colonies, the mission to enlighten and civilize those people was justified by the cultural/artistic policies of both empires.

According to Vereshchagin's agenda, the Orientalist genre was used to demonstrate the barbarity of natives and in what degree they needed the progressive Russian influence. By reinforcing Orientalist stereotypes, his paintings act as vehicles of imperialist ideology. Like Osman Hamdi Bey, he characterized the "Oriental other" within the empire, but he was distinctive in that his paintings also encompassed the topic of the reality and legitimacy of imperialist war. Specifically, Vereshchagin's first-hand experience of the wars in the Central Asian territories inspired some of his Turkestan paintings. But, in the Ottoman case, there was no war against the Arabian people. They were an integral part of the empire and remained so until the First World War.

In the Ottoman case, Osman Hamdi Bey interpreted Ottoman modernization through the indication of Ottoman cultural difference from the West. In his earlier paintings, he used the Orientalist genre in a more ethnographic manner, as a tool to provide a message informed by a larger cultural and ideological agenda. His costume project situated the Ottoman state's distinctive cultural and historical background within the context of a homogenizing modernity. However, by constituting the various popular costumes of the empire "as integral components of Ottoman tradition,"<sup>24</sup> he was trying to link this ethnographic project to a bigger Ottoman *mission civilisatrice*, to civilize backward peripheries. Besides this mission, by mobilizing all corners of the Empire in a grand project, he was trying to demonstrate "the control and authority of the centralized state, as well

---

24 Makdisi, "Ottoman Orientalism," 786.

as...creating a sense of cohesion among the diverse inhabitants of the loose-jointed empire.”<sup>25</sup>

Vereshchagin and Osman Hamdi both came originally from Eastern empires and successfully created their own Orient throughout their ethnographic studies. They used art as a mode of dialogue (cultural, gendered, religious, etc.) between the Orient and Occident. Although they gave an impression of a genuine Oriental atmosphere, their works are on the whole examples of a constructed reality. By engaging in a dialogue with and sometimes even fighting with the dominant Western Orientalist ideologies, both artists used Orientalism to serve their own Oriental locations and people. It is important to mention that as citizens of Eastern empires, Vereshchagin and Osman Hamdi Bey both were already orientalized by the Western powers’ understanding of world geography before they took part in orientalizing their own empires. Some of their paintings showed strong similarities not only in subject matter but also in compositional structure, specific iconographical motifs, and the overall striking effect. Although they represented different parts of the Orient and their experiences of peripheral lands occurred in very different conditions, both artists created depictions of these places as participatory observers; they were not “peaceful” Orientalist traveler artists of the nineteenth-century who were culturally detached from the scenes they witnessed. Osman Hamdi and Vereshchagin sought for greater faithfulness to their own impressions of what they saw, whilst also paying considerable attention to social and political realities in the East.

---

25 Ersoy, “A Sartorial Tribute to Late Tanzimat Ottomanism,” 188. Ersoy also elaborates how the Vienna Exposition of 1873 was an opportunity for the “Eastern” empires to demonstrate their ethnographic varieties.





1. Osman Hamdi Bey, *Çeçen İsmail* [Chechen Ismail], pencil on paper, 1869.  
Collection of Raffi Portakal.



2. Osman Hamdi Bey, *Şeyh Hasan* [Sheikh Hasan], pencil on paper, 1869.  
Collection of Raffi Portakal.





3. Vasily Vereshchagin, *Dervishes in Festive Clothes*, 72 x 47.5 cm, oil on canvas, 1870. State Tretyakov Gallery, Moscow, inv. 1915.



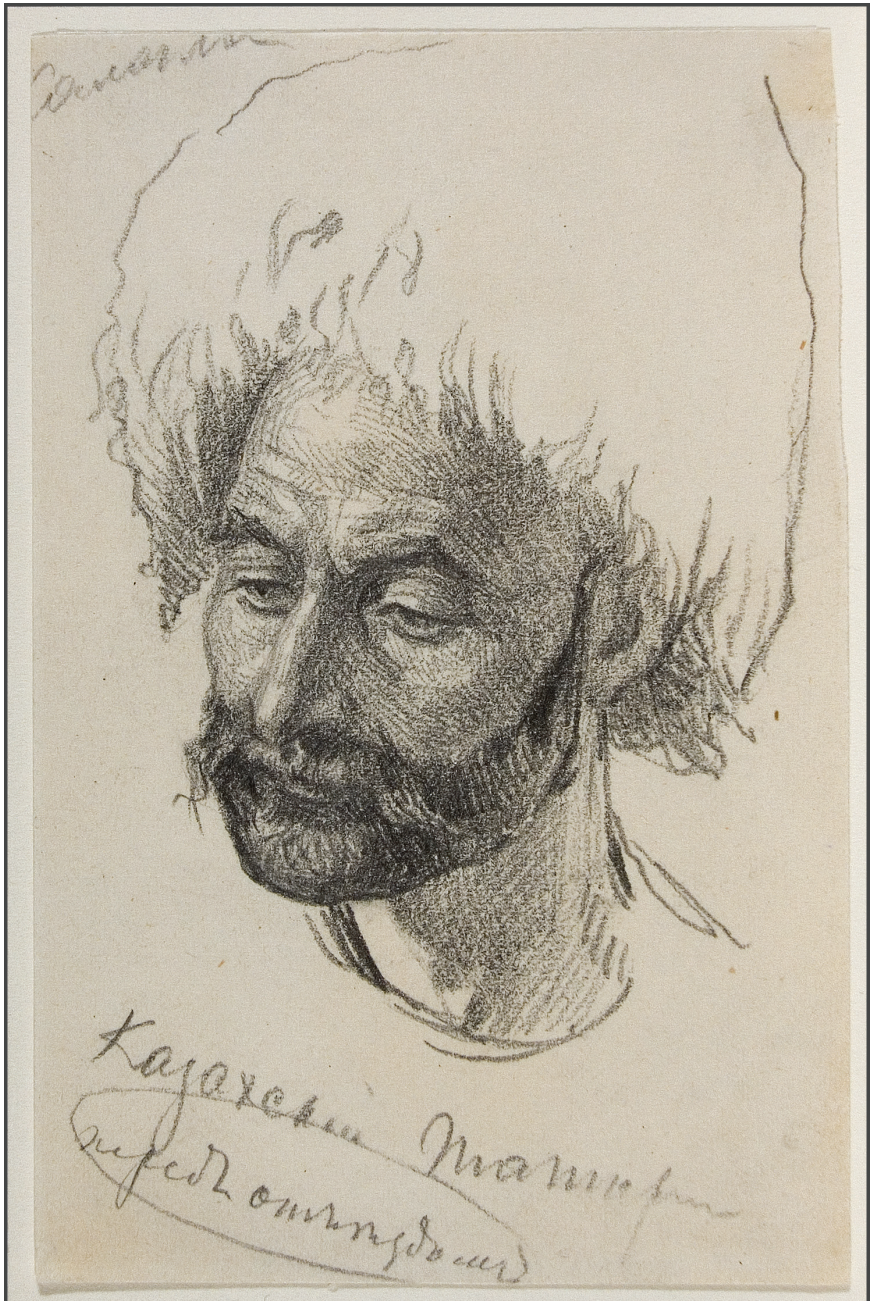

4. Vasily Vereshchagin, *Kazakh Tartar*, 10.3 x 6.6 cm, pencil on paper, 1865.  
State Tretyakov Gallery, Moscow, inv. 2151.





5. Vasily Vereshchagin, *Young Tartar Woman in a National Headwear*, 10.4 x 6.7 cm, pencil on paper, 1865, State Tretyakov Gallery, Moscow, inv. 2176

“

## Chapter 21

**BETWEEN MYTH AND HISTORY:  
REFLECTIONS OF THE EUROPEAN  
BATTLE PAINTINGS IN NINETEENTH-  
CENTURY OTTOMAN IMPERIAL  
IMAGERY<sup>1</sup>**

*Fatma COŞKUNER<sup>2\*</sup>*

”

---

1 This paper was presented at 14<sup>th</sup> Annual Graduate Symposium in Nineteenth Century Art that took place 26 March, 2017 and received Dahesh Museum Art Prize for the Best Paper.

2 \* Dr. Fatma Coşkuner, Medipol University, Department of Fine Arts, Design and Architecture.

## Introduction

The nineteenth century was a significant period for the reinvention of history painting and the re-appearance of battle scenes as a military subgenre of history painting. While the neoclassical style effectively expressed the content of historical subjects in the late eighteenth century, changing audiences, expectations, and experiences required new approaches in the nineteenth century, a century that also witnessed the rise of a breed of historical consciousness expressed in all corners of European civilization. There was a real break, a true transformation in historical consciousness, between the later eighteenth and the early nineteenth century, shaped by the French Revolution and the legacy of the Napoleonic enterprise. This break is also related to Romanticism.<sup>1</sup> Historians of the Romantic era turned to history as a narrative that could present and recreate the past. At a time when the whole range of contemporary concerns with the past first became accessible to representation, this historical consciousness of the Romantic period thus initiated a new genre of history painting that would flourish in France, particularly during the Napoleonic period, and would continue into the nineteenth century. The way in which history was depicted was an attempt to create an illusion of visual heroics; but further, the past began to be appropriated for political purposes to reinforce the cultural and political myths of the moment.

With respect to following the fashion of illustrating history, the Ottoman Empire was no exception. The second half of the nineteenth century, especially the reign of Sultan Abdülaziz (r. 1861–1876), witnessed tremendous changes in Ottoman history, culture, and art.<sup>2</sup> The increasing rapprochement between the Ottoman Empire and Western Europe deserves some attention here for it illuminates how the Sultan attempted to create and display a record of history and grandeur of the Ottoman nation. In 1867, Abdülaziz undertook a journey to Western Europe, and because it was the first such voyage of a sultan in the history of the Ottoman Empire, it became a unique opportunity for the inhabitants

1 Stephen Bann, *Romanticism and the Rise of History* (New York: Twayne, 1995), 5.

2 The nineteenth century was a significant period in the Ottoman Empire during which social, economic, cultural, and political reforms took place. Although the discourse of reform in the Ottoman Empire was not itself new, this nineteenth-century reform was part of a wider culture of modernism. Within the context of these reforms, the new European modality of art entered Ottoman visual culture. The development of the European painting style in Ottoman art had a direct connection with the increasing diplomatic relations with Europe, which started with the circulation of ambassadors. Later, during the long nineteenth century, many European artists, musicians, and travelers came to the Ottoman Empire and disseminated knowledge that allowed local artists to emerge and that influenced the first few generations of these new, European-leaning artists in terms of style and thematic choices. For interaction between Europe and the Ottoman Empire, see Halil İnalçık, “Mutual Political and Cultural Influences between Europe and the Ottomans,” in *Ottoman Civilization 2*, ed. Halil İnalçık and Günsel Renda (Ankara: Ministry of Culture, 2004), 1048–1089; and Günsel Renda, “Europe and the Ottomans: Interactions in Art,” in İnalçık and Renda, *Ottoman Civilization 2*, 1090–1121.

of European capitals to see a ruler from the legendary Ottoman dynasty in real life.<sup>3</sup> At the same time, in Paris, London and Vienna the Sultan had the chance to visit a number of sites where imperial and national might was displayed in glorious visual narratives. In her *Istanbul Exchanges: Ottomans, Orientalists, and Nineteenth-Century Visual Culture*, Mary Roberts mentions the effective relationship between the Sultan's voyage and his official battle-painting commissions.<sup>4</sup> Based on this idea, the present article began as an attempt to reveal in greater detail how the Sultan's experience in Paris and London may have influenced his own imperial imagery, particularly the possible artistic connections with the paintings he commissioned to Stanislaw Chlebowski (1835–1884).

According to Mary Roberts, who is particularly interested in the possible connections between European paintings and the battle scenes Abdülaziz would commission to Chlebowski, the Sultan had admired three specific collections. In Paris, his first stop, she notes that he visited the Invalides, where he saw the battle scenes painted by Parrocel for Louis XIV; he was also taken to Versailles, where he was shown the Galerie des Glaces and the Galerie des Batailles, the latter consisting of scenes recreating French military history, painted under Louis-Philippe. Finally, a few days later, when in London, he was hosted at the Houses of Parliament, where he admired Daniel Maclise's *Death of Nelson* and *Meeting of Wellington and Blücher*.<sup>5</sup>

A closer look at contemporary sources reveals a somewhat different picture, though.<sup>6</sup> Of the three visits and viewings, that of London is indeed documented as described.<sup>7</sup> Yet the Parisian events unfolded slightly differently according to the contemporary press. At the Invalides, which the Sultan visited on July 5 at 4 PM, he was first shown Napoleon's tomb,

---

3 In 1867, Emperor Napoleon III invited Sultan Abdülaziz to Paris for the inauguration ceremonies of the International Exposition. The Sultan then visited London as an invitee of the Queen. His last stop was Vienna. For detailed information about the Sultan's journey to Europe, see Taner Timur, "Sultan Abdülaziz'in Avrupa Seyahati – I," *Tarih ve Toplum* 11 (November 1984), 42–48; Taner Timur, "Sultan Abdülaziz'in Avrupa Seyahati – II," *Tarih ve Toplum* 12 (December 1984), 16–25; and Nihat Karaer, *Paris, Londra, Viyana: Abdülaziz'in Avrupa Seyahati* (Ankara: Phoenix Yayınevi, 2003).

4 I am indebted to Mary Roberts for sharing her ideas with me, allowing me to focus on nineteenth-century history painting in a comparative perspective. Mary Roberts, *Istanbul Exchanges: Ottomans, Orientalists, and Nineteenth-Century Visual Culture* (California: University of California Press, 2015), 52–53.

5 Roberts, *Istanbul Exchanges*, 52, 191.

6 I am indebted to Edhem Eldem, from Boğaziçi University, for having drawn my attention to the inconsistencies in this narrative and having provided me with the French and British press items analyzed in this article.

7 "The House of Lords," *Times* (London), 24 July, 1864. This short item explicitly mentions both paintings as having been "inspected" by the Sultan. It notes that Abdülaziz also saw "Mr. Herbert's fresco," meaning John Rogers Herbert's *King Lear Disinheriting Cordelia* (1850). The painting *The Death of Nelson* (1859–1861) depicts the demise of Admiral Nelson, who was shot while on the deck of the *HMS Victory* at the battle of Trafalgar in 1805. The fresco



“after which the Sultan examined the murals by Mr. Bénédicte Masson, who continues with a perseverance and talent worthy of the greatest praise, the great epic of our history.”<sup>8</sup> The article then had him review the *invalides*, the war veterans, lined up along the galleries of the main courtyard. While there is understandably no mention that he did *not* see Parrocel’s paintings, it might be construed that such detail about his viewing of Benedict Masson’s frescoes, which depicted the century of Charlemagne and were commissioned by Napoleon III, is evidence that this was all his artistic exposure at the Invalides.<sup>9</sup>

The Sultan’s tour of Versailles took place five days later, on July 10, on his way back from a visit to the military academy of Saint-Cyr. Not surprisingly, the cultural visit drew much less attention in the press than the military one; the most detailed account has only one paragraph about Versailles, but it has the advantage of being extremely precise:

The carriages drove the Sultan and his entourage to the palace of Versailles. The sovereign greatly admired the location and architecture of the monument. We quickly visited the great gallery, Louis XIV’s and Louis XV’s bedchambers, the council chamber, and some paintings of the museum. Then a lunch was served in the large hall overlooking the gardens, and from which we admired the magnificent terraces and all the natural splendors of this ancient residence of our kings.<sup>10</sup>

We do not know who E. Bauer, who signed this article, was, but his account is precise, probably since he seems to have been an eyewitness to the event.<sup>11</sup> When checked against the layout of the Château de Versailles, this information certainly makes sense. The “great gallery” (*Grande Galerie*) is the famous Hall of Mirrors (*Galerie des Glaces*), the huge (73

---

opposite, *The Meeting of Wellington and Blücher* (1859–1861), portrays the meeting of the Duke of Wellington and the Prussian Field Marshall Blücher before they defeated Napoleon at the Battle of Waterloo in 1815. For general information about British history-painting types that were most popular in the eighteenth and early nineteenth centuries, see Peter Cannon-Brooks, ed., *The Painted Word: British History Painting: 1750–1830* (Woodbridge, UK: Boydell, 1991) and for the changing role of battle painting in nineteenth-century Britain, see J. W. M. Hichberger, *Images of the Army: The Military in British Art, 1815–1914* (Manchester: Manchester University Press, 1988) and Peter Harrington, *British Artists and War: The Face of Battle in Paintings and Prints, 1700–1914* (London: Greenhill Books, 1993).

8 “Hier, à quatre heures, le sultan, accompagné de sa suite, a visité l’hôtel des Invalides. Au moment de son arrivée, il y avait encore une foule de visiteurs que l’Exposition y amène en si grand nombre. Le cortège, formé par la suite du sultan et l’état-major des Invalides, s’est rendu immédiatement au tombeau de l’Empereur. Le sultan a ensuite examiné les peintures murales de M. Bénédicte Masson, qui continue avec une persévérance et un talent digne des plus grands éloges, la grande épopée de notre histoire. Le siècle de Napoléon est presque entièrement terminé” (*La Presse* (Paris), 6 July, 1867). Translated by Edhem Eldem.

9 Abdülaziz’s visit to the Invalides is also mentioned in other newspapers, but with no significant detail. Only the *Petit Journal*, a day later, took up, word for word, the item published in *La Presse*.

10 E. Bauer, “Visite du sultan à Versailles et Saint-Cyr,” *La Presse*, 11 July, 1867.

11 Bauer uses the impersonal collective “on” to describe the event: “on a visité” ... “on a admiré.” This suggests that he himself was probably (though not necessarily) among the party.

m) hall that runs along practically the entire width of the palace's central section, overlooking the gardens. The barrel-vaulted ceiling of the Hall of Mirrors was decorated by Le Brun's paintings glorifying the reign of Louis XIV.<sup>12</sup> It communicates with Louis XIV's bedchamber (*Chambre du Roi*), which connects with the Council Chamber (*Salle du Conseil*), which in turn opens into another bedchamber, used by both Louis XV and XVI. In other words, Bauer's description corresponds to a compact and consistent itinerary of four rooms representing the quintessential nature of the château. It is not clear what the "large hall overlooking the gardens," where lunch was served, might have been; it may have been the Hall of War (*Salon de la Guerre*), adjoining the Hall of Mirrors and benefiting from a corner position, which gave it an outstanding view of the gardens.<sup>13</sup>

The important point to note is that this information makes it questionable whether Abdülaziz ever did get to see the *Galerie des Batailles*. This gallery is located along the western façade of the palace's south wing, at a walking distance of almost two hundred meters from the section visited by Sultan Abdülaziz. This, combined with Bauer's description of the event, casts serious doubts on the Sultan's alleged visit to the *Galerie des Batailles*. We will probably never know for sure which "paintings of the museum" he was shown.

My preliminary assumption, based on Roberts' work, had been that French military paintings, and more particularly the works exhibited in Versailles' *Galerie des Batailles*, had served as an inspiration for Abdülaziz's when he commissioned Chlebowski in order to form an Ottoman equivalent. However, thanks to my very thorough access to original files, further research revealed questions as to the veracity of Abdülaziz seeing the famed gallery or the Parrocel paintings during his Parisian stay. This, however, does not take away the interest of studying possible parallels between French military paintings and Abdülaziz's iconographic program. True, it would have been more sensational to place him directly in presence of these works; but now that we know he most likely did not see them, we should explore other forms of agency and inspiration that may have led to a similar result.

Despite the fact that he did not see the *Galerie des Batailles*, Abdülaziz's other visual experiences on the imperial visual legacies (both in France and Britain), his Ottomanist agenda, and the artistic background of his court painter might have enabled this visual project which has many

---

12 Marianne Cojannot-Le Blanc, "Figures of Narration in the Context of a Painted Cycle," in *Painting and Narrative in France, from Poussin to Gauguin*, ed. Peter Cooke and Nina Lübbren (London and New York: Routledge, 2016), 46.

13 Just to avoid any misunderstanding, it should be noted that the Hall of War contains martial allegories but no war paintings.

parallels with European examples.<sup>14</sup> This article aims to show how the Sultan and his court painter were involved in the collaborative project of a series of large-scale battle paintings following his voyage and exposure to European visual culture. These paintings communicate imperial ambitions that served the political interests of the Ottoman government. My study highlights the Sultan's desire to enhance the Ottoman Empire's stature in the international arena through pictorial narratives of the Empire's global rise, a new historical awareness that required new modes of expression. Large-scale history painting would be a perfect vehicle to express the greatness of the Ottoman state. Sultan Abdülaziz's own interest in history, combined with his awareness<sup>15</sup> and fighting occurring in the Balkan Peninsula, together with the Empire's gradual territorial losses, had greatly affected all people. How did the people of the Ottoman Empire, including the governors and the Sultan himself, conceptualize the war; and, more importantly, what images were available to contemporary society to create this mental construct? Believing and supporting the fact that the images might be conceived as a way to unify a splintered society, the Sultan, through his own commission, was trying to give visual form to the idea that national history could be redefined as the combined experience of the Empire's people at large. History was seen as a shared patrimony in which people from all segments of the Empire (regardless of their ethnicity) had a stake, and historical triumphant images, ranging from large-scale paintings to later small postcards, became an important part of the visual culture during the second half of the nineteenth-century Ottoman Empire.

### The Chlebowski Commission

One of the most influential pictorial statements of Ottoman imperial power was a cycle of battle paintings ordered from the Sultan's court painter Stanislaw Chlebowski between 1865 and 1872.<sup>16</sup> Chlebowski

14 Before he came to Istanbul, Chlebowski had a chance to visit several historical places while he was living in Paris and saw many paintings in the Parisian museums, galleries, and exhibitions. It is very probable that he was influenced by these paintings, specifically regarding compositional structure. For a detailed biography of the artist, see Agata Wójcik *Stanisław Chlebowski Nadworny Farbiarz Jego Sułtańskiej Mości* (Warsaw: Wydawnictwa Drugie, 2016), 31.

15 In his book, *Pride and Privilege*, Edhem Eldem explains how medals and decorations of the importance of history as a means of political came into the service of Ottoman/Islamic ideology, especially during the Aziz period. The image of the *Osmâni* order, its inscriptions, and the placement of the order on Osman Gazi's (the founder of the dynasty) sarcophagus by Abdülaziz in a ceremonial way reveal the historical consciousness that I would like to mention here in a clear and concrete way and propagated this new consciousness. Edhem Eldem, *Pride and Privilege: A History of Ottoman Orders, Medals and Decorations* (Istanbul: Ottoman Bank Archives and Research Center, 2004), 221.

16 The Sultan commissioned his own series from his court painter, Stanislaw Chlebowski, approximately two years before his voyage. In early 1864, Chlebowski had attended great military maneuvers at the Ottoman Camp of Levent Çiftliği, which he quickly reproduced on



was a Polish artist from a wealthy family in the southeastern part of Old Poland.<sup>17</sup> Between 1853 and 1859, he studied at the Saint Petersburg Academy of Arts, where he was trained in history painting.<sup>18</sup> In 1859, he was awarded a gold medal by the academy and received a six-year scholarship to study abroad.<sup>19</sup> For his further education, the young painter went on a journey across Europe and decided to stay in Paris, where he studied with Jean-Léon Gérôme.<sup>20</sup> At the invitation of Fuad Pasha and Sultan Abdülaziz,<sup>21</sup> he left Paris for Istanbul in 1864, where he stayed for twelve years. The Sultan prepared a studio<sup>22</sup> for him at Dolmabahçe

---

canvas at the beginning of 1865 and exhibited at Istanbul Galatasaray Barracks. Chlebowski's sketchbook in the National Museum in Warsaw shows that he made many detailed sketches during that military-camp visit. Sketchbook, 1864, Constantinople, Inv. No. Rys. Pol. 13005: 1/21, National Museum Warsaw. However, as indicated in one of the Ottoman archival sources, in 1869 the salary was paid to Chlebowski for his battle paintings. This document probably shows that Chlebowski had started to produce the battle painting cycle after 1867. Also, after the Sultan's voyage to Europe, his aspirations for modernizing the Ottoman state through visual narratives became more systematic. BOA, MB 145/132.

17 Tadeusz Majda, "European Artistic Tradition and Turkish Taste: Stanisław Chlebowski, The Court Painter of Abdülaziz," in *Sanatta Etkileşim/Interactions in Art*, ed. Zeynep Yasa Yaman (Ankara: Hacettepe Üniversitesi Yayınları, 2000), 176–177; and Wójcik, *Stanisław Chlebowski*, 31.

18 The sketchbook of the artist from his St. Petersburg Academy years, now located in the National Museum of Warsaw, shows that he was studying classical themes and figurative drawings of historical personae. Stanisław Chlebowski, *Szkicownik z czasu studiów w Akademii Sztuk Pięknych w Petersburgu 1853–1858* [Sketchbook at the Academy of Fine Arts in St. Petersburg], Inv. No. Rys. Pol. 13006:1/19, National Museum, Warsaw. I would like to mention my gratitude to Prof. Tadeusz Majda for facilitating my access to all necessary sources and discussing the artist and his collaborative works with the Sultan during my internship at the National Museum of Warsaw. Several historical paintings from the pre-Constantinople period prove that Chlebowski was familiar with the huge history-painting genre: Stanisław Chlebowski, *Joan of Arc in English Prison*, 1864, oil on canvas, 176x200 cm, Barrois Museum, Bar-le-Duc; Stanisław Chlebowski, *Tsar Peter I and His Court*, 1858, oil on canvas, 113x176 cm, Russian State Museum, St. Petersburg; Stanisław Chlebowski, *Young Bossuet Preaching in the House of Rambouillet*, 1856, oil on canvas, 93x130 cm, Tretyakov Gallery, Moscow.

19 Wójcik, *Stanisław Chlebowski*, 32.

20 His relationship with Gérôme was very important for his career, and he never lost his contact with the French master. After the Paris years, they also met in Istanbul, where Chlebowski asked his advice on paintings he was currently working on. They also visited other cities of the Ottoman Empire and worked together in some historical places such as at the Green Mosque in Bursa. After his Istanbul experience, Chlebowski returned to Paris and for this new period of his life, Gérôme was also very helpful in introducing Chlebowski to art circles. In the Krakow Jagiellonian Library, a set of their letters shows the intimate relationship between Chlebowski and his teacher Gérôme. BJ Przyb. 237–04, Chlebowski Papers, Jagiellonian Library, Krakow. Concerning his relationship with Gérôme, see Agata Wójcik, "Jean-Léon Gérôme and Stanisław Chlebowski: The Story of a Friendship," *RHA Journal* 14 (December 2010).

21 Actually, he was first invited by the Grand Vizier Fuad Pasha when they were in a military camp together. The Warsaw sketchbook shows that he was first invited by Fuad Pasha to draw the military units from the camp mentioned above. Both Mary Roberts and Agata Wójcik wrote that Fuad Pasha first invited him. Mary Roberts affirms that after the Fuad Pasha commission, he was invited by Sultan Abdülaziz. Roberts, *Istanbul Exchanges*, 40.

22 By examining the Ottoman archival sources, Cengiz Göncü gives detailed information about the artist's studio [*Resim Odası*] (an artist studio located in Dolmabahçe Palace and dedicated to the artists working for the palace officially) and also provides the original sources for Chlebowski's salary and the kinds of materials used for his paintings. Cengiz Göncü, "Osmanlı Sarayında Resim Sanatının Himayesinin Simgesi Olarak Resim Odası ve Görev Alan Sanatçılar," *Milli Saraylar* 9 (2012): 263–277.

Palace. After the Sultan's dethronement in 1876, Chlebowski returned to Paris and continued to produce Orientalist-genre scenes that met the Romantic tastes of nineteenth-century bourgeois consumers.

Chlebowski made the most of the historical-painting commission he received during his stay in Istanbul.<sup>23</sup> The battle-painting cycle, whose topics were determined by the Sultan, was meant as a historical narrative emphasizing the expansion and defense of the Empire's European borders and representing significant moments in the earliest phase of the Ottoman colonial conquest of the Balkan region. Intended for the walls of the Sultan's new residences on the Bosphorus, the Dolmabahçe, Çırağan, and Beylerbeyi palaces, these large-scale paintings celebrated Ottoman martial glory and were meant to impress those who visited the Sultan's palaces. Adopting David Cannadine's<sup>24</sup> concept of "Ornamentalism," Mary Roberts has characterized the Sultan's way of engagement with visual culture as part of "Ottoman statecraft."<sup>25</sup> The new palaces, as well as the battle paintings that decorated them, were part of this Ornamentalist project.

The Chlebowski cycle comprises twenty-six paintings, which, today, are divided between the Military Museum and the National Palaces' Painting Museum in Istanbul.<sup>26</sup> Ten of the paintings depict the heroism of specific rulers on the battlefield, in which generalized battle scenes set the stage for the commanders, usually represented with a small escort of military aids. Eighteen paintings of the cycle focus on Ottoman–Habsburg conflicts in the Balkan region, a region that was of crucial importance to the Ottomans in the second half of the nineteenth century, when their territorial losses in this region increased sharply. Two paintings depict the capture of Baghdad under Murad IV, in 1639. This campaign had a very important symbolic meaning as it ended the ongoing fight between the Ottomans and Safavids and confirmed the longevity of the Ottoman presence in this territory. Four paintings in the series represent the Ottomans' defensive

---

23 Chlebowski stayed in Istanbul between 1864 and 1876. During that time, he also visited Paris. However, he must have been in Istanbul in September 1864 because the photograph, now in the Jagiellonian Library, that Chlebowski sent to his uncle shows its date and place as September 27, 1864, Istanbul. Portrait of Stanislaw Chlebowski, 27 September 1864, BJ Przyb. 239–04: 1, Chlebowski Papers, Jagiellonian Library, Krakow.

24 Discussing architectural style, ceremonial display, royal travels, and the distribution of honors, David Cannadine highlights the "dignified" side of the empire and "ornamental" mode of the statecraft. David Cannadine, *Ornamentalism: How the British Saw Their Empire* (New York: Oxford University Press, 2001), 122.

25 Roberts, *Istanbul Exchanges*, 47.

26 From these twenty-six, only two are signed, and the others are labeled "Chlebowski School." However, İlkey Karatepe, from the Military Museum, notes the stylistic and compositional similarities between the two signed and nine unsigned ones. İlkey Karatepe, *Askeri Müze Resim Koleksiyonu* (Istanbul: Askeri Müze ve Kültür Sitesi Komutanlığı, 2011), 332–59. Also, by studying the Sultan's sketches and calligraphic inscriptions in Krakow, Mary Roberts attributes four of the paintings to Chlebowski. Roberts, *Istanbul Exchanges*, 192.

battles against the Greek rebels in the 1820s, the only paintings in the cycle that depict moments from nineteenth-century Ottoman history. The importance given to the Greek War of Independence (begun in 1821) reflects the Sultan's attempt to highlight his imperial policies that served to protect the territorial integrity of the Ottoman Empire from the nationalist movements within it. The Greek War of Independence was a dismal failure for the Ottoman army and there was little to celebrate in terms of paintings, although there were four scenes produced because this was particularly important for the Ottomans in the nineteenth century, given that the Greek War of Independence, which started in the Peloponnese in 1821, was the first and most prominent of the nationalist movements that threatened the territorial integrity of the Ottoman Empire.<sup>27</sup> The emotional and dramatic interpretations of the Greek War of Independence inspired several other palace commissions during the reigns of Sultan Abdülaziz and Sultan Abdülhamid II (r. 1876–1909).<sup>28</sup> In this respect, the paintings reflect the concept of Ottomanism,<sup>29</sup> which directed the management of the Empire following the proclamation of the nineteenth-century reform program called the *Tanzimat*. The *Tanzimat* aimed to unite all citizens within the framework of a common empire ideal regardless of ethnicity or religious origins, and Chlebowski's monumental canvases convey the ethos of empire fostered by the *Tanzimat*.

Important Models: The Galerie des Batailles in Versailles and the Royal Gallery in Westminster

The brainchild of King Louis-Philippe (r. 1830–1848), the Galerie des Batailles is an enormous, windowless space located on the second floor of the Palace of Versailles' southern wing. A skylight provides natural light for its thirty-three large, grand-scale battle paintings, twenty-nine of which were newly commissioned by Louis-Philippe.<sup>30</sup> They represent

---

27 Roberts, *Istanbul Exchanges*, 66.

28 The Italian artists Alberto Pasini and Fausto Zonaro continued to be commissioned to represent moments from the glorious history of the Ottoman Empire and contemporary military achievements. Although Pasini's four-painting series depicting the Ottoman-Greek War in Crete (*The Assault by the Ottoman Cavalry, The Cretan War, Bombing of the Fortress, The Greco-Ottoman War*) was iconographically different from those of Chlebowski's—in terms of royal patronage (being created for Sultan Abdülaziz) and theme selection, they showed strong similarities with the previous examples. The official court painter of Sultan Abdülhamid II, Fausto Zonaro, also depicted this moment from the Turkish-Greek War (*Battle of Domokos*).

29 For further information regarding Ottomanism, see Selçuk Akşin Somel, "Osmanlı Reform Çağında Osmanlılık Düşüncesi 1839-1913," in *Modern Türkiye'de Siyasi Düşünce Cilt 1: Tanzimat ve Meşrutiyet'in Birikimi* ed. Murat Belge (Istanbul: İletişim Yayınları, 2001); and Hasan Kayalı, *Jön Türkler ve Araplar: Osmanlılık, Erken Arap Milliyetçiliği ve İslamcılık, 1908–1918* (Istanbul: Tarih Vakfı Yurt Yayınları, 1998). During the long reign of Sultan Abdülhamid II (r. 1876–1909) Ottomanism took a more pronounced Muslim inflection, with pan-Islamism being promoted.

30 On aspects of Louis-Philippe's Musée Historique, see Claire Constans, *Versailles : La Galerie des Batailles* (Beirut and Paris : Led Editions Khayat, 1984); and Laurent Gervereau

the most illustrious examples of French military genius, from the Battle of Tolbiac in 496 to Napoleon's victory at Wagram in 1809. The gallery is an opportunity for visitors to appreciate French power throughout the centuries; it is also a space in which battle painting proclaims its supremacy as the pictorial domain of emperors and kings.<sup>31</sup>

The battles for the project were selected carefully.<sup>32</sup> Although they cover a historical period that ranges from medieval to modern times, as Michael Marrinan emphasizes, seven of the thirty-three scenes are dedicated to the post-Revolutionary period and five of these to the era of Napoleon; this shows that in Louis-Philippe's historiography of France, the Napoleonic wars had a privileged place.<sup>33</sup> The defense of Christianity and national unity is one of the most popular themes. Battles that involved and therefore could be used to celebrate a coalition between different socio-economic levels of France's population are also popular. Louis-Philippe's creation of the Musée Historique de Versailles was, in large part, motivated by his desire to unify a fractured France by emphasizing that all parties—Orléanists, republicans, Bonapartists, and legitimists had a shared history, as reflected in the visual discourse of the museum. The Galerie des Batailles, displaying a historic series of battle paintings in which France had won major triumphs, was a big part of that project. The museum's motto, *A toutes les gloires de la France* (to all the glories of France), was intended to make the French feel a sense of patriotic ownership in the battles shown.

Formally speaking, the battle paintings in the Galerie des Batailles, commissioned for the most part in the 1830s and 1840s, shun the documentary-style "Lejeunian mode"<sup>34</sup> that had become popular during the Imperial period and the Restoration. This mode provided for a general overview of the military episode, encompassing as much detail of the battlefield and the chaos of combat as possible.<sup>35</sup> Louis-François Lejeune

---

and Claire Constans, *Le Musée révélé: L'histoire de la France au Château de Versailles* (Paris: Robert Laffont, 2005).

31 Michael Marrinan, *Painting Politics for Louis-Philippe: Art and Ideology in Orleanist France* (New Haven and London: Yale University Press, 1988), 164.

32 For a discussion of each image and a political interpretation of the entire program, see Thomas Gaehtgens, *Versailles, de la résidence royale au Musée historique: La Galerie des Batailles dans le Musée historique de Louis-Philippe* (Paris: Albin Michel, 1984), 113–255.

33 Marrinan, *Painting Politics for Louis-Philippe*, 164.

34 Derin Tanyol's term "Lejeunian mode" refers to the paintings of Louis-François Lejeune, which depict the whole battle in tiny proportions within a topographical view. Derin Tanyol, "Napoleonic Painting from Gros to Delaroche: A Study in History Minor" (Ph.D. diss., The City University of New York, 1999), 303.

35 The war paintings that filled the post-revolutionary salons had in common their monumental proportions and themes of military victory in foreign lands. However, stylistically these paintings differed tremendously, given the range of artists who received commissions and their artistic backgrounds. In her article, Susan Siegfried classifies two modes, or "new rhetorics," of military painting produced under Napoleon: the affective mode, represented by Gros's *The Battle of Nazareth*, and the documentary mode, exemplified by Louis-François Lejeune's *The Battle*

(1775–1848) turned to past examples of official topographical military scenes and reworked their conventions to fit artistic needs. What is missing in his painting is a foreground setting for a king and his commanders. The paintings in the Galerie des Batailles, by contrast, highlight the leaders of glorious battles in French history. They depict action at the very front edge of the painting. These two main kinds of battle paintings, the heroic or “affective” mode as designated by Siegfried,<sup>36</sup> and the topographic or “documentary” mode, essentially co-existed during the nineteenth century. However, most of the paintings in the Galerie des Batailles are in the heroic mode, which was favored by rulers and governments because it emphasized glory, victory, and acts of courage to illustrate heroic leadership.

The specific visual choices performed by British examples were perfectly synchronized with the requirements of the nineteenth-century battle-painting fashion. The Fine Art Commission, established in 1841, with Prince Albert as chairman, was in charge of developing and implementing a program of painting and freestanding sculpture for the new Palace of Westminster, which was rebuilt after the great Parliament fire in 1834. Over and above the need for decoration, it was hoped that the vast building would provide ample opportunity for state support for contemporary art. This was something that had not happened before on such a scale. The Fine Art Commission assigned a period or subject from British history for each area of the palace. The Royal Gallery (like the Galerie des Batailles) was assigned the subject of Britain at war, and eventually was home to gilded sculptures of warrior kings and queens. The walls of the gallery are decorated by two enormous water-glass paintings by Daniel Maclise (1806–1870) depicting significant moments from the Napoleonic Wars: the death of Horatio Nelson at Trafalgar and the meeting of the Duke of Wellington and Field Marshall Blücher prior to the final defeat of Napoleon.

---

*of Marengo.* Siegfried, “Naked History,” 236. Siegfried also notes that the fact that he had been a soldier may explain Lejeune’s interest in documentary details. Besides the “documentary” and “affective” modes, another interpretation comes from Michael Marrinan. He describes two genres of history painting: one is the grand manner of history painting exemplified by François Gérard’s *Battle of Austerlitz*, while the other possesses a more illustrative approach, as shown in Horace Vernet’s Napoleonic battle-painting canvases. Michael Marrinan, “Historical Vision and the Writing of History at Louis-Philippe’s Versailles,” in *The Popularization of Images: Visual Culture under the July Monarchy*, ed. Petra ten-Doesschate Chu and Gabriel P. Weisberg (Princeton: Princeton University Press, 1994), 113–143.

<sup>36</sup> Siegfried analyzes what is the “affective mode” by examining Gros’s *Battle of Nazareth*. As she indicates, Gros sought to emphasize the new, democratic effect on the individual in his military paintings, which Siegfried categorizes as “affective” mode.” With its emphasis on a central action within the larger narrative and the heightening of dramatic effect through color and brushwork, Gros’s *Battle of Nazareth* changes the viewer’s point of view and allows for the close observation of individuals’ actions. Siegfried points out that this radical departure from past conventions and traditions in military painting was in response to an official discourse that represented and glorified the common soldier. Siegfried, “Naked History,” 236.

The Commission planned eighteen paintings for the Royal Gallery illustrating British military history; however, the two enormous wall paintings by Maclise were the only elements of this ambitious schemes to be completed. Being quite different from the French case, mid-nineteenth-century Britain had seen the successful curtailment of royal power at the hands of Parliament. However, designing a royal gallery at the newly erected Parliament building might have been a solution for this division. Thus, it was decided from the start that the paintings in the gallery would be a great machine for illustrating the stories of events revealing individual heroism (in the case of Wellington and Blücher) or sacrifice (the dramatic death of Admiral Nelson) and would offer a fair and constructive interpretation. The project was never completed, largely running out of steam after the death of Prince Albert in 1861.

### **Abdülaziz's Battle Painting Commission and the European Examples**

I would like to emphasize that what I am endeavoring to deal with here is open to discussion and reflects only a personal analysis of the narratives of selected paintings. Thus, my purpose is not to refute all possible connections among the three imperial visual imageries nor to accept them with complete confident confidence, but as a curious attempt of an art historian simply to sketch the logic of this parallel visuality as a first step toward understanding how battle painting was used as a powerful mechanism in representing and promoting history during the long nineteenth century. Indeed, there are many parts still to be explored, and further investigation is needed in areas such as the rise of nineteenth-century military painting in Europe, the concept of “hero” in these paintings, and the impact of war art on people’s attitudes to the empire and nationalism. Although it would be difficult to know exactly in what respect Sultan Abdülaziz was influenced by these imperial showcases, both ideologically and stylistically there are certain comparable aspects through the broader lens of the nineteenth-century military-painting genre.

Within the Chlebowski cycle, the two paintings (figs. 1, 2) depicting the Battle of Varna, both in the Military Museum in Istanbul, are the largest, as well as the earliest. The Battle of Varna occurred on November 10, 1444, near the Bulgarian Black Sea coast of Varna. The Ottoman army, commanded by Sultan Murad II (r. 1421–1451), defeated the Christian Crusade of the King of Poland and Hungary Władysław III, the last Christian campaign against the Ottoman Empire in the Late Middle Ages. The battle was a great Ottoman victory and sealed the fate of the Balkan territory and the Byzantine Empire. It assured the prestige and authority



necessary for the Ottoman dynasty to create an empire and prepared for the conquest of Constantinople.<sup>37</sup>

The two Varna paintings focus on the cavalry combat, as each work foregrounds an Ottoman commander on a running white horse, bedecked with colored tassels, battling the Crusaders. In the first one, victory is represented through visual symbols like the red Ottoman flag (in Ottoman Turkish called *tuğ*) carried high by those in pursuit of the group of Crusaders carrying the two-headed eagle standard. In the second painting, emphasizing the territorial conquest of Varna and the religious significance of the Muslim victory over the Christians, Chlebowski depicted the city's fortress and the green Ottoman standard displayed on the fortress walls.<sup>38</sup> In this painting, the red Ottoman *tuğ* appears again as a mark of Ottoman power. The main theme of Crusader defeat and Muslim victory is efficiently expressed through the forcing backward of the Crusader commander, whose sword slips from his hand. These two main figures represent the tragic face of the war.<sup>39</sup>

The Varna paintings call to mind Eugène Delacroix's *Battle of Taillebourg* (fig. 3) in the Galerie des Batailles. That painting shows King Louis IX riding a white horse, advancing on the retreating coalition of rebel and British forces. A common denominator in all three paintings is not only the main motif of a soldier on a white horse pursuing the enemy but also the significant use of emblems as well as architectural monuments (the Taillebourg Bridge in Delacroix's painting and, presumably, the Varna fortifications in the Varna paintings). This use of medieval architectural imagery in battle paintings helps to construct the viewer's experience of time and place.<sup>40</sup> All three paintings represented a new mode in history painting: no more historical representation through an allegoric machinery, rather a representation of any confined or precise act which then stood as most distinguished in the accomplishment of that event. Both artists isolated a fragment of the event and made this isolation visible by means of simple cropping: both physically, by the frame of the paintings, which cuts soldiers and horses on the left and the right, and

37 Halil İnalçık, *The Ottoman Empire: The Classical Age 1300–1600* (London: Phoenix Press, 2000), 21; Daniel Goffman, *The Ottoman Empire and Early Modern Europe* (Cambridge and New York: Cambridge University Press, 2002), 9.

38 In this painting, Chlebowski also depicted the Ottoman commander's use of the musket. In the course of these wars, the Ottomans were quick to adopt from their enemies the superior weapons of the West; the Ottomans used large cannons in the siege of Constantinople in 1422 and muskets at Varna in 1444. These paintings and the Sultan's suggestive preliminary sketches provide an Ottoman perspective of history that was collaboratively (re)created by Sultan Abdülaziz and his court artist Chlebowski.

39 Roberts, *Istanbul Exchanges*, 54–55; Karatepe, *Askeri Müze Resim Koleksiyonu*, 332, 336.

40 However, although we know that Chlebowski would have studied arms and costumes in the Ottoman Military Museum in Hagia Irene, the obvious anachronism in some of the weaponry in these paintings and European costume raises the question as to what historical resources were readily available to the artist and his patron. Roberts, *Istanbul Exchanges*, 192.

ideologically, focusing on a carefully selected event within a fragment of time, space, and action.

Besides, Louis-Philippe's commission of the *Battle of Taillebourg* celebrates King Louis IX's personal commitment to maintaining the integrity of the nation and the unification of the fragmented parts of the empire. This is the remarkable point of the painting. The battle fought by Louis is presented as a victory for the defense of the motherland and resembles the unity of the nation.<sup>41</sup> It is not possible to understand the Medieval French victories without St. Louis as writing or illustrating the Ottoman history without mentioning the battles of Varna. For the strategy of employing pictorial representations of past victories to "utilize" them as a specific vehicle to spread their current political ideologies, the Sultan was trying to establish a unifying Ottomanist ideology during the gradual military and territorial losses as a result of the independence movements of the Balkan nations. So, the narrative mechanism of these pictures catches the viewer in a process of understanding the simulative historical representation of the event.

If Delacroix's *Battle of Taillebourg* could have inspired Chlebowski's paintings of the *Battle of Varna*, another painting in the Galerie des Batailles may be connected to another painting by Chlebowski: *Sultan Mehmed III at the Battle of Eğri. Battle of Austerlitz* by François Gérard (1770–1837) was one of the largest and most important Napoleonic paintings in the Galerie des Batailles. The painting shows the presentation of the enemy standards to Napoleon by General Rapp. The general enters the painting from the left, on his galloping horse, to report the French victory to the Emperor, who is seated on his white horse right off-center. Both Napoleon and Rapp are riding white horses, whereas the Emperor's horse is at rest, Rapp's is shown in full gallop. Both men are surrounded by groups of soldiers, while in the foreground, one can distinguish a number of wounded and dead soldiers—but they are limited, kindly treated, and restricted to the shadows or margins of the frame.<sup>42</sup> By designing it to refer Napoleon's careful battle strategy, as Michale Marrinan successfully elaborates, "the picture's narrative unfolds from left to right, and orchestrates the viewer's experience to culminate on the resplendent equestrian figure of Bonaparte: at the far left, vestiges of the battle ... alternate with the arrival of captures banners; further toward the center – and riding in the same direction as our visual scan – General Rapp announces ... the troops of Tsar Alexander I have been routed ..."<sup>43</sup>

---

41 Gaechtgens, 148–152.

42 David O'Brien, *After the Revolution: Antoine-Jean Gros, Painting and Propaganda under Napoleon* (Philadelphia: Pennsylvania State University Press, 2004), 149–150.

43 Marrinan, "Historical Vision and the Writing of History at Louis-Philippe's Versailles," 126–129.



Chlebowski's *Sultan Mehmed III at the Battle of Eğri* is similar to Gérard's in style and iconography. The Sultan is mounted on a superb white steed receiving the good news of his victory against the Habsburgs, just as Napoleon receives General Rapp's report that the Imperial Guard, on Napoleon's order, has defeated the Russian troops of Alexander I's guard. This time, the narrative of the events was described from right to left, illustrating the Habsburg commanders bringing their standard before Sultan Mehmed III (1595–1603) and representing the Ottomans' symbolic victory of the Eğri Campaign in 1596. Mehmed III was the first sultan to personally command the army since Sultan Süleyman I (1520–1566), the Magnificent, thirty years earlier, so the Sultan's imperial image benefited from his participation in the campaign. This painting also shows the ruler off-center, depicting the calm but victorious equestrian figure of Mehmed III on the left of the painting. Chlebowski structured the picture's narrative energy, as in Gérard's arrangement, by illustrating the principal actor and his white horse in an intense way. Both paintings illustrate the grand manner of history painting in an "affective" mode, as well as the dramatic story of the battlefield: a collage of cadavers strewn across the foreground, destroyed weaponry, and striking expressions of consternation on the faces of defeated officers all serve to root the viewer with a corporeal fixity.

Given the significance of the Napoleonic wars in the Galerie des Batailles, it is not surprising that the British Empire selected two critically important battles from the same era, both important victories against Napoleon. Maclise's *The Meeting of Wellington and Blücher after the Battle of Waterloo* is at the front of this objective. Again, contrasting documented events, in topographic mode, Maclise created a grand manner of history painting in a very affective approach. In the center of the composition, the Duke of Wellington is shaking hands with his Prussian ally, General Blücher, directly in front of the sign of an inn, appropriately named "Belle Alliance." Wellington is mounted on his famous horse Copenhagen, and immediately beside him, to the right, are Lord Arthur Hill (the aide-de-camp who would deliver Wellington's victory message to London) and the generals. Blücher is also accompanied by his generals. The scene is dominated by the dead and wounded, men and horses from all regiments, emphasizing the tragedy of war rather than glorifying it. The artist focuses on a very critical stage of war: the meeting of the two commanders at the Battle of Waterloo, the meeting that signaled the end of the war. Waterloo is very important in British history for ending the Napoleonic invasion. This painting also reflects a new form of battle painting in which the incident replaced the all-embracing narrative panorama as in French and Ottoman examples.

Each example from the different imperial imageries has a number of common features: each represents the heroic mode of the grand manner of history painting by focusing on specific incidents vital to representing imperial victories. The portrayal of a collaborative battle strategy (rulers working with their major commanders and in strategic alliances) and the tragic face of the battlefield can be attributed as another common remarkable feature. Ideologically speaking, the subjects of the paintings were chosen carefully and represent the glorious past of each empire. They are not simply depicting triumphant memories, they are also displaying the battles as strategically important and as distinctive milestones in French, Ottoman, and British imperial historiographies.

## Conclusion

This comparative study is concerned with the way historical images in three different geographies were constructed, presented, and finally interpreted. The examples discussed in the article show that there seems to be a unique idea that the imperial policies during the nineteenth century helped to construct a national identity through visual culture. Each ensemble was commissioned to commemorate past victories and show how series of sacrifices and glorious facts tightened the national link. In terms of the specific cultural work performed by these paintings, they were part of a global visual program to be impressive to the visitors, and in terms of iconography, these paintings generated an enormous amount of material. The thematic selection was clear: these cycles represent battles or very specific military events where the French/British/Ottoman value is honored. As discussed in the first part of the article, the accuracy of sources is part of a broader methodological problem. But, it is a truth that Sultan Abdülaziz was very much influenced by these nineteenth-century visual programs and they played a very important role in his policy-making process.<sup>44</sup>

I would also like to mention the differences between each case. In the Chlebowski cycle, except for four paintings depicting the Greek War of Independence (1821–29), there is an emphasis on old glorious battles. The subjects of the paintings were carefully chosen to promote “Ottomanism.” The possible explanation for the rather recent battle paintings depicting the Greek War of Independence might recall those territorial losses as events not to be repeated. The reason may have been that it was not possible for the Sultan to depict recent achievements while the Ottoman Empire was gradually losing its territories. It is also important to consider

---

<sup>44</sup> Although one cannot date exactly Chlebowski’s paintings, as indicated in the financial documents of archives, this battle-painting commission started after 1867, most probably after his return from his voyage to Europe. So, this study is just a beginning and aims to integrate the Ottoman battle painting commission into a broader vogue in nineteenth-century Europe.

that, since the Chlebowski paintings were hanging in his private palaces, the Sultan did not have to deal with a public that expected a connection between the past and the present. By highlighting the grand moments of Ottoman history through visual art, Sultan Abdülaziz demonstrated to European visitors that the Ottoman Empire had long played a role in the international arena. At the same time, these paintings represented the sultanate as the great unifying force of the Empire.

In terms of spaces where such works were destined to appear, in the Ottoman case, they could not reach the level of an official museum or gallery like the Galerie des Batailles and Royal Westminster.<sup>45</sup> The Chlebowski paintings were mostly hung in the Sultan's private palaces (Dolmabahçe, Çırağan, and Beylerbeyi), where, one assumes, they were seen by members of the royal family or his administrative circle and European royal visitors, such as Empress Eugénie, hosted by Abdülaziz in the Beylerbeyi summer palace in 1869.<sup>46</sup> However, after his European trip, Sultan Abdülaziz thought to design a museum/place as a historical space where the narratives of history are told and retold. Hagia Irene, located in the first courtyard of Topkapı Palace, hosted an antique collection of the objects brought from all parts of the Empire. The similarities between the Ambras Gallery in Vienna and the collection there and the content of the Hagia Irene made it a suitable place for the imperial museum. Indeed, Hagia Irene officially took the name *Müze-i Hümâyûn* and opened as the first imperial museum of the Ottoman Empire shortly after Abdülaziz's trip to European capitals. Sultan Abdülaziz also took an active role in the decision-making process regarding which paintings would stay in the palace and which would be sent to the newly constituted museum. Newspapers<sup>47</sup> indicate that Sultan Aziz sent thirteen war/battle paintings first to the Military School and then the Military Museum. It is impossible to know which paintings precisely; yet, through a study of the visual politics of Sultan Abdülaziz, it would be ideologically more useful to display the Chlebowski commission rather than inserting it in a closed-palace environment, simply for the Sultan's artistic taste. This would offer the possibility of interpreting this commission and its space formation as an arena to construct political message.

Still, we cannot say that the Chlebowski commission was designed to recreate a social space in the manner of the Galerie des Batailles and the British Royal Gallery. These two European examples, by contrast,

45 Bilge Ar, "Aya İrini'nin Müze-i Hümâyûn Olarak Tahsis Ediliş Süreci ve Sultan Abdülaziz," in *Sultan Abdülaziz ve Dönemi: Sosyo-Kültürel ve Ekonomik Hayat: Proceedings of the Symposium in Ankara, December 12-13, 2013*, by Türk Tarih Kurumu (Ankara: Türk Tarih Kurumu, 2014), 51.

46 Chlebowski's drawing of Empress Eugénie, made during this visit, was published in the French journal *L'Illustration*.

47 *Basiret* (Istanbul), 24 Temmuz 1287; *Terakki* (Istanbul), 11 Ağustos 1871.

were part of a public place, containing references to ordinary citizens; the paintings could be seen by all Frenchmen and Britons. Their goal was to present a comprehensive pictorial history of the empires and show how far imperial policies went toward manipulating the mind of the average citizen through the narratives of visuality. Certainly, there was a common feeling, particularly in the nineteenth century, that paintings representing great military achievements might have a positive and inspiring impact on society and lead to social and moralistic improvement.

Situating the Chlebowski paintings within the context of Sultan Abdülaziz's travels in Europe and his self-presentation in widely circulated formal photographs, one begins to see them as the products of a new kind of Ottoman patronage. No longer content to passively adopt established European ideas and practices, Abdülaziz seemed eager to participate in the shifting expressive ways of the nineteenth century, including photography, world expositions, and the glorification of national history through pictorial narratives. To him, historical narratives of military victories must have seemed excellently suited to express his aspirations for consolidating and modernizing the Ottoman state, as these historical narratives helped to rebuild the Empire's stature on the international stage. The imperial interest in battle paintings was not limited to the reign of Abdülaziz: it continued during the reigns of the following sultans, and the Chlebowski commission played a very significant role in this continuation. Reproductions from the twenty-six battle paintings were published in the newspapers as postcards following the reign of Abdülaziz, proving the specific role of the Chlebowski commission over a long period and through the changing forms of artistic media including large history painting, popular prints, and the illustrated press. These reproductions show that this unique commission constitutes a milestone in the foundation of late-Ottoman imperial imagery, created between myth and history. As a consequence, it is clear that the unrealistic, quasi-cinematographic vision proposed by these paintings is what has strongly built our imagination up to this point. Accompanied by the historicizing fashion that prevails today, with its nostalgia for romanticism, this vision continues to infuse stereotypes of popular imagery, from illustrations of class books to comic strips and cinema.



1. Stanislaw Chlebowski, *Battle of Varna*, 1865, oil on canvas, 287x394 cm, Military Museum, Istanbul.



2. Stanislaw Chlebowski, *Battle of Varna*, 1865–72, oil on canvas, 287x394 cm, Military Museum, Istanbul.





3. Eugène Delacroix, *Battle of Taillebourg*, 1837, oil on canvas, 489x554 cm, Galerie des Batailles, Paris.



4. Stanislaw Chlebowski, *The First Siege of Vienna*, c. 1865–72, oil on canvas, 189 x 312 cm, Military Museum, Istanbul.





5. Stanislaw Chlebowski, *Sultan Mehmed III at the Battle of Eğri*, c. 1865–72, oil on canvas, 75.3 x 124.2 cm, Dolmabahçe Palace Painting Museum, Istanbul.



6. François Gérard, *Battle of Austerlitz*, 1810, oil on canvas, 510 x 958 cm, Galerie des Batailles, Paris.

“

## **Chapter 22**

**DRIVERS OF FINANCIAL  
DEVELOPMENT FOR RUSSIA AND  
CHINA AS NEW-STATE CAPITALISTIC  
AND EX-COMMUNIST COUNTRIES:  
PERESTROIKA OR GLASNOST?**

*Mehmet KUZU<sup>1</sup>*

”

---

<sup>1</sup> Assistant Professor Doctor, Bayburt University, Vocational School of Social Sciences; Department of Finance, Banking and Insurance, Department of Finance, mehmetkuzu86@gmail.com, ORCID:0000-0001-5354-4368

## 1. INTRODUCTION

The history of the modern world dates back 300 years ago. The most fundamental driving factor that changes the contemporary world is the developments at the intellectual and institutional level in the world political economy. Considering this historical process, we see two basic economic approaches emerge. In this context, while capitalism, which advocates all kinds of financial freedom, is the fundamental political economy paradigm of the liberal Western world, socialism, which supports a planned economy and rejects private property, has emerged as the primary political economy paradigm of the communist Eurasian world.

At the end of the Second World War, bipolar world order was established in which the USA as the hegemonic power of the capitalist world and the Soviet Union as the hegemonic power of the communist world was located in their centers in political and economic terms. In the post-war years, while continental Europe was incorporated into the US system, the People's Republic of China was incorporated into the Socialist world led by the Soviet Union. In this context, A cold war has begun between the United States and the Soviet Union.

While the USA followed a more aggressive cold war strategy until the President Nixon era, Republican Nixon's Secretary of State, Henry Kissinger, pursued a policy of encircling the Soviets by establishing an alliance system between the People's Republic of China and the USA.

As a result of this policy, the Soviet Union, which was isolated within the Eurasian alliance system, disintegrated in 1991. Gorbachev, the last president of the Soviet Union, aimed for a Russian Federation integrated into the global system by internationalizing the energy and raw material resources of the Soviets with the policy framework of perestroika, which means economic openness and glasnost, which means political exposure (Kurt, 2021: 1353-1354).

The People's Republic of China, another actor in the Eurasian world, started the Perestroika policy framework by initiating the economic and financial reform process by Deng Xiaoping in 1978. On the other hand, the Glasnost process progressed somewhat more slowly in the People's Republic of China than in Russia.

These two former communist countries have become more active with the increasing financial development in the global financial system with their economic and political openness policies. State capitalism is the basis of these political economy development frameworks. State capitalism; is a concept that expresses the financial systems in which the state manages the commercial units in a capitalist way with a centralized management

approach and the means of production are organized (Williams, 1985).

In this context, the aim of the study is; As a result of economic and political openness reform processes, it is to dynamically determine how much the financial development dynamics of the two former socialist countries, the Russian Federation and China, have historically been affected by the policies of perestroika and glasnost. For this purpose, the financial development index for China and Russia was chosen as the dependent variable, and the economic and political globalization variables were selected as the independent variables. The research method is the historical decomposition method derived from the VAR model. While economic globalization represents perestroika policies from these variables, The political globalization variable represents glasnost policies. The study's observation is the period between the end of the cold war and the Covid pandemic from 1991-2019 at an annual frequency. In other words, the aim of the research is; The purpose is to historically decompose the impact of perestroika and glasnost policies for China and Russia in terms of financial development in the transition period from communism to state capitalism.

## **2. LITERATURE REVIEW**

The number of experimental studies in the literature on the subject of the study is minimal. In this context, limited literature will be tried to be explained.

Smirnov (1992); After the 1991 presidential election, he developed an economic model that describes the effects of political conflict dynamics between central and local republics on perestroika policies in Russia at different levels.

Egreteau (2016), on the other hand, tried to apply the perestroika and glasnost policies, which are concept sets developed for Russia and China, in terms of political and political events in the Republic of Myanmar between 2010-2015. In other words, he analyzed these two concepts regarding political and economic events in Myanmar.

Baker (2017); The perestroika policies implemented in the 1980s during the Soviet era; In terms of parameters such as growth rate, foreign trade, and per capita national income, which reflect the economic performance of the Soviets, analysis has been obtained in terms of before and after the policy period. As a result, he concluded that perestroika policies in the 1980s in terms of economic openness were unsuccessful.

## **3. RESEARCH DESIGN, DATASET, AND METHOD**

This research; is to distinguish the historical effects of perestroika and glasnost policies as the determinants of financial development that China

and the Soviet Union showed in turning to the state capitalism paradigm.

Variables selected separately for China and Russia in the study; financial development index, economic globalization, and political globalization indices. While economic globalization represents perestroika policies, political globalization represents glasnost policies.

The observation range of the research is 1991-2019 at annual frequencies. There are two main criteria for choosing this range. The first is the ability to obtain data; the other represents the period between the end of the cold war and the Covid pandemic. (Table 1).

In the research, two different independent models will be estimated for China and Russia. The research method is the historical decomposition method derived from the VAR model. In addition, the stationarities of the variables were investigated with the Augmented Dickey-Fuller test.

With the help of the VAR model, back-and-forth connections and two-way interactions between the variables are determined. In contrast, the historical decomposition method derived from this model analyzes the parametric and shock effects of the independent variables on the dependent variable. (Sims, 1980), Burbidge, J. & Harrison, A. 1985)

**Table 1:** *Data Set*

<b>VARIABLE</b>	<b>CODE</b>	<b>SAMPLE PERIOD</b>	<b>FREQUENCY</b>	<b>SOURCE</b>
China Financial Development Index	CFDI	1991-2019	Annual	IMF FDI database
Russia Financial Development Index	RFDI	1991-2019	Annual	IMF FDI database
China Economic Globalization Index	CEGI	1991-2019	Annual	KOF Swiss Economic Institute
Russia Economic Globalization Index	REGI	1991-2019	Annual	KOF Swiss Economic Institute
China Political Globalization Index	CPGI	1991-2019	Annual	KOF Swiss Economic Institute
Russia Political Globalization Index	RPGI	1991-2019	Annual	KOF Swiss Economic Institute

**Figure 1: Graphs of Variables**

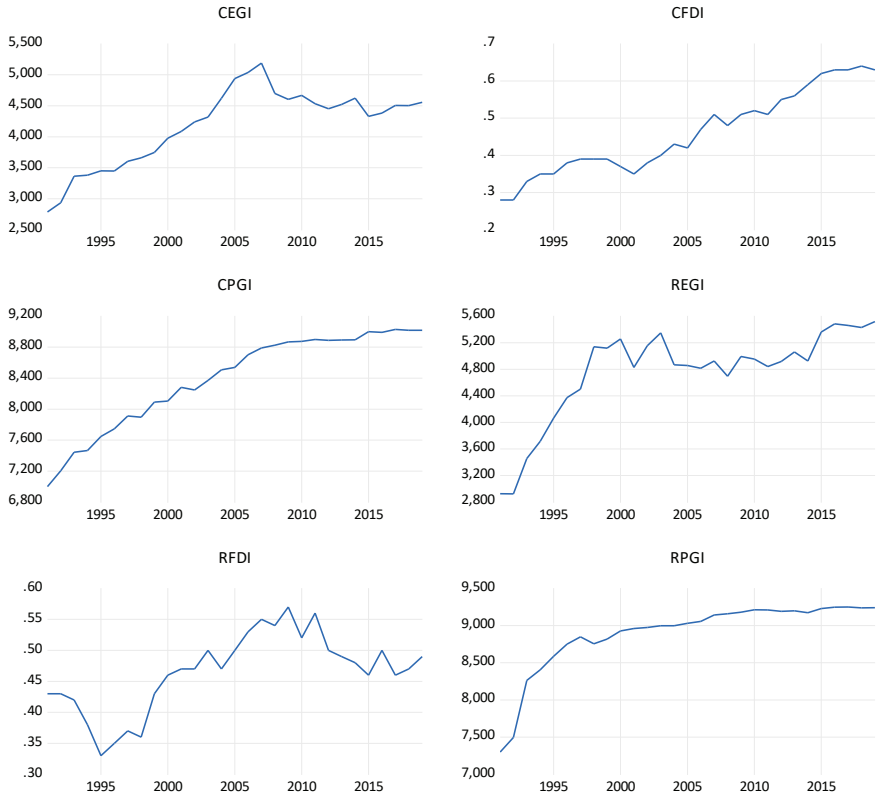

#### 4. RESEARCH RESULTS

In the study, firstly, the stability of the variables was examined with the help of the Augmented Dickey-Fuller test (Dickey and Fuller, 1979). It has been observed that the variables become stationary at the 1st difference level in terms of a constant term and non-trend models (See Table 2).

**Table 2: Unit Root Test Results**

UNIT ROOT TEST RESULTS TABLE (ADF)							
Null Hypothesis: the variable has a unit root							
	At Level						
		CEGI	CFDI	CPGI	REGI	RFDI	RPGI
With Constant	t-Statistic	-2.5576	-0.6546	-5.4667	-2.7683	-1.9867	-3.5782
	Prob.	0.1135	0.8423	0.0001	0.0757	0.2903	0.0147
		n0	n0	***	*	n0	**
With Constant & Trend	t-Statistic	-1.4102	-2.2793	-1.3083	-3.3235	-1.3483	-1.8800
	Prob.	0.8355	0.4308	0.8640	0.0874	0.8531	0.6320

		n0	n0	n0	*	n0	n0
Without Constant & Trend	t-Statistic	1.4855	2.7671	1.4683	1.5020	0.2435	1.6770
	Prob.	0.9625	0.9978	0.9609	0.9637	0.7493	0.9732
		n0	n0	n0	n0	n0	n0
	At First Difference						
		d(CEGI)	d(CFDI)	d(CPGI)	d(REGI)	d(RFDI)	d(RPGI)
With Constant	t-Statistic	-4.1760	-5.6635	-1.4312	-5.4961	-6.0136	-2.2443
	Prob.	0.0032	0.0001	0.5508	0.0001	0.0000	0.1978
		***	***	n0	***	***	n0
With Constant & Trend	t-Statistic	-4.6255	-5.5448	-9.3328	-6.0540	-5.8973	-3.6552
	Prob.	0.0052	0.0006	0.0000	0.0002	0.0003	0.0451
		***	***	***	***	***	**
Without Constant & Trend	t-Statistic	-3.9131	-1.7795	-1.7249	-4.8927	-6.1015	-3.1441
	Prob.	0.0004	0.0717	0.0799	0.0000	0.0000	0.0031
<b>Notes:</b>							
a: (*)Significant at the 10%; (**)Significant at the 5%; (***) Significant at the 1% and (no) Not Significant							
b: Lag Length based on AIC							
c: Probability based on MacKinnon's (1996) one-sided p-values.							

In the next step, the historical decomposition method derived from the VAR model was used to determine the level of explanation of the dependent variables historically by the independent variables. While conducting the research, two different VAR models were established for Russia and China at lag levels that ensure model stability in terms of the significance of the model results, based on the study of Balcilar (2018). In this context, the model stability condition is met since both models' inverse roots of the AR polynomial are in the unit circle at the 2nd lag level (See Figure 2). The representation of the models is presented in the equations

*Estimation Proc: MODEL FOR RUSSIA*

=====

*LS 1 2 RFDI REGI RPGI*

*VAR Model:*

=====

$$RFDI = C(1,1)*RFDI(-1) + C(1,2)*RFDI(-2) + C(1,3)*REGI(-1) + C(1,4)*REGI(-2) + C(1,5)*RPGI(-1) + C(1,6)*RPGI(-2) + C(1,7)$$

$$REGI = C(2,1)*RFDI(-1) + C(2,2)*RFDI(-2) + C(2,3)*REGI(-1) + C(2,4)*REGI(-2) + C(2,5)*RPGI(-1) + C(2,6)*RPGI(-2) + C(2,7)$$

$$RPGI = C(3,1)*RFDI(-1) + C(3,2)*RFDI(-2) + C(3,3)*REGI(-1) +$$



$$C(3,4)*REGI(-2) + C(3,5)*RPGI(-1) + C(3,6)*RPGI(-2) + C(3,7)$$

*VAR Model - Substituted Coefficients:*

=====

$$\begin{aligned} RFDI = & 0.548672879301*RFDI(-1) + 0.27213704397*RFDI(-2) \\ & + 2.59802031722e-05*REGI(-1) + 1.8546383778e-05*REGI(-2) \\ & - 6.85565916941e-05*RPGI(-1) + 2.4330726706e-05*RPGI(-2) + \\ & 0.271221334968 \end{aligned}$$

$$\begin{aligned} REGI = & - 1060.28856863*RFDI(-1) - 866.79417648*RFDI(-2) \\ & + 0.295207589517*REGI(-1) + 0.188394800087*REGI(-2) + \\ & 0.0272251798837*RPGI(-1) + 0.439163054101*RPGI(-2) - 650.655344975 \end{aligned}$$

$$\begin{aligned} RPGI = & 368.287012059*RFDI(-1) + 462.09902838*RFDI(-2) \\ & + 0.0224637304822*REGI(-1) + 0.00276967640392*REGI(-2) + \\ & 0.235144171849*RPGI(-1) + 0.249743878181*RPGI(-2) + 4179.16524046 \end{aligned}$$

*Estimation Proc: MODEL FOR CHINA*

=====

*LS 1 2 CFDI REGI RPGI*

*VAR Model:*

=====

$$CFDI = C(1,1)*CFDI(-1) + C(1,2)*CFDI(-2) + C(1,3)*REGI(-1) + C(1,4)*REGI(-2) + C(1,5)*RPGI(-1) + C(1,6)*RPGI(-2) + C(1,7)$$

$$REGI = C(2,1)*CFDI(-1) + C(2,2)*CFDI(-2) + C(2,3)*REGI(-1) + C(2,4)*REGI(-2) + C(2,5)*RPGI(-1) + C(2,6)*RPGI(-2) + C(2,7)$$

$$RPGI = C(3,1)*CFDI(-1) + C(3,2)*CFDI(-2) + C(3,3)*REGI(-1) + C(3,4)*REGI(-2) + C(3,5)*RPGI(-1) + C(3,6)*RPGI(-2) + C(3,7)$$

*VAR Model - Substituted Coefficients:*

=====

$$\begin{aligned} CFDI = & 0.841441496749*CFDI(-1) + 0.165782685534*CFDI(-2) \\ & - 2.7652251117e-05*REGI(-1) - 1.9401032681e-06*REGI(-2) \\ & - 1.42946748133e-05*RPGI(-1) + 3.36793263935e-05*RPGI(-2) - \\ & 0.0172403213947 \end{aligned}$$

$$REGI = 46.7284117424*CFDI(-1) + 495.465023855*CFDI(-2)$$

$$2) + 0.509343914423*REGI(-1) + 0.0570154256766*REGI(-2) - 0.330515032755*RPGI(-1) + 0.41788922426*RPGI(-2) + 1186.99174294$$

$$RPGI = 889.262020611*CFDI(-1) - 264.234621735*CFDI(-2) - 0.0749643104582*REGI(-1) + 0.0802721512033*REGI(-2) + 0.217300626349*RPGI(-1) + 0.231965023775*RPGI(-2) + 4693.60065842$$

**Figure 2:** AR Roots and Model Stability Condition Results

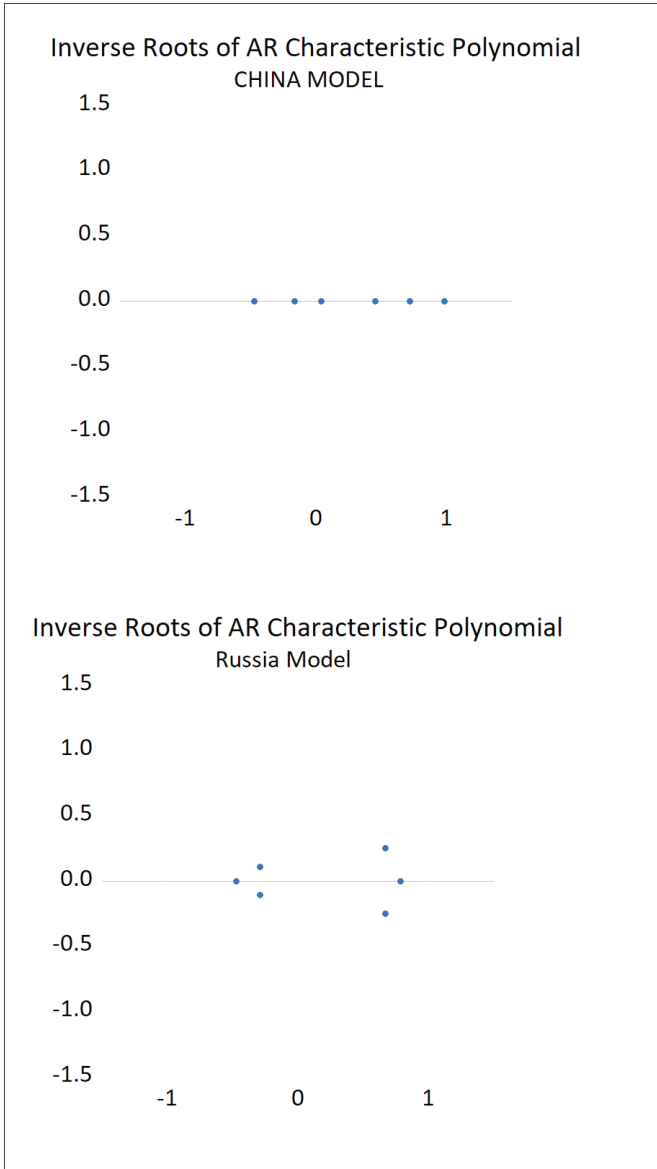

In the next step, historical decomposition results for China and Russia are obtained. In this context, let's examine the historical effects of glasnost and perestroika policies in terms of their impact on the financial development of China and Russia, respectively.

If we interpret the results for China:

Glasnost policies financial development; While it affected the financial development negatively in the 1992, 1993, 2003, 2005-2013, and 2015-2019 periods, it affected the financial development negatively in the other periods. While the most potent positive effect was observed in 2005, the most substantial negative impact was in 2014.

Perestroika policies; While it affected financial development positively between 1995, 1997, and 2005-2015, it had a negative effect in other periods. While the most potent positive effect was observed in 2010, the most substantial negative impact was in 2015.

If we interpret the results for Russia:

Glasnost policies; While it affected financial development positively in the 1993, 1997, 2000-2001, and 2015-2019 periods, it had a negative effect in other periods. While the most powerful positive impact was detected in 1997, the most substantial triple negative effect was observed in 2010.

Perestroika policies; While they affected financial development positively in the 1993-1997, 2003-2006, and 2017-2019 periods, they had a negative effect in other periods. While the most potent positive effect was observed in 2004, the most substantial negative impact was followed in 2008-2010.

### Historical Decomposition using Generalized Weights

#### Decomposition of China Financial Development

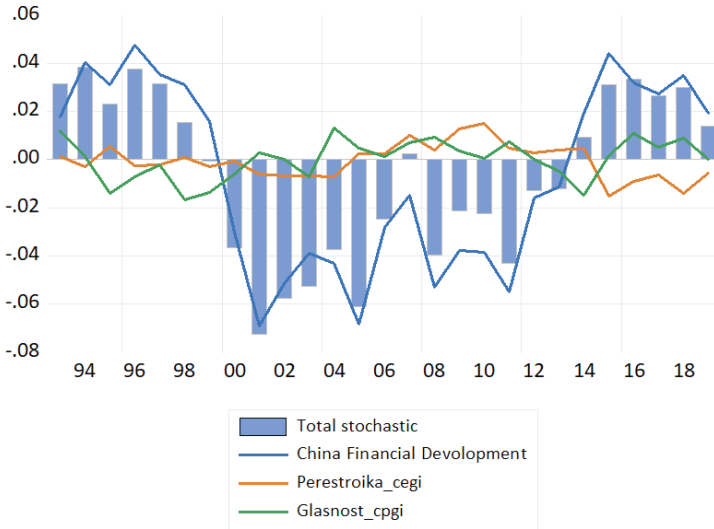

### Historical Decomposition using Generalized Weights

#### Decomposition of Russia Financial Development

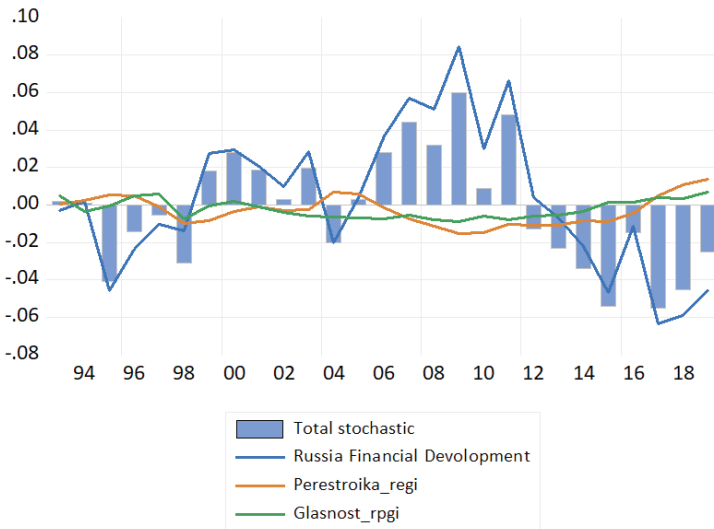

## CONCLUSION

After the Second World War, there was a fierce competition dynamic in every field, from politics to the world of economy and finance, between NATO as military, the Western world alliance system represented by the USA politically, and the Eurasian alliance bloc described militarily by the Warsaw pact and the USSR politically. Has emerged.

As in the Cuban missile crisis, this rivalry has come from the brink of evolving into a nuclear world war from time to time. Although it is not a member of the Eurasian alliance bloc in the military sense, With the communist regime established after the Chinese civil war, Eurasia tended to be closer to the alliance bloc.

In this process, the global financial system and financial markets emerged as economic phenomena within the power field of the western world. The currency crisis that started in China in 1978, the increasing systemic risks in the socialist structure, and the systemic inefficiencies in the Soviets in the 1980s pushed both countries to change the fundamental economic and political paradigms that dominated their states.

In this context, both countries started to implement a recovery dynamic for their inefficient and weakened countries by initiating perestroika, which means economic openness, and glasnost, which means political transparency, in the 1980s.

In the continuation of this process, the cold war ended with the dissolution of the USSR in 1991. In the following period, the Russian Federation was established. In the 1990s, while the basic political economy mechanisms in both China and Russia converged to the practices of state capitalism, the perestroika and glasnost reform processes continued.

In this direction, while China opened its country to private enterprises and international direct and portfolio foreign investors, Russia, with its privatization policies, privatized the former large companies of the USSR through Russian oligarchs and presented Russia's energy and raw material reserves to international commodity and financial markets. Subsequently, while China continued these policies until the Covid period, Vladimir Putin, who came to power in Russia in 1999 with the Nationalist Russia thesis, reversed some of the reform processes and turned to the re-nationalization policy of Russia's essential companies and energy-raw material reserves. On the other hand, it has tried to make Russia a more dominant actor geopolitically with its military operations in countries such as Georgia, Syria, and Ukraine.

In the process of evolving from socialism to state capitalism as the primary paradigm in the current process, the integration process of China

and Russia into global financial markets has increased with economic and political openness policies. In this context, the financial development of China and Russia showed an increasing trend in the 1991-2019 period. However, in Russia's performance, the sanctions faced by Russia due to its more active and effective foreign policy have revealed periods of a structural break in financial development from time to time (See Figure 1). On the other hand, when China turned into a manufacturing empire, it displayed an isolationist tendency similar to the Monroe doctrine in foreign policy in order not to politicize international export goods.

This study aims to differentiate the historical effects of perestroika, which means economic openness, and glasnost, which means political exposure, on financial development, which China and Russia implemented during the transition to state capitalism after the cold war. In this context, if we summarize the results;

If we interpret the results for China;

Glasnost policies financial development; While it affected the financial development negatively in the 1992, 1993, 2003, 2005-2013, and 2015-2019 periods, it affected the financial development negatively in the other periods. While the most potent positive effect was observed in 2005, the most substantial negative impact was in 2014.

Perestroika policies; While it affected financial development positively between 1995, 1997, and 2005-2015, it had a negative effect in other periods. While the most potent positive effect was observed in 2010, the most substantial negative impact was in 2015.

If we interpret the results for Russia;

Glasnost policies; While it affected financial development positively in the 1993, 1997, 2000-2001, and 2015-2019 periods, it had a negative effect in other periods. While the most powerful positive impact was detected in 1997, the most substantial triple negative effect was observed in 2010.

Perestroika policies; While they affected financial development positively in the 1993-1997, 2003-2006, and 2017-2019 periods, they had a negative effect in other periods. While the most potent positive effect was observed in 2004, the most substantial negative impact occurred in 2008-2010.

If we interpret the results for China; basically, it can be construed that glasnost and perestroika policies affected the financial development more China during the periods when the systemic risks of political and economic crises such as the Middle East wars in the western world and the 2008 global financial crisis increase. Today, this issue underlies the US-

China rivalry. When the Western system is dragged into crises, it can be said that China is seen as a substitute for the USA for all global economic and political actors. Openness policies for China have a more positive effect on financial development in these periods. With this, The trade wars that started with the Trump era caused the competitive dynamics of perestroika policies to affect financial development negatively.

If we interpret the results for Russia, It can be stated that openness policies negatively affect financial development due to the economic, financial, and political international sanctions that come during the military operations carried out by Russia beyond its borders. In particular, economic openness and perestroika policies positively impacted financial development in crisis-free periods when relations between Russia and the USA were more favorable.

In short, openness policies contribute more positively to financial development due to China's substitution position against the USA during the risk periods that arise in the west for China; The periods when Russia did not carry out military operations and its relations with the USA were more moderate contributed more positively to the financial development of openness policies. For both countries, it can be said that perestroika policies, in terms of both negative and positive effects, have a relatively more significant impact in terms of glasnost policies. This issue can be associated with the fact that it has many more elements that connect the global economy and financial system and work effectively compared to the international political order.

## REFERENCES

- Baker, S.G. (2017). Perestroika: : Economic Growth and the USSR's Final Decade., <https://www.semanticscholar.org/paper/Perestroika%3A-%3A-Economic-Growth-and-the-USSR%E2%80%99s-Final-Baker/ac8bfe81e64e11bbd5559a103986c53f4b0c0c55> , Acces Date, 15.10.2022
- Balcılar, M., Ozdemir, Z. A., Ozdemir, H., & Shahbaz, M. (2018). The renewable energy consumption and growth in the G-7 countries: Evidence from historical decomposition method. *Renewable Energy*, 126, 594-604.
- Burbidge, J. & Harrison, A. (1985), An historical decomposition of the great depression to determine the role of money, *Journal of Monetary Economics*, 16, issue 1, p. 45-54.
- Dickey, D. A., & Fuller, W. A. (1979). Distribution of the estimators for autoregressive time series with a unit root. *Journal of the American Statistical Association*, 74(366a), 427–431.
- Egreteau, R.(2022). Conclusion: *glasnost* without *perestroika*' caretaking *democratization: the military and political change in Myanmar* (2016;) online edn, Oxford Academic18 May 2017), <https://doi.org/10.1093/acprof:oso/9780190620967.003.0008>, accessed 10 Oct. 2022.
- <https://data.imf.org/?sk=f8032e80-b36c-43b1-ac26-493c5b1cd33b>, Acces Date; 10.10.2022
- <https://kof.ethz.ch/en/forecasts-and-indicators/indicators/kof-globalisation-index.html>, 10.10.2022
- Kurt, H. (2021). The Times gazetesinde Gorbaçov'un glasnost ile perestroyka politikalarını uygulaması. *Akademik Tarih ve Düşünce Dergisi* 8 (2021 ): 1350-1381
- Williams, R.(1985) [1976]. "Capitalism." *Keywords: A Vocabulary of Society*. Oxford paperbacks (revised ed.). New York: Oxford University Press. p. 52. ISBN 9780195204698.
- Sims, C., A. (1980) "Macroeconomics and Reality." *Econometrica*, vol. 48, no. 1, 1980, pp. 1–48. JSTOR, [www.jstor.org/stable/1912017](http://www.jstor.org/stable/1912017). Accessed 15 July 2020.
- Smirnov, A. D., & Ershov, E. B. (1992). Perestroika: A Catastrophic Change of Economic Reform Policy. *The Journal of Conflict Resolution*, 36(3), 415–453. <http://www.jstor.org/stable/174342>



“

## Chapter 23

**REFLECTION OF TURKISH  
MYTHOLOGICAL SYMBOLS ON  
PRINTMAKING ART**

*Dizar ERCIVAN ZENCIRCI<sup>1</sup>*

”

---

<sup>1</sup> Assoc. Dr., Ege University Fine Arts Education Department. [dizar.ercivan\\_zencirci@ege.edu.tr](mailto:dizar.ercivan_zencirci@ege.edu.tr) ORCID ID: 0000-0002-6256-7876

## 1. Introduction

Myth texts belonging to historical-cultural tradition constitute Mythology. Mythology has a very important role in transferring the social life, culture, history and beliefs of a society to the next generations. The transfer of the past memory of all societies to the next generations was provided primarily by oral and then written tradition. Mythology, which constitutes the starting point in history and national culture, has established a systematic connection with folk culture and life. The source of stories, folklore, riddles, legends and other genres in folk culture is mythology (Yılmaz, 2014: 234).

The word myth is “mythus” in German, “mythe” in French, “myth” in English, and “mif” in Russian. The word mythology is; It is called Mithologie in German, Mithologie in French, and mythology in English. The old form of the word “mythos”, “muthos”, as well as meanings such as legend, word, discourse, narrative, rumor, news, conversation, conversation, advice, command; fairy tales, fables, lies, fabrications, etc. also means (Bayladı, 2010: 7). Mythology: “The source and historically oldest form of national-traditional culture. Mythology is a dynamic system of signs that explains the creation with its own laws and regulates the thought potentials and behavior patterns of ethnic-cultural tradition bearers” (Beydili, 2004: 390). “Myths give people the opportunity to determine their place in time, to establish a connection with the past and the future. Therefore, the myth world is closely connected to the real world” (Özden, 2003: 13). Mythology does not explain the events, but the reasons for the occurrence of events. It does not paint a picture of the real world. It enables the realm to be grasped with symbols (Bayat, 2007: 5).

The first paintings drawn on the cave walls strengthened the emergence of images and mythology symbolizing supernatural reality, coping with this reality and being able to control it. “From this point of view, myths are like an organism that carries something from every community and culture it lives in, that changes and develops as it lives” (Gezgin, 2008: 7). Mythology is as old as human beings, creating an oral culture environment, from thought to sounds, from sounds to words and sentences. “...after learning how to write, “Myths” became thinner and more beautiful with the efforts of poets, tragedies and great philosophers. Then the “Myths” did not stay attached to one place. The nations that were migrating went after them. They multiplied and spread by passing from mythology to mythology, from religion to religion, they mixed with new beliefs and adapted themselves to them by carrying the remnants of lost beliefs. Even a “Myth” born in the same land found its maturity in language, idiom, imagination and beauty over time. But he kept the

environmental characteristics of the country where he was born and grew up” (Can, 1970: 3-4).

Myth can be defined as stories that reflect the divine order according to some, about the creative power or powers, creation and existence, life, extinction and related issues that people have created since they knew their existence and developed depending on a fictional time and place. It can be considered as a field of social science that examines them with the scientific method (Çoruhlu, 2021: 11).

## **2. Turkish Mythology**

Especially Turkish mythology, which was late to written culture, was influenced by different myths and even changed, but did not lose its essence. It is seen that the studies on Turkish mythology were generally carried out after the proclamation of the Republic and these studies continued increasingly.

Inscriptions belonging to ancient Turks, tombs and written sources of ancient and deep-rooted civilizations such as China, which has close relations with Turks, shed light on the subject of Turkish myths, which passed from oral tradition to written culture late. The concept of “oral culture” began in the 19th century with the German brothers Jacob and Wilhelm Grimm. The Brothers Grimm studied various local dialects, wandering through villages and towns, compiling old German poems, tales and legends that have been told for centuries, and published them in a literary style in 1812. This approach pushed other nations to research their own tales, legends and mythologies. This initiative of the Grimm brothers has accelerated the studies on researching and spreading Turkish legends, epics and tales in Turkey as well as in the world, especially after the Republic. Researching and revealing myths 19-20. It goes back to the century. We can say that the prehistoric old Stone Age is the beginning of Turkish mythology. “When we look at the researches, it has been determined that most of the myths and rites found in all of the Anatolian civilizations and especially in the Hittites emerged in Upper Mesopotamia and spread to Anatolia and Greece from there” (Bender, 2007: 19).

Today, it is possible to obtain information about Turkish Mythology from both written and unwritten sources. The works that emerged as a result of archaeological excavations such as kurgan and balbal can be benefited from, as well as the first Turkish inscriptions, epics and the cultures of the Turks, who spread from Central Asia to the interior of Europe, are other elements that provide information about Turkish mythology (Kahraman, 2020: 1). Turks are a nation that has been fused with mythology since ancient times and adapted mythological beings to their lives. The basis of Turkish mythology is the Sky God. Accordingly, we can say that Turkish

mythology is dependent on the understanding of “theism” (Yılmaz, 2014: 234).

As in all world cultures, natural events faced by people have shaped their lives and beliefs in Turks. “Therefore, he called the sky, the earth and the water a god. He did it by experiment, in a way, by primitive experiment. He called all beings that exceed human power and human understanding, especially all natural events from mountains, seas, rivers, lakes, rain to snow, storms, lightning, lightning and thunder as gods” (Eyuboğlu, 2007: 42).

## 2.1. Gods and Goddesses in Turkish Mythology

In Turkish mythology, there are multiple gods and goddesses with different sacred duties in the formation of the universe. The Gods and Goddesses that have influenced Turkish plastic arts and have appeared in many works for years are given below:

### **Mother Gods and Goddesses**

Tengri - The main god of the Turkish pantheon, who controls the celestial sphere, the Sky God (Tengri) is the creator of everything.

Kayra (Kaira) - Kayra, the son of the sky god, is the God of the universe. He is the spirit of God and the creator god.

Erlik (Erklik-Erklikhan) - God of the dead and the underworld.

Ülgen (Ulgen) - Ülgen, son of Kayra, is the god of goodness.

Mergen - God of abundance and knowledge and son of Kayra.

Kızagan - God of war of the European Huns, son of Kayra and brother of Ulgan.

Umay (Umai) - Goddess of fertility and virginity.

Kubai - Goddess of childbirth, mother and child. It gives spirit to children as it protects women who give birth.

AkAna - White Mother, also known as the water goddess, is the goddess of creation. He is the creator of the Turkish people.

Gün Ana-Day Mother is the common goddess of Kazakh and Kyrgyz mythologies and is known as the Sun Goddess.

Ay Ata- Moon Father, who lives on the sixth floor of the sky with Gün Ana, is the moon god.

Koyaş (Kuyaş) - Koyaş is the Sun God, the son of the Sky Tengri and the Earth Goddess.

Yeliyesi - The god of wind and is called the “wind king” in Hungarian folklore.

Wind Mother - She is the goddess of wind and in Hungarian mythology her name is “Wind Queen”.

Bürküt Ata - Bürküt Ata, who symbolizes the sun and power, is the “Eagle God”.

Boz Tengri - Often considered the god of the earth and steppes.

Ayzıt - The goddess of beauty, Ayzıt is also the mother goddess of the Yakut people in Siberia.

Su İyesi-Water Elite - Appearing as an old man with a greenish beard and frog-like face, his body covered with mud and moss, this god is known as the Water god.

Su İyesi-WaterElite - Unlike the water god, the Water possessor, who appears as a naked young woman with a fairy face, is the Water goddess.

Od Ana – Od Mother, known as the “Queen of Fire” in Mongolian mythology, is the goddess of Fire. She is also known as the goddess of marriage.

Od Ata - Od Ata, the god of fire, is referred to as Od Khan (fire king) in Mongolian mythology.

Alaz - The god, also known as Alas-Batır or Alaz Han, is the god of fire in Turkish mythology.

Hormuz (Kurmez) - Described as the chief of 55 Gods in Mongolian mythology and shamanism, Hormuz is the god of spirits.

Etügen - The name of Etügen, the Goddess of the World, comes from Ötüken, the sacred mountain of the earth and the fertility goddess of the ancient Turks.

Jaiyk - God of rivers and a god in the Turkish pantheon known as Dayik in Altai mythology.

Bayanay - Goddess of the hunt. She is also the goddess of forests and joy for the Yakuts.

### **Kailyn - God of kings and queens.**

Apart from the main Gods and Goddesses listed above, the mountain god Adagan, the medicine god Akbuğa, the ruby god Ai Toyon, often depicted as an eagle perched on the top of the “world tree”, the god of the hunt Şalık, the goddess of childbirth and labor pains Inehsit, the sky god Kovak, the harvest goddess Uren, Goddess of Judgment Zarlık, God

of Wind Zada, ruler of rivers and springs, Ukulan God of Water, God of oceans Talai (Talay/Dalai), God of wild animals Izih, God of Thunder Kvara (Kuara) of Bulgarian origin etc. They are known as other gods and goddesses in Turkish mythology.

## 2.2. Symbols and Meanings in Turkish Mythology

**Tree of Life:** The tree of life, which is identified with derivation in Turkish culture, is the symbol of life and eternity. “The stories about the derivation from the tree in the legends are symbolized as the continuation of life of the femininity and holiness of the tree. It is also considered as a common feature with women that the tree gives fruit due to its structure, dries out, turns green and bears fruit in the seasonal cycle” (Çoruhlu, 2011: 130).

**Flower:** In Turkish culture and art, the flower motif is used in rugs, carpets, tiles, tents. It appears as a motif symbolizing heaven. The fact that it symbolizes heaven is an indication of belief in the afterlife (Vural, 2018).

**Pomegranate:** The belief that it carries symbolic meanings such as abundance, fertility, birth, life and immortality is dominant in the belief system of the society (Çağlıtütüncügil, 2013: 78). The symbol of the Anatolian Hittite goddess Kubaba and of Hera and Aphrodite in the Hellenes is the pomegranate. The symbol of pomegranate was included in the subjects including all kinds of birth, growth and reproduction ideas, and the wares and even the jars in which the grains were kept in the ceremonies were decorated with pomegranate motifs, and expectations such as abundance and fertility were expressed (Ateş, 2001: 175-176).

**Sun and Moon:** The sun is considered sacred by the Turks. It is widely believed that the Sun is female and the Moon is male. The female is associated with Güneş Umay. For Turks, the sun became the symbol of the east and the moon the symbol of the west. They sacrificed for the Sun and the Moon (Ögel, 1971: 168). The sun has been one of the most basic elements necessary for the maturation and vital cycles of plants (Şenses, 2001: 212).

**Wolf:** Based on legends and epics, the most important animal in Turks is the wolf. The wolf became the ancestor of the Turks, sometimes appearing as a guide and sometimes as a savior (Durmuş, 2009: 103). It is an animal-ancestor or animal-mother symbol (Almutak, 2002: 422).

**Deer:** Turks gave great importance to deer. Deer has become the symbol of some Turkish tribes such as the Bozkurt. In this respect, deer

motifs are frequently encountered in Turkish mythology and legends (Aytaş, 1999: 161).

**Horse:** In Turkish epics and oral narratives, the horse is the companion of the Turks. Horse figures in epics are extremely fast, they cross mountains and streams at once. They are described as human-like, understanding and emotional, and hovering like a bird (Gültepe, 2015:590-593). In shamanistic ceremonies, the horse has an important place as a mount and sacrificial animal that the shaman will take to the skies. Since the horse can go underground or to the other world, it is depicted as a symbol in death, and the white horse is expressed as the representation of the sky and the black horse is the earth element. (Çoruhlu, 2011:181-182).

**Taurus:** Since it is the symbol of strength and power, it is also considered a symbol of ruler or sovereignty. In Dede Korkut stories, the bull is a symbol of power, strength and bravery (Çoruhlu, 2011: 177).

**Goat:** Goat is the totem and taboo of some tribes in ancient Turks. There is also a goat motif in Hittite mythology. A being is believed to be protecting goats among the Kyrgyz and this being is called “Çiçan Ata”. For the first time, a goat with iron horns and a sky mane foretells that there will be a flood among Altai Turks (Armutak, 2013: 419).

**Fish:** It is believed that the fish in the Altai creation epic helped to create the world and that the world stood on fish. It was seen as a symbol of fertility for Turks, as a symbol of happiness and reproduction in marriages, which were counted as good luck and abundance (Çoruhlu, 2011: 177).

**Non-predatory Birds:** In Turks, the bird, which is under the control of the Sky God, is a sacred being. The bird, which is believed to bring good luck to people, also symbolizes heaven. “It is a very common thought among Turks that the souls of the deceased fly to the sky as a bird” (Ögel, 1993: 129).

“The pigeon, which has settled around the places of worship and tombs, has assumed a protective quality in the society. In addition, the news of the end of Noah’s Flood and the return of beautiful and carefree days made it a symbol of peace and innocence worldwide” (Yayan and Kılıç, 2014: 46). According to the Qur’an, the bird is a symbol of immortality. The black bird is associated with intelligence, the green and blue bird, the inspiration of love, the white bird with lust, the red bird with otherness and immortality (Ersoy, 2007: 88). The peacock has been the symbol of beauty, dignity and honor, the pigeon has been the symbol of long life, the goose has been the symbol of masculinity, marriage and success (Çoruhlu, 2011: 187).

**Rooster-Chicken:** In many cultures, the rooster has been perceived as a symbol of the sun and pride, and a relationship has been established between its crow and the sunrise (Dalkıran, 2017: 338). In Turkish mythology, rooster and chicken are symbols of protection and peace, expelling evil spirits.

**Woman:** The female figure appears in mythology as both a goddess and a spirit. Female fertility is the symbol of life and continuity that ensures reproduction (Çoruhlu, 2011: 42). In Turkish culture, mother Umay is known as the protector of marriage and children (Küçük, 2013: 117).

### 3. Mythological Images in Turkish Plastic Arts

As the artist reflects the nature with the effect of his intuition in his paintings, mythological tales, stories, gods and goddesses triggered the artist's creativity and became the subject of his works. While the mythological elements that reflect the traces of the historical past of societies are blended with the structure of the natural and social environment, the artist carries this blend to his works, keeping the culture and identity of the society alive and alive. It is seen that anything real or not can be an object of art. In this context, mythologies that reflect human life and beliefs are also the subject of art.

According to Tökel (1998), there is a two-dimensional relationship between mythology and art as direct and indirect. "The need for knowledge of mythology in order to understand and analyze some sculptures, caves, cemeteries, monuments and temple paintings; It is an example of the first relationship between mythology and branches of art. The other relationship is based on the evaluation of mythological elements as figures, materials and images in literary texts or works belonging to fields such as painting, sculpture and architecture" (Tökel: 1998: 33). In the first dimension, mythology is in the interpretation and analysis of the work; In the second, it is effective in the production phase. The artist needs knowledge of mythology and mythological elements both in producing his work and in solving his work.

The more effective the language is in expressing our ideas in a literary work, the more effective are symbols and myths for painting. "Symbols or myths express the relationship between conscious or unconscious experiences, one's present individual existence and human history. Symbol and myth are living and immediate forms emerging from the encounter. There is a mutual interaction in which the dialectical interrelation of the objective and subjective poles will be affected by the change in one of them" (May 1992: 99).



Myths, which are the product of behavior and thought of different societies and oral culture, have reached an artistic dimension as a form of literary and formal expression. It is seen that the themes and symbols that contain mythological stories are a source for Turkish artists' canvases, papers and sculptures in different techniques and styles, triggering their creativity. "It is of great importance for artists to produce works by utilizing Turkish mythology, in order not to forget the value judgments, religious beliefs, symbolic approaches, ethical understanding and lifestyles from the past to the present in the myths and legends of Turkish culture and to pass them on to future generations" (Büyükkol, 2020, p. 113). "In this context, the artist has created unique images in today's art by using the traditional language of painting and sculpture by going beyond the usual images of mythological stories in classical art in the subjects and paintings he has worked on" (Mansuroğlu, 2018: 2).

When we examine Turkish art, it is seen that artists who produce works in different fields and styles such as architecture, sculpture, painting, ceramics and printmaking are influenced by mythological subjects and figures. The magic of stories, tales and stories told about gods, heroes, extraordinary events, the universe, events of previous ages, which are told from word to word, from writing to painting, affect the artist.

Mythological symbols, traces of which we find in rock paintings and kurgans in Central Asia, are seen in many architectural structures in Anatolia, such as carpets, rugs, and ceramics. Printmaking artist Süleyman Saim Tekcan, who has an important place in contemporary Turkish art, produced works by using mythological figures such as horses and deer in his unique style in his paintings and prints. The engravings he named "Horses and Calligraphy" make an important contribution to keeping our mythological symbols alive in the memories". Bedri Rahmi Eyüboğlu, Hüsametdin Koçan, Nuri Abaç, Birsen Ceken, Rauf Tuncer, Mehmet Özkartal, Mehmet Sağ, Mezahir Ertuğ Avşar, Mürşide İçmeli are our other important artists who use mythological symbols in their works.

## **4. Mythology Theme in Turkish Original Printmaking**

### **4.1. Can Göknil (1945- )**

Can Göknil graduated from Istanbul Robert College in 1966. She graduated from the Painting Department of the Faculty of Fine Arts at Knox College in 1968. She then completed her master's degree in painting at the City College of New York. Returning to Turkey in 1973, Göknil published her first picture story book, *The Hedgehog Tale*, a year later. The artist, who works in the fields of painting and literature, has published approximately fifty picture books in Turkey and six picture books abroad

in English, French, German, Italian, Hungarian, Flemish and Arabic. In addition to his books, her works in the field of plastic arts are included in various collections in the world and in Turkey.

Can Göknil carries the knowledge gained as a result of his deep researches on Turkish mythology to his works with his unique style and technique. Göknil said, “My interest in mythology is a choice that comes from wanting to know the essence of our culture. While preparing an exhibition, I find a theme or motif based on Turkish culture and research it. As I research, I learn both myself and the subjects I learn create enthusiasm in me... Therefore, mythology is very suitable for me, because my narrative side is strong. Stories move me. I start to think and see the subjects I research as pictures” (Dalkıran, 2010: 86).



**Picture 1.** Can Göknil, “Ak Ana and The Tree”, Engraving, 29x30 cm, 2002  
(<https://cangoknil.com/tr/portfolio/yaratilis-legends/>)

It is seen that Can Göknil’s Engraving work of the Creation Myth series titled “White Mother and Tree” forms the central composition within the square. Known as the creator goddess of the Turks and the goddess of water, Ak Ana is in the center of the work, sitting on the ground in the foreground. The fish, which is the symbol of reproduction and fertility in its lap, is in the foreground and center of working with a few other sacred animals around it. Just behind it, there are women,

goats and birds on the branches of the great, great Tree of Life, which is identified with derivation in Turkish mythology. “I draw beings that come to life on treetops among the clouds in Akana’s world. Then I want to work on the same drawings with the engraving technique. The desire to embroider the same patterns on different materials provokes me. Thus, I begin to engrave my drawings on the zinc” (Göknil, 2016: 51).

#### 4.2. Mürşide İçmeli (1930- 2014)

She graduated from Ankara Gazi Education Institute Painting Department in 1953 as an art teacher. In 1959, she entered Ankara Gazi Education Institute as a graphic assistant. With a government scholarship, she went to Madrid in 1960 to research, analyze and specialize in printmaking. One year after returning home, she was sent to London in 1962 to be trained in graphic arts. When she returned to his homeland in 1965, she worked as a Graphic Arts Teacher in Gazi Education Institute Painting and Crafts Department, and as a Professor in the Graphics Department at Bilkent University Fine Arts Faculty between 1986-1995. She worked in printmaking from her retirement until her death.



**Picture 2.** Mürşide İçmeli, “Tree of Life”, Engraving, 48.5x31 cm, 1974

Mürşide İcmeli's works with an abstract approach generally integrate people, human masses and nature with engraving technique within the sharp geometric structure. The artist states that she prints with all traditional printing techniques, among which engraving is attractive to her. "The engraving has a distinctive style of spots and lines. When we use it consciously, we get an atmosphere that we cannot achieve with any technique. I don't want to leave this to chance. I check every line and stain I put on the picture over and over. For this reason, I see engraving as a very suitable technique for my production. I persistently continue to work in this technique, as it provides great opportunities for shaping my compositions" (cited by İcmeli, Yaman 1995: 46). Black dominance is seen in İcmeli's 1974 "Tree of Life" engraving work. In the study, it took shape with squares and circles in the inclusive main form. The geometric tree interpretation at the top of this inclusive form is given with textural richness. In the roots of the sacred "Tree of Life", there are people in a circle, and in the square below it, idols, which have an important place in Anatolian culture in the construction of tactile and visual texture with relief.

### **4.3. Süleyman Saim Tekcan (1940- )**

Born in Trabzon, the artist graduated from Ankara Gazi Education Institute Painting Department in 1963, which he entered in 1961. He completed his undergraduate degree from the Painting Department of the Istanbul State Academy of Fine Arts (Mimar Sinan University) and his Proficiency in Art at the Faculty of Fine Arts at Mimar Sinan University. 1970-1971 The artist, who made researches on printing education in Germany, worked as a lecturer at different universities after returning home. He was the founder of the Istanbul State Academy of Fine Arts, the printing workshops of the Çamlıca Art House and the IMOGA Istanbul Graphic Arts Museum.

Süleyman Saim Tekcan saw the possibilities of expression of screen printing and engraving, which are among the printing techniques, close to his style. "Tekcan, who can use all the possibilities of engraving techniques in zinc and copper molds, conveys the organic and fluid forms created by the melting of metal by liquid acid, evoking biological and natural processes, and allowing for diversity and texture richness" (Erzen, 1982: 28).

We see that Tekcan's early works focused on Turkish Variations. In his first exhibition (1976), which consisted of serigraphy, engraving and lithography works, the main subjects were Anatolian women and children. In the serigraphies of that period, the general composition elements; Anatolian civilizations, Seljuk, Ottoman origin, Turkish motifs (forms

in the form of sun course, ale, deer idols, tugras, etc.) are calligraphic arrangements. However, these were created by abstracting and blending them with contemporary art. In particular, we see these idols and Anatolian motifs in their works based on ‘Anatolian Civilizations’. While these motifs are abstract in Turkish variations, they become concrete in Anatolian Civilizations. The main philosophy of these studies; is the idea of protecting the past and keeping our culture alive (Vural, 2020: 133).

Tekcan reaches the richness of style and expression by interpreting the themes he chooses as the subject of print painting with oil painting, acrylic and sculpture techniques. Horse, the mythological element of Turkish culture, is blended with sun discs and Anatolian motifs in the abstract background of the composition created by the artist. In 1988, the artist took part in the compositions of human figures and some idols, as well as horses, in his works in the exhibition ‘Horses and Horsemen’. In 1993, in the “Atlar ve Calligraphy” series, figures were combined and interpreted with the rich expression opportunity of calligraphy and calligraphy engraving.



Picture 3. Süleyman Saim TEKCAN, “Untitled”, Engraving, 32x14 cm., 2002



## Hasan Kıran (1966- )

The artist, born in Malatya, graduated from İnönü University, Faculty of Education, Painting Department in 1993 and continued his studies in Germany between 1995-1997. In 2008, with his thesis on “Visual Propositions on Shamanistic Images”, he received the title of “PhD in Art” (Ph.D.) from Tokyo State University of Art. He made researches (post doctorate) on “Contemporary Printmaking Methods and the Example of Japan” in Istanbul University. Kıran, who has awards in his field, has works in collections at home and abroad.

Kıran’s printmaking works are based on shamanistic images and mythical thoughts. We can say that his art is the transformation of mythical myths into expressive visual propositions. Especially in Shamanism, he prefers woodcut technique in his compositions, which are heavily fictionalized with symbols and myths in the original structure. Within the scope of the shamanist belief, it is seen that he used the color woodcut technique in the Far-Eastern and Western style, which has existed for 2000 years, in the series “Shaman’s Dance”, “Shaman’s Trance”, “Rite Ceremony”, “Shamans Confrontation”.

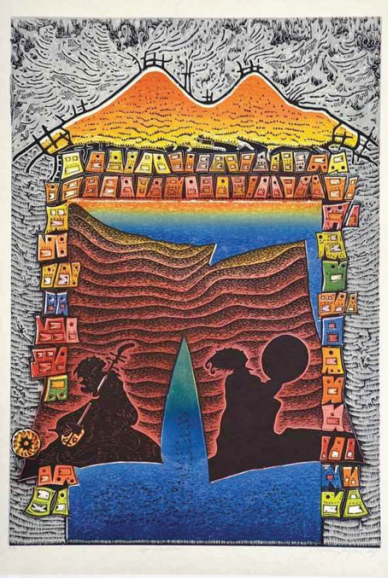
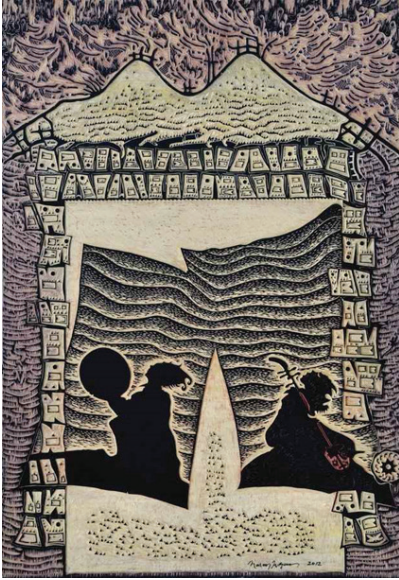

**Picture 4.** Hasan Kıran, “Songs to Ülgen” Plate, 120x85 cm, 2012

**Picture 5.** Hasan Kıran, “Songs to Ülgen” Woodcut, 120x85 cm, 2012

## **5. Conclusion**

Mythological myths have been the subject of plastic arts and painting for centuries. Especially in European art, Greek Mythology triggered the creativity of painters, gods and sacred animals were reflected on canvases and sculptures as visual forms.

Mythological myths and tales, which are the expression language of Turkish art, have influenced artists for years. These stories, which are handled in different styles and techniques, also affect contemporary Turkish art. Recently, Turkish mythology has been taught as a course in higher education institutions providing art education and has been the subject of research. It is promising to include mythology lessons in many higher education institutions where art education is given, to protect our cultural heritage and to transfer it to the younger generations and the world.

## REFERENCES

- Armutak, A. (2002). “Dođu ve Batı Mitolojilerinde Hayvan Motifi”, İ.Ü. Veteriner Fakültesi Dergisi, 28 (2), s. 411- 427.
- Ateş, M. (2001). *Mitolojiler ve Sembolleri*. İstanbul: Aksieda Matbaası.
- Aytaş, G. (1999). TÜRK KÜLTÜR VE EDEBİYATINDA GEYİK MOTİFİ VE ‘HAZA DESTAN-I GEYİK, Türk Kültürü ve Hacı Bektaş-ı Veli Araştırma Merkezi Dergisi, Sayı 12, s. 161-170.
- Bayat, F. (2007). *Türk Mitolojik Sistemi (Kutsal Dişi, Mitolojik Ana, Umay Paradigmasında İkel Mitolojik Kategoriler, İyeler ve Demonoloji-2)*. İstanbul: Ötüken Neşriyat A.Ş.
- Bayladı, D. (2010). Sorularla Mitoloji. İstanbul: Omnia Yayınları.
- Bender, C. (2007). Kürt Mitolojisi. (3. Basım). İstanbul: Berfin Yayınları.
- Beydili, C. (2004). Türk Mitolojisi Ansiklopedik Sözlük. Ankara: Cantekin Matbaası.
- Büyükkol, S. (2020). TÜRK MİTOLOJİSİNDEKİ NAR SEMBOLÜNÜN ÇAĞDAŞ TÜRK RESİM SANATINA YANSIMALARI. *Ulakbilge Sosyal Bilimler Dergisi*, 8(44), 109-121.
- Can, Ş. (1970). Klasik Yunan Mitolojisi. İstanbul: İnkılâp Kitabevi.
- Çağlıtütüncügil, E. (2013). Türk Süsleme Sanatında Nar: “Form, Köken Ve Bilgiç, Emin-Vd. (1990)”, Ankara Kültepe Tabletleri I. Türk Tarih Kurumu Basımevi. Ankara
- Çoruhlu, Y. (2011). Türk Mitolojisinin Ana Hatları, Kabalcı Yayıncılık.
- Çoruhlu, Y. (2021). Türk Mitolojisinin Kısa Tarihi. İstanbul: Alfa Araştırma, Alfa Yayıncılık.
- Dalkıran, A. (2010). Çağdaş Türk Resminde Şamanist Etkiler, Selçuk Üniversitesi Eğitim Bilimleri Enstitüsü Güzel Sanatlar Eğitimi Anabilim Dalı Basılmamış Doktora Tezi, Konya
- Durmuş, İ. (2009). Bilge Kağan, Köl Tigin ve Bilge Tonyukuk, Ankara: Maya Akademi Yayınları.
- Ersoy, N. (2007). *Semboller ve Yorumları*. İstanbul: Dönence Basım.
- Erzen, J.(1982). Süleyman Saim Tekcan’ın Gravürleri, Sanat Çevresi Dergisi 4(4), 8-11.
- Eyubođlu, İ. Z. (2007). *Anadolu Mitolojisi*. İstanbul: Derin Yayınları.
- Gezgin, D. (2008). Paleolitik Çağlardan Hıristiyanlığa Kadar Sanatın Mitolojisi. İstanbul: Sel Yayıncılık.
- Göknil, C. (2016). Mitolojiden Sanat Notlar Gölge Renkli mi? (2.Baskı). İstanbul: Can Sanat Yayınları.



- Gültepe, N. (2015). *Türk Mitolojisi*. İstanbul: Resse.
- Hekimoğlu, M. (24 Nisan 1994). “Çiçekli Tanrıçalar”. Cumhuriyet Dergi: 422, 9.
- Kahraman, M. (2020). *Türk Mitolojisinde Temel İnançlar (Kozmogoni, Astroloji, Renkler)* Doktora Tezi, Ankara Yıldırım Beyazıt Üniversitesi Sosyal Bilimler Enstitüsü).
- Küçük, M. A. (2013). Geleneksel Türk Dinindeki ‘ Ana/ Dişil Ruhlar’ a Mitolojik Açıdan Bakış. *İğdır Üniversitesi İlahiyat Fakültesi Dergisi* , 105-135.
- Mansuroğlu, A. (2018). Hatay Mustafa Kemal Üniversitesi Sosyal Bilimler Enstitüsü Sanat ve Tasarım Ana Sanat Dalı, Taner Ceylan’ın Altın Çağ Sergisi Bağlamında Günümüz Resminde Mitolojik İmge Kullanımı, Yüksek Lisans Tezi, Hatay.
- May, R. (1992). Yaratma Cesareti, İstanbul: Metis Yayınları.
- Ögel, B. (1971). *Türk Mitolojisi* (Cilt 1/2). İSTANBUL: Milli Eğitim Basımevi.
- Ögel, B. (1995). *Türk Mitolojisi*. Ankara: Türk Tarih Kurumu Basımevi.
- Özden, K. (2003). Tıp, Tarih, Mitoloji. Ankara: Ayraç Yayınevi.
- Özgür, S. (2006). Şamanizm ve Can Göknil Yapıtlarındaki İzdüşümleri. Yüksek Lisans Tezi. İstanbul: İstanbul Üniversitesi Sosyal Bilimler Enstitüsü Sanat Tarihi Anabilim Dalı.
- Şenses, R. O. (2001). Türk Halk Kültüründe Bolluk ve Bereketle ilgili inanç ve Uygulamarda Eski Türk Kültürü İzler. *Folklor Edebiyat* , 209/228.
- Tökel, D. A. (1998). Divan Şiirinde Mitolojik Ve Efsânevi Şahıslar. Samsun Ondokuz Mayıs Üniveristesesi, Doktora Tezi
- Vural, F. (2018). Kocaeli ve Sakarya Türkülerinde Motifsel Nitelik Taşıyan Çiçek, Hayvan, Renk Unsurlarının Türk Mitolojisi ve Türk Sanatındaki Yeri. *Uluslararası Çoban Mustafa Paşa ve Kocaeli Tarihi- Kültürü Sempozyumu-4* (s. 1919/1928). Kocaeli: Kocaeli Büyükşehir Belediyesi.
- Yayan, G. ve Kılıç, A. (2014). Kahramanmaraş Sandıklarında Kullanılan Motif ve Sembollerin Dili, Ankara, Öncü Basımevi s.(46-47-48)
- Yılmaz, S. (2014). Türk Mitolojisinde Bilgelik Kavramı. *Türk Dünyası Bilgeler Zirvesi: Gönül Sultanları Buluşması* (s. 231-249). Eskişehir: Türk Dünyası Kültür Başkenti Ajansı.



“

## Chapter 24

**NONLINEAR CANONICAL CORRELATION  
ANALYSIS AND AN APPLICATION ON  
SOCIAL INSTITUTION AND GENDER  
INDEX**

*Dilek VEYSİKARANI<sup>1</sup>  
Çiğdem KOŞAR TAŞ<sup>2</sup>  
Sibel ÖRK ÖZEL<sup>3</sup>*

”

1 Arş. Gör., Çukurova Üniversitesi, İİBF, e-posta: dilek.veysikarani@gmail.com, <https://orcid.org/0000-0001-8071-0720>.

2 Dr. Arş. Gör., Çukurova Üniversitesi, İİBF, e-posta: ckosar@cu.edu.tr, <https://orcid.org/0000-0001-8996-3556>.

3 Dr. Arş. Gör., Çukurova Üniversitesi, İİBF, e-posta: sork@cu.edu.tr, <https://orcid.org/0000-0002-7030-3512>.

## 1. Introduction

The term of equality has been a value and principle that concerns individuals and societies since the existence of humanity (Gozutok, Toraman and Acar-Erdol, 2017, p. 1037). The term of gender, on the other hand, refers to the social structuring of qualities belonging to men and women, such as roles, norms and relations between women and men groups. The gender equality is accepted as a main human right, as stated in international documents, conventions and undertakings (Kasikirik and Gulumser, 2021, p. 19). As the World Health Organization (WHO) states, the term of gender refers to the social structuring of attributes such as men and women's roles, relations and norms between groups of women and men.

The gender has also changed over time and changed from culture to culture. While individuals accomplish their roles in society, they also treat according to the value judgements that the social structure gives them. Although the gender roles assigned to men and women differ across cultures, men everywhere enjoy privileges. This demonstrates the existence of a number of common causes behind gender inequalities. Causality chains are difficult to establish and complex. This situation makes it difficult to explain gender inequality and its permanence (Ferrant, 2015, p. 314).

The gender discrimination is seen as an important element of the stratification system on society (Sullivan, 2003, p. 224). With the emergence of the gender discrimination, inequality in economic, political and cultural fields has emerged between men and women (Ridgeway, 2011, p. 9). In this context, the gender inequality states that the concepts of power, wealth and prestige are seen as an indicator of superiority between the two sexes and that men have the right to dominate over women. Attitudes that cause male domination lead to the existence of institutions that create and reinforce gender inequality in society (Metin Acer and Kurt Topuz, 2022, p. 127). Gender inequalities not only harm women exposed to inequality, but they also mean high costs to society and hinder overall development (Branisa, Klasen, and Ziegler, 2009, p. 3).

This gender discrimination against women causes women to stay in the background in both work and home life, and this negative situation brings about negative effects on many issues such as health and education. The lack of the concept of education, which is accepted as one of the indicators of development, poses a problem for countries (Yildirim and Eker, 2018, p. 509).

Various indices have been created to measure gender inequality, which is seen as one of the development important indicators, to determine gender roles and to ensure the empowerment of women. Some of these

indices are as follows: Gender Empowerment Index (GEM) and Gender Inequality Index (GDI) developed by the United Nations Development Program, Gender Equity Index (GEI) developed by Social Watch, the Social Institutions and Gender Index (SIGI) created by the Organization for Economic Co-operation and Development (OECD) and Global Gender Gap Index (GGI) developed by the World Economic Forum. Among these indices, SIGI includes discriminatory social institutions that focus on four dimensions and affect women's lives, as well as covering socio-economic areas. The four sub-dimensions at issue are restricted physical integrity, discrimination in the family, restricted civil liberties, and restricted access to productive and financial resources (Karakas and Cevik, 2016; Kosar Tas, 2021).

In this respect, in this study, data belonging to the sub-dimensions of discrimination in the family and restricted access to productive and financial resources dimensions of SIGI is used in order to evaluate the discrimination against women. In this study, the sample group consists of selected MENA countries, which are middle-income countries and have a complex region. In addition, it is aimed to determine the predicted relationships between two dimensions and variables of the dimensions by using nonlinear canonical correlation analysis (NLCCA) in this study. The existence of the relationships obtained by the chi-square independence test is supported. The fact that Middle East and North Africa (MENA) countries are behind in many aspects compared to developed countries is thought to contribute to the studies in this field by the country group selected on the issue of discrimination against women.

The remainder of the study is organized as follows: Section two consists of literature review relevant the gender equality and discrimination against women. In section three, there is the material and method part. In this section, SIGI is explained in detail and then the analysis method used in the study and the data set of the study are mentioned. Section four includes result of analysis. Section five concludes the paper.

## **2. Literature**

When the national and international literature is examined, it has been observed that there are many studies on equality and gender equality. On the other hand, it has been determined as a result of the literature research that there is very little field work on SIGI and indicators belonging to SIGI. Some literature reviews on the aforementioned concepts are given below.

Gupta and Sharma (2003) analyzed the problems experienced by female academics working in four institutes in India that teach and research

in science and technology in the face of gender inequality. In consequence of, they expressed that Indian female academics have disadvantages in India, because of India has a patriarchal structure, and the low number of female scientists causes male dominance.

Oztan (2004), who accepts positive discrimination as a functional institution in ensuring gender equality, revealed in her study that there is no discrimination policy with priority of opportunity in terms of providing gender equality in Turkey.

Dinc Kahraman (2010) aimed to determine women's views on gender inequality with a sample of 251 female participants. The data collected by the survey method were included in the analysis. As a consequence of the research, it has been discovered that gender inequality continues in very important issues such as women's educational opportunities, choosing a spouse in marriage and taking part in business life.

Ragins and Winkel (2011) put forwarded that the emotion patterns that men and women are expected to express in their working lives have differences. Although the anger levels of women are at the same level as men, they stated that women are seen as angrier and more unbalanced than men.

Branisa, Klasen, and Ziegler (2013), in their study of SIGI and its subcomponents for developing countries, examined how social institutions are related to concepts such as women's education level, child mortality and corruption. Using cross-country regression, the authors conclude that women in social institutions face higher inequality if they have lower education. In addition, they stated that when designing development policies based on gender in a country, it is necessary to consider how women are treated in the society, and thus it will have a positive effect on the social, economic and political functioning of the society.

Basar (2017) stated that the gender inequality directly or indirectly causes many health problems on women, such as nervous diseases and mental problems. This problem is experienced in Turkey and many countries according to different dimensions. The author emphasized that gender inequality should be combated, and countries should be sensitized.

Klasen (2018) stated that if gender inequality is eliminated, it causes a positive effect on GDP. In addition, the author revealed that reducing gender inequalities also requires higher economic performance. Baloch, Noor, Habibullah and Bani (2018) stated that if social inequality between men and women increases, income inequality will increase. The authors used the Generalized Method of Moments (GMM) analysis, including 103 countries for the period 2006-2013. Finally, it was

concluded that the narrowing of gender discrimination will contribute to income equality.

Yoon and Klasen (2018) analyzed SIGI for 100 non-OECD countries. They stated that high values of the index approach a high rate of gender inequality. Using principal components analysis and partial least squares method, they concluded that gender inequality has a significant correlation with corruption and fertility.

Fontanella, Sarra, and Di Zio (2019) used a Bayesian Structural Equation Model to consider suggested indicators in SIGI for 110 developing countries. The authors concluded that formal or informal gender discrimination reduces women's education and labor force participation rates.

Kosar Tas (2021), has classified Turkey and EU member countries according to SIGI's indicators with discriminant analysis. The author concluded that Turkey is not bad at discrimination against women and is close to EU member states.

Santos Silva and Klasen (2021), in their literature research, revealed that gender inequality is a major obstacle to social development in the long term. As a result of the literature research, women have a significant impact on the total economy with the role they play in fertility decisions and human capital investments.

Elveren and Mogdaham (2022) analyzed the Global Militarization Index and the Gender Inequality Index for 133 countries. In the related study, the authors investigated the effect of militarization on gender inequality using the data set for 1990-2017. As a consequence of the study, they detected that higher militarization leads to higher gender inequality. In addition, the results of the analysis have an important position in the sense of MENA countries and Muslim countries.

Perrin (2022) examined gender inequality in a historical perspective and tried to reveal its relationship with economic growth. It has developed an index covering the gender gap between women and men in three critical areas: education level, health and economic opportunities. In addition, the education of girls and boys and their family structures play an important role in determining gender equality.

Metin Acer and Kurt Topuz (2022) investigated the effect of the existing female parliamentarian ratio in the parliaments of the countries on the SIGI ranking with five different regression models. The authors concluded that the correlations of the female parliamentary ratio with the sub-dimensions of SIGI were significant.

### 3. Material and Method

One of the most complex regions in the world is “MENA”. MENA is an acronym in English, and it represents a group of countries located in regions Middle East and North Africa. There are about twenty countries in the region and these countries have many common and different characteristics in terms of political and socio-economic conditions (Kalayci, 2011, p. 176). Although the groundbreaking events in the MENA, usually called the Arab Spring, created great expectations for rights of women in that region and the world, significant changes did not occur in this sense. Women became empowered and at the same time excluded in the post-spring period. In addition, the patriarchal system remained intact or re-emerged in some new forms. Although some changes are observed in many traditional norms, the Middle East and North Africa region is still the least free region in the world. The ongoing instability in many MENA countries continues to threaten democratization, making the future of rights of women particularly uncertain (Darhour and Dahlerup, 2020, p. 2). In this context, it is very important to examine women's rights and the discrimination that women are exposed to in social institutions in this region and to present the findings.

The purpose of the study is to measure the relationship between restricted physical integrity sub-dimension and restricted access to productive and financial resources sub-dimension of SIGI with NLCCA. For this purpose, 23 selected MENA countries were included in the analysis. Since the latest report of SIGI belongs to 2019, the data set of this report was used in the study. The data of the variables were obtained from SIGI's website (<https://www.genderindex.org/>). Countries included in the analysis are Afghanistan, Algeria, Bahrain, Cyprus, Egypt, Iran, Iraq, Israel, Jordan, Kuwait, Lebanon, Libya, Morocco, Oman, Pakistan, Palestine, Qatar, Saudi Arabia, Sudan, Syrian Arab Republic, Tunisia, United Arab Emirates, and Yemen.

SIGI, which constitutes the data set of the study, and NLCCA, which is the method used, are explained below.

#### 3.1. Social Institutions and Gender Index

Published by the OECD Development Center, SIGI provides a measure of discrimination against women in social institutions in 180 countries. SIGI considers social norms, laws and practices and identifies the underlying causes of gender inequality to provide the data needed for policy change. SIGI has four sub-dimensions: (i) discrimination in the family, (ii) restricted physical integrity, (iii) restricted access to productive and financial resources and (iv) restricted civil liberties. Most of the



variables of SIGI and its sub-indexes take values of 0, 0.25, 0.5, 0.75, and 1. While 0 indicates that women and men have equal rights for the relevant variable, 1 indicates the highest discrimination against women and deprivation of women.

Four sub-dimensions of SIGI and 16 variables belonging to these dimensions are given in Figure 1.

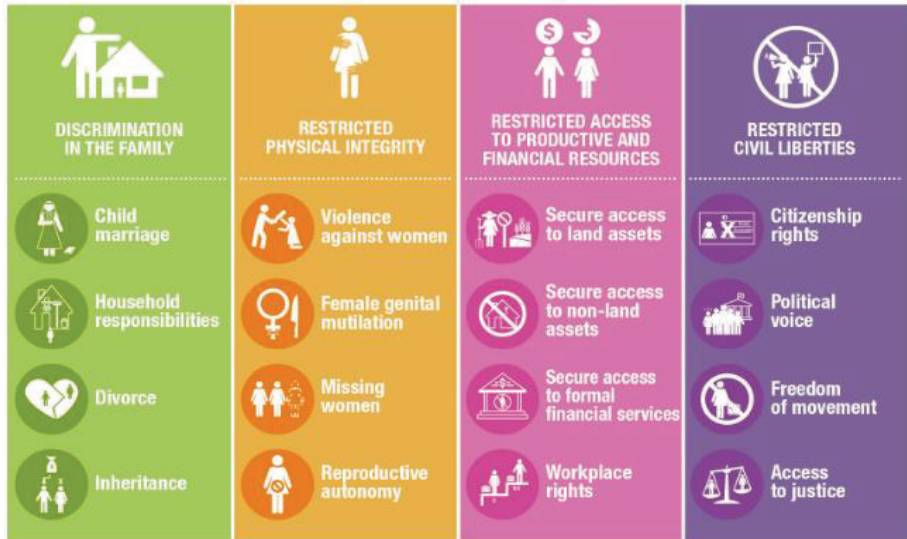

Figure 1. General structure of SIGI 2019. Retrieved October 14, 2022, from <https://www.genderindex.org/sigi/>.

The SIGI sub-dimensions to be used in the study are restricted physical integrity sub-dimension and restricted access to productive and financial resources sub-dimension. The variables and definitions of these sub-dimensions are given in Table 1 and Table 2.

Table 1  
 “Restricted Physical Integrity” and Its Variables

Sub Dimension	Variable	Category	Definition
<i>Restricted physical integrity</i>		Violence Against Women_0	Within the legal framework, women are protected from all forms of violence, including rape, partner violence, and sexual harassment, with no exceptions.
		Violence Against Women_0.25	Within the legal framework, women are protected from all forms of violence, including rape, partner violence, and sexual harassment, with no exceptions. But, the approach is not comprehensive.

<b>Violence Against Women</b>	Violence Against Women_0.5	Within the legal framework, women are protected from all forms of violence, including rape, partner violence, and sexual harassment. However, some legal exceptions arise in this category.
	Violence Against Women_0.75	Within the legal framework, women are protected from all forms of violence, including rape, partner violence, and sexual harassment but not all women.
	Violence Against Women_1	Within the legal framework, women are not protected from rape, partner violence, and sexual harassment
<b>Female Genital Mutilation (FGM)</b>	Female Genital Mutilation_0	Within the legal framework, women and girls are protected from FGM. Religious, customary and traditional practices and laws do not encourage FGM.
	Female Genital Mutilation_0.25	Within the legal framework, women and girls are protected from FGM. Some religious, customary, and traditional practices and laws encourage FGM, but laws take precedence over such religious, customary, and traditional laws or practices.
	Female Genital Mutilation_0.5	Within the legal framework, women and girls are protected from FGM. Some religious, customary, and traditional practices and laws encourage FGM, but laws don't take precedence over such religious, customary, and traditional laws or practices.
	Female Genital Mutilation_0.75	Within the legal framework, women and girls are protected from FGM, but does not impose criminal penalties for the enforcers of FGM.
	Female Genital Mutilation_1	Within the legal framework, women and girls are not protected from FGM.
<b>Missing Women</b>	Sex ratio among 0-4 year-olds (number of males per 100 females)	Sex ratio (number of males per 100 females) for the age group 0-4.
<b>Reproductive Autonomy</b>	Reproductive Autonomy_0	Within the legal framework, rights of women and reproductive health are protected in case of an unwanted pregnancy without asking for any justification.
	Reproductive Autonomy_0.25	Within the legal framework, rights of women and reproductive health are protected in case of an unwanted pregnancy, but asks for justification.
	Reproductive Autonomy_1	Within the legal framework, rights of women and reproductive health are only protected in case of an unwanted pregnancy with some justifications.

Autonomy_0.5	
Reproductive Autonomy_0.75	Within the legal framework, rights of women and reproductive health are only protected in case of an unwanted pregnancy with strict justifications
Reproductive Autonomy_1	Within the legal framework, rights of women and reproductive health are not protected in case of an unwanted pregnancy

Social Instutions & Gender Index. Retrieved October 13, 2022, from <https://www.genderindex.org/methodology/>.

Table 2  
*“Restricted Access to Productive and Financial Resources” and Its Variables*

Sub Dimension	Variable	Category	Definition
<i>Restricted access to productive and financial resources</i>	<b>Secure Access to Land</b>	Secure Access to Land_0	Men and women have the equal legal rights and secure access to land assets. Customary and religious practices or laws do not discriminate against women's legal rights.
		Secure Access to Land_0.25	Men and women have the equal legal rights and secure access to land assets. However, some traditional and religious laws and practices discriminate against women's legal rights.
		Secure Access to Land_0.5	Men and women have the equal legal rights and secure access to land assets. However, this is not for all groups of women.
		Secure Access to Land_0.75	Men and women have the equal legal rights to own land assets but they cannot use their land assets as collateral and make decisions.
		Secure Access to Land_1	Men and women do not have the equal legal rights to own land assets.
	<b>Secure Access to Non-Land Assets</b>	Secure Access to Non-Land Assets_0	Men and women have the equal legal rights and secure access to non-land assets. Religious and customary practices or laws do not discriminate against women's legal rights.
		Secure Access to Non-Land Assets_0.25	Men and women have the equal legal rights and secure access to non-land assets. However, some traditional and religious practices or laws discriminate against women's legal rights.
		Secure Access to Non-Land Assets_0.5	Men and women have the equal legal rights and secure access to non-land assets. However, this is not for all groups of women.

<b>Non-Land Assets</b>	Secure Access to Non-Land Assets_0.75	Men and women have the equal legal rights to own non-land assets but they cannot use their land assets as collateral and make decisions.
	Secure Access to Non-Land Assets_1	Men and women do not have the equal legal rights to own non-land assets.
<b>Secure Access to Formal Financial Services</b>	Secure Access to Formal Financial Services_0	Men and women have the equal rights to open a bank account and obtain a loan at an official financial institution. Religious and customary laws or practices do not discriminate against women's legal rights.
	Secure Access to Formal Financial Services_0.25	Men and women have the equal rights to open a bank account and obtain a loan at an official financial institution. However, some religious or traditional practices or laws discriminate against women's legal rights.
	Secure Access to Formal Financial Services_0.5	Men and women have the equal rights to open a bank account and obtain a loan at an official financial institution. However, this is not for all groups of women.
	Secure Access to Formal Financial Services_0.75	Men and women have the equal rights to open a bank account at an official financial institution. However, women and men do not have the same rights to receive loans.
	Secure Access to Formal Financial Services_1	Men and women do not have the equal legal rights to open a bank account at a formal financial institution.
<b>Workplace Rights</b>	Workplace Rights_0	In the legal framework, women and men are equal in the workplaces. Parental leave is available for both fathers and mothers, and the law protects women's rights during pregnancy period and parental/maternity leaves. Religious and customary laws or practices do not discriminate against women's legal rights to establish a business, enter certain professions, or choose a profession.
	Workplace Rights_0.25	In the legal framework, men and women are equal in the workplaces. Parental leave is available for both fathers and mothers, and the law protects rights of women during pregnancy period and parental/maternity leaves. However, there are religious or customary practices or laws that discriminate against women's legal rights to establish a business, enter certain professions, and choose a profession.
	Workplace Rights_0.5	In the legal framework, men and women are equal in the workplaces. Parental leave is available for both fathers and mothers, and the law protects rights of

	women during pregnancy period and parental/maternity leaves. However, this is not for all women groups.
Workplace Rights_0.75	In the legal framework, men and women are equal in the workplaces. Parental leave isn't available for both fathers and mothers, and the law doesn't protects rights of women during pregnancy period and parental/maternity leaves.
Workplace Rights_1	The legal framework doesn't guarantee the equality between men and women in workplaces.

Social Instutions & Gender Index. Retrieved October 13, 2022, from <https://www.genderindex.org/methodology/>.

The missing women variable under restricted physical integrity sub-dimension is not defined as categorical, so it is not suitable for NLCCA. Therefore, it is not included in the analysis. Moreover, since the categories for the workplace rights variable under the restricted access to productive and financial resources sub-dimension take a value of 1 for all countries in the study, it is considered that it would not be an important distinction to include this variable in the analysis. Therefore, this variable is not included in the analysis. In this context, analysis is carried out with 3 variables (female genital mutilation, violence against women, and reproductive autonomy) belonging to restricted physical integrity sub-dimension and 3 variables (secure access to land, secure access to formal financial services, and secure access to non-land assets) belonging to restricted access to productive and financial resources sub-dimension.

Table 3 shows the variable sets and categories for two sub-dimensions of SIGI used in the analysis.

Table 2

*Variable Set and Categories*

Sub Dimension	Variable	Category	Sub Dimension	Variable	Category
<i>Restricted physical integrity</i>		Violence Against Women_0	<i>Restricted access to productive and financial resources</i>		Secure Access to Land_0
		Violence Against Women_0.25			Secure Access to Land_0.25
		Violence Against Women_0.5		<b>Secure Access</b>	Secure Access to Land_0.5

<b>Violence Against Women</b>	Violence Against Women_0.75	<b>to Land</b>	Secure Access to Land_0.75
	Violence Against Women_1		Secure Access to Land_1
<b>Female Genital Mutilation</b>	Female Genital Mutilation_0		Secure Access to Non-Land Assets_0
	Female Genital Mutilation_0.25		Secure Access to Non-Land Assets_0.25
	Female Genital Mutilation_0.5	<b>Secure Access to Non-Land Assets</b>	Secure Access to Non-Land Assets_0.5
	Female Genital Mutilation_0.75		Secure Access to Non-Land Assets_0.75
	Female Genital Mutilation_1		Secure Access to Non-Land Assets_1
<b>Reproductive and Autonomy</b>	Reproductive Autonomy_0		Secure Access to Formal Financial Services_0
	Reproductive Autonomy_0.25	<b>Secure Access to Formal Financial Services</b>	Secure Access to Formal Financial Services_0.25
	Reproductive Autonomy_0.5		Secure Access to Formal Financial Services_0.5
	Reproductive Autonomy_0.75		Secure Access to Formal Financial Services_0.75
	Reproductive Autonomy_1		Secure Access to Formal Financial Services_1

Social Institutions & Gender Index. Retrieved October 13, 2022, from <https://www.genderindex.org/methodology/>.

### 3.2. Nonlinear Canonical Correlation Analysis

Principal Component Analysis (PCA) is generally used to search for a set of variables with and without covariates. In this method, the original variables are replaced by a set of new variables named principal components. Thanks to these components, the maximum variation between the original variables is taken into account. Hotelling (1936), suggested Canonical Correlation Analysis (CCA) as a generalization of PCA (Timm, 2002, p. 477).

CCA, a multivariate data analysis technique, is used to determine the relative modes between  $x$  and  $y$  for two variable sets  $x$  and  $y$ , taking into account linear combinations as follows:

$$u = a.x \text{ and } v = b.y \quad (1)$$

Where  $u$  and  $v$  canonical variates with maximum correlation. That is, the weight vectors  $a$  and  $b$  are selected to maximize the correlation coefficient between  $u$  and  $v$  (Wu and Hsieh, 2002, p. 713). CCA, a data reduction method, can be used to determine whether two sets of variables are independent under the assumption of multivariate normality. Given a large number of variables, canonical variates are used to examine and reconstruct the interrelationships between variables (Timm, 2002, p. 477). CCA has been applied to many learning tasks such as dimension reduction, data fusion, and classification (Shen, 2020, p. 1).

CCA is applied to metric variables. In this method, the assumption of multivariate normal distribution needs to be met. However, in the analysis of survey data, and especially in the field of social sciences, in many cases these assumptions cannot be met. Therefore, a different procedure for non-metric variable sets, NLCCA, in which categories are transformed to quantitative values, is proposed (Grzeskowiak, 2016, p. 64).

NLCCA, which is proposed by Gifi in the 1980s, can be considered as categorical canonical correlation analysis. This procedure considers categorical variables. NLCCA is also known by the abbreviation OVERALS in the literature (IBM SPSS Categories 28). This algorithm, in which variables are converted from qualitative variables to quantitative variables, is also called "optimal scaling" (Grzeskowiak, 2016, p. 64). The optimal scaling approach extends the standard approach, allowing more than two sets of variables to be used. In this method, variables can be scaled nominally, ordinally or numerically (IBM SPSS Categories 28). Only the order of the categories is considered for ordinal data, and only the classes

of objects for nominal data (Van der Burg, de Leeuw, and Dijksterhuis, 1994, p. 142). As a result of this, nonlinear relationship between the variables can be examined and analyzed.

According to Gifi terminology, Linear Canonical Correlation Analysis (LCCA) can be expressed with the following loss function under the constraints  $X'X = nI$  and  $u'x = 0$  (Van der Burg, et al., 1994; Giray, 2011; Filiz and Kolukisaoglu 2012; Akturk, 2015; Thanoon, Adnan, and Saffari, 2015; Altintas, 2021):

$$\sigma_m(X, A) = K^{-1} \sum_k SSQ(X - H_k A_k) \quad (2)$$

where

$X$ : is  $(n \times p)$  of object scores ( $n$  and  $p$  are the number of objects and dimensions respectively)

$SSQ(.)$ : the sum of squares of the diagonal elements of the vector or matrix

$K$ : is the number of sets

$m$ : is the total number of variables

$H_k$ : is an  $(n \times j_k)$  matrix containing scaled variables within set  $k$  ( $j_k$ : is the number of variables in set  $k$ )

$A_k$ : is an  $(j_k \times p)$  matrix of canonical weights of the variables in set  $k$

In NLCCA, indicator matrix  $G_j$  should be used instead of  $H_k$  matrix and  $Y_j$  category digitizations matrix should be used instead of  $A_k$  weights, since in qualitative data analysis the indicator matrix is employed instead of the original matrix of data. In this case, the loss function (Van der Burg, et al., 1994; Giray, 2011; Filiz and Kolukisaoglu, 2012; Akturk, 2015; Thanoon, Adnan, and Saffari, 2015; Altintas, 2021):

$$\sigma_m(X, Y) = K^{-1} \sum_k SSQ(X - \sum_{j \in J_k} G_{kj} Y_j) \quad (3)$$

where  $X$ ,  $SSQ(.)$ ,  $K$ , and  $m$  are as in Eq. (2),

$J_k$ : is the number of variables in set  $k$

$G_j$ : is an  $(n \times k_j)$  indicator matrix for variable  $j$  ( $j=1, \dots, m$ )

$Y_j$ : is an  $(k_j \times p)$  category digitizations matrix

With Alternating Least Squares (ALS), this loss function is minimized under the constraints  $x'X = nI$ ,  $u'x = 0$  and for some variables:  $Y_j = y_j a_j'$ ,  $G_j y_j \in C_j$

Where

$y_j$  = Single category digitizations  $(k_j \times p)$



$a_j$  = Canonical weights (p x 1)

$C_j$  defines the set of nominals, ordinal, or numeric conversions that fit the variable  $h_j$ .

In summary, NLCCA can be expressed as an optimization problem that minimizes the loss function under certain constraints. NLCCA will be the same as Generalized Canonical Correlation Analysis (GCCA) if all variables are numeric (Bulbul and Giray, 2011, pp. 116-117).

#### 4. Findings

In this study, NLCCA is applied to investigate the relationships between the variable sets of the discrimination in the family and restricted access to productive and financial resources dimensions, which are two of the four sub-dimensions of SIGI. Data analysis for three variables of each sub-dimensions performed using SPSS version 22.0. In this section, the findings obtained from the analysis are presented.

Firstly, a small difference value is obtained from the cut-off point as a result of 50 iterations, and it is seen that convergence is achieved and the loss function is minimized after 50 iterations. Eigenvalues, loss values, and fit value to show the similarities between sets are presented in Table 4. The fit and loss values in the table show how well the OVERALS solution is the optimal solution and fits the data according to the relationship among variable sets (Yazici, Ogus, Ankarali, and Gurbuz, 2010, p. 506).

Table 4  
*Solution Results*

		Dimensions		Sum
		1	2	
Loss	Set 1	0.051	0.186	0.237
	Set 2	0.057	0.198	0.254
	Mean of sets	0.054	0.192	0.246
Eigenvalue		0.946	0.808	
Fit				1.754

It is seen that the missing values for the first set are 0.051 in the first dimension and 0.186 in the second dimension. Similarly, these values are 0.057 and 0.198 for the second set, respectively. It is understood that the analysis is quite successful, since the missing values show the rate of

variance that cannot be explained by the canonical variable score. The value of 0.246, which is the sum of the mean loss values in each dimension, gives the sum of unexplained variation. Also, the fit value obtained in the study is 1.754 (2-0.246). Fit value shows sum of explained variation and it can take a maximum value of 2 because of dimension. So, this value obtained is quite good for analysis. Moreover, eigenvalues are a measure of fit value. So, eigenvalues sign the level of relationship shown by each dimension. It is seen that the eigenvalues are  $\lambda=0.946$  (1-0.054) in the first dimension and  $\lambda=0.808$  (1-0.192) in the second dimension. Considering that the eigenvalue statistic can take a maximum value of 1, it is seen that the eigenvalues obtained in the analysis are quite high.

We calculated canonical correlation coefficient using  $\rho_C = \frac{(Set\ number * \lambda) - 1}{Set\ number - 1}$  (Ozkan, 2019, p. 399) and  $\rho_C$  for both sets is obtained as 0.892 and 0.616, respectively. It is understood from the obtained canonical correlation coefficient values that the relationship between the two sets in the first dimension is quite good while it is good for the second set.

Weights used to obtain the canonical variables and show the contribution of the variables to the fit value (Filiz and Kolukisaoglu, 2015, p. 252). Weights are pointed out in Table 5.

Table 5  
*OVERALS Weights*

Sets	Variables	Dimensions	
		1	2
Set 1	Violance against women	-0.078	-1.049
	Female genital mutilation	0.906	-0.230
	Reproductive autonomy	0.453	0.575
Set 2	Secure access to land assets	-1.253	0.849
	Access to non-land assets	-0.157	-2.492
	Secure access to formal financial services	0.997	1.837

When Table 5 is examined, female genital mutilation (0.906) in the first set and secure access to land assets (-1.253) in the second set are the variables that contribute the most to the fit value of the first dimension. Violance against women (-1.049) in the first set and access to non-land assets (-2.492) variable in the second set are the variables that contribute the most to the fit value of the second dimension.

Component loadings presented in Table 6. This table give the correlations between optimal scaled variables and object scores (Yazici, et al., 2010, p. 508). Here, the absolute values of loadings should be checked. The variable with the highest loading is the most important variable in the solution (Bulbul and Giray, 2011, p. 118).

Table 6  
*OVERALS Loadings*

Sets	Variables	Dimensions	
		1	2
<b>Set 1</b>	Violence against women	-0.020	-0.725
	Female genital mutilation	0.879	-0.087
	Reproductive autonomy	0.334	0.068
<b>Set 2</b>	Secure access to land assets	-0.707	0.137
	Access to non-land assets	-0.227	-0.171
	Secure access to formal financial services	0.019	0.133

When Table 6 is examined, the highest correlations for the first set in the first and second dimensions belong to the female genital mutilation and violence against women, respectively. The highest correlations for the second set in the both dimension belong to the secure access to land assets.

The graphical representation of the component loads is presented in Figure 2. The shadow coordinates of the variables, called component loadings, correspond to the correlation between the transformed variables and the object scores. The further the variables seen in the component loading plot are from the origin, the more important that variable is for the analysis. In the absence of missing data, component loadings yield equivalent results to correlations between object scores and quantitative variables. In other words, it allows to see the relationship between the variables. The distances from the origin to each variable point estimate the significance of that variable (Ozkan, 2019, p. 403).

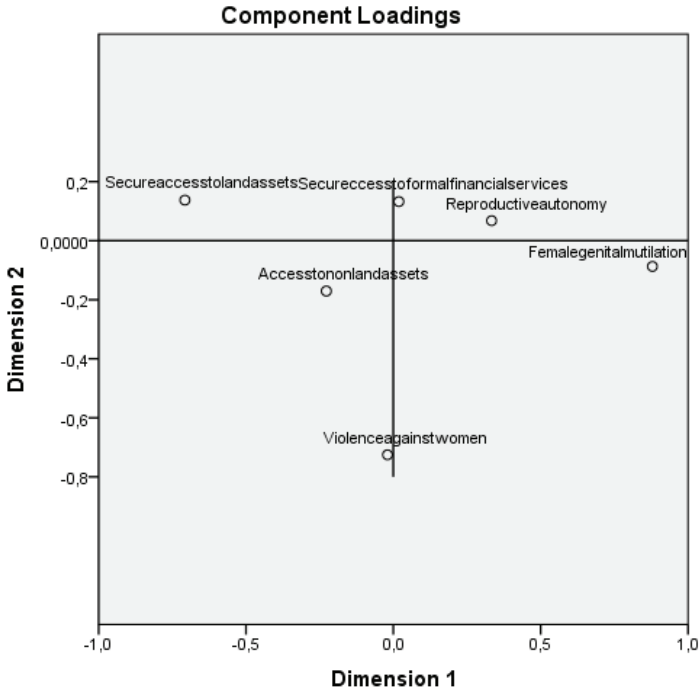

Figure 2. Component loadings

When Figure 2 is examined, it is clearly seen that female genital mutilation, violence against women and secure access to land assets are the variables farthest from the origin. The comments made in Table 6 are also supported by Figure 2.

Multiple and single fit values are given in Table 7.

Table 7  
Multiple and Single Fit Values

Set s	Variables	Multiple Fit			Single Fit			Single Loss		
		Dimensions		Sum	Dimensions		Sum	Dimensions		Sum
		1	2		1	2		1	2	
Set 1	Violence against women	0.00	1.09	1.10	0.00	1.09	1.10	0.00	0.00	0.00
	Female genital mutilation	0.82	0.05	0.87	0.82	0.05	0.87	0.00	0.00	0.00

	Reproductive autonomy	0.23 0	0.34 3	0.57 3	0.20 5	0.33 0	0.53 5	0.02 5	0.01 3	0.03 8
<b>Set 2</b>	Secure access to land assets	1.57 0	0.72 2	2.29 1	1.56 9	0.72 1	2.29 0	0.00 0	0.00 1	0.00 1
	Access to non-land assets	0.02 6	6.21 1	6.23 7	0.02 5	6.21 1	6.23 6	0.00 1	0.00 0	0.00 1
	Secure access to formal financial services	0.99 7	3.37 4	4.37 0	0.99 5	3.37 3	4.36 8	0.00 2	0.00 0	0.00 2

While evaluating this table, it is decided whether a change will be made in the scale levels of the single and multiple loss columns according to the values in the sum column. If there are large differences between the sum of single and multiple loss values, the single nominal variable should be made multiple nominal (Ozkan, 2019, p. 404). In this study, no difference is found between single and multiple fit values. Therefore, the scale used has not been changed. Also, the important variables for the analysis can be seen from the sum of multiple fit column (Filiz and Kolukisaoglu, 2015, p. 253). It is seen that violence against women at the first dimension and access to non-land assets at the second dimension are the most important variables.

Graphical representation of centroids are given in Figure 3. This plot helps to identify variables that have a high correlation between them.

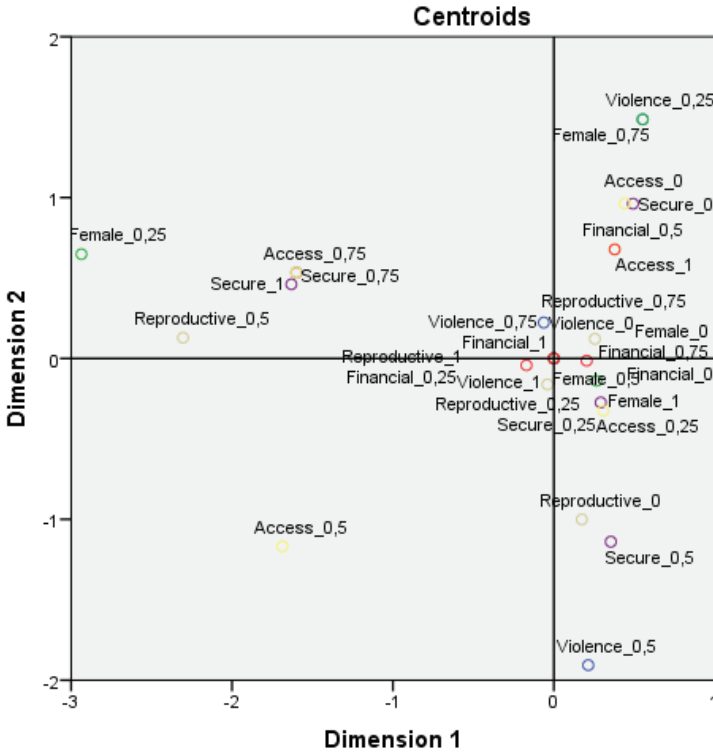

*Figure 3. Centroids plot*

Some of the relationships between the variables based on this plot are as follows:

- If the law protects women from all kinds of violence, including sexual harassment, rape and violence by intimate partners, men and women have the equal rights to open a bank account in this society. However, women and men do not have the equal rights to obtain loans.
- In societies where female genital mutilation is practiced, women do not have the equal rights as men to enter land nor non-land. In some societies, although men and women appear to have the same rights in the law, women cannot use these rights and cannot make decisions. There is no secure access to the land and non-land for women.
- In societies where laws do not protect reproductive health and rights of women in unwanted pregnancies, traditional and religious practices discriminate against legal rights of women. However,

women and men have the equal rights in financial matters such as opening a bank account.

- In societies where the percentage of women between the ages of 15-49 who hear about FGM and think that the practice should continue, women do not have equal rights with men in laws such as access to land and financial rights. Although they sometimes have equal rights before the law, they do not have equal rights in practice.

## 5. Discussion and Results

SIGI, which is an index designed to measure the level of discrimination in social institutions and gender equality, consists of four sub-dimensions. These dimensions are restricted physical integrity, restricted civil liberties, restricted access to productive and financial resources, and discrimination in the family.

In the study, we selected restricted access to productive and financial resources and restricted physical integrity. We used three variables from these dimensions. We examined the relationship between the sub-dimensions considered using these variables for selected MENA countries. Most of the MENA countries, which make up 6% of the world's population, are far from modernity. Therefore, it is possible that there is discrimination against women. We selected this country group because of this reason and applied NLCCA as a method.

Firstly, we obtained eigenvalue that are quite high. Also, we calculated a small mean loss value. This result shows the success of the analysis. After that, we observed that the relationship between restricted access to productive and financial resources and the restricted physical integrity dimensions are high thanks to the canonical correlation coefficient calculated. Later, we obtained violence against women and access to non-land assets are the most important variables using multiple and single fit values. Finally, we used centroids plot for observing relationships between the variables.

It is understood from the results of the analysis that unfortunately there is still gender inequality in this century. There are still some problems relevant female genital mutilation, violence against women and women's lack of reproductive autonomy in the world. In countries where these problems are high, there are simultaneous problems of unsafe access to non-land, land and formal financial services. In the countries discussed, the more women are subjected to violence by men, the more they are deprived of their rights, both the law and traditions. The fact that the MENA

countries, which are undeniably high in percentage, are far from modernity still causes these problems today.

The deprivation of women, who make up nearly half of the world's population, from the rights offered to men is one of the main reasons why countries cannot develop. One of the global goals for sustainable development is gender equality. It is of great importance for the Middle East and North Africa countries to make administrative reforms and raise public awareness in order to achieve this goal and develop.



## REFERENCES

- Akturk, D. (2015). Geleneksel ve organik olarak yetiştirilen tarım ürünlerine karşı tüketici taleplerinin doğrusal olmayan kanonik korelasyon analizi ile değerlendirilmesi [Evaluation of consumer demand against conventional and organic produced agricultural products with non-linear canonical correlation analysis]. *COMU Journal of Agriculture Faculty*, 3(1), 115-121.
- Altıntaş, F. F. (2021). Ekonomik özgürlük ile lojistik performans boyutları arasındaki ilişkinin doğrusal olmayan kanonik korelasyon ile ölçülmesi [Measuring the relationship between economic freedom and logistics performance dimensions by non-linear canonic correlation]. *EKEV Akademi Dergisi*, 25(86), 307-328.
- Baloch, A., Noor, Z. M., Habibullah, M. S., & Bani, N. Y. M. (2018). The effect of the gender equality on income inequality: A dynamic panel approach. *Jurnal Ekonomi Malaysia*, 52(2), 3-17.
- Basar F. (2017). Toplumsal cinsiyet eşitsizliği: Kadın sağlığına etkisi [Social gender inequality: Its effect on women's health]. *ACU Sağlık Bilimleri Dergisi*, 3, 131-137.
- Branisa, B., Klasen, S., & Ziegler, M. (2009). The construction of the Social Institutions and Gender Index (SIGI). *Working Paper* 184, Ibero-America Institute for Economic Research, Göttingen.
- Branisa, B., Klasen, S., & Ziegler, M. (2013). Gender inequality in social institutions and gendered development outcomes. *World Development*, 45, 252-268.
- Bulbul, S., & Giray, S. (2011). Sosyodemografik özellikler ile mutluluk algısı arasındaki ilişki yapısının analizi [Analysis of the relationship structure between socio-demographic features and happiness sensation]. *Ege Academic Review*, 11(special issue), 113-123.
- Darhour, H., & Dahlerup, D. (2020). *Double-edged politics on women's rights in the MENA region*. Cham, Switzerland: Palgrave Macmillan.
- Dinc Kahraman, S. (2010). Kadınların toplumsal cinsiyet eşitsizliğine yönelik görüşlerinin belirlenmesi [Determination of the opinions of women against social gender inequality]. *E-Journal of Dokuz Eylül University Nursing Faculty*, 3(1), 30-35.
- Elveren, A. Y., & Moghadam, V. M. (2022). Militarization and gender inequality: Exploring the impact. *Journal of Women, Politics & Policy*, 1-19.
- Ferrant, G. (2015). How do gender inequalities hinder development? Cross-country evidence. *Annals of Economics and Statistics*, 117/118, 313-352.

- Filiz, Z., & Kolukisaoglu, S. (2012). Doğrusal olmayan kanonik korelasyon analizi ve bir uygulama [Non-linear canonical correlation analysis and an application]. *International Journal of Management Economics and Business*, 8(16), 59-74.
- Filiz, Z., & Kolukisaoglu, S. (2015). Doğrusal olmayan kanonik korelasyon analizinin depresyon, anksiyete ve stres ölçeğine uygulanması [Nonlinear canonical correlation analysis' application on depression anxiety and stress scale]. *Journal of Administrative Sciences*, 13(26), 241-259.
- Fontanella, L., Sarra, A., & Di Zio, S. (2020). Do gender differences in social institutions matter in shaping gender equality in education and the labour market? Empirical evidence from developing countries. *Social Indicators Research*, 147, 133–158.
- Giray, S. (2011). *Doğrusal olmayan kanonik korelasyon analizi ve yaşam memnuniyeti üzerine bir uygulama [Nonlinear canonic correlation analysis and an application on life satisfaction]*. Doctoral dissertation, Marmara University, Istanbul.
- Gozutok, F. D., & Toraman, Ç. (2017). Toplumsal cinsiyet eşitliği ölçeğinin (TCEO) geliştirilmesi [Development of gender equality scale]. *Elementary Education Online*, 16(3), 1036-1048.
- Grzeskowiak, A. (2016). Satisfaction with chosen aspects of life in Poland - evaluation by canonical correlation methods. *International Journal of Social Sciences*, 1(1), 60-71.
- Gupta, N., & Sharma, A. K. (2003). Gender inequality in the work environment at institutes of higher learning in science and technology in India. *Work, Employment and Society*, 17(4), 597-616.
- Hotelling, H. (1936). Relations between two sets of variates. *Biometrika*, 28, 321–377.
- Kalaycı, I. (2011). Afrika'nın melez yüzü, 'MENA': Makro iktisadi göstergelere ve küresel endekslere göre 'manası' [Hybrid face of the Africa, 'MENA': 'Its sense' in respect of macroeconomic indexes]. *Eurasian Studies*, 40(2), 175-199.
- Karakas, B., & Cevik, O. C. (2016). Cinsiyet eşitsizliğinin ölçülmesi: Küresel Cinsiyet Uçurumu Endeksine eleştirel bir yaklaşım [Measurement of gender inequality: A critical approach to The Global Gender Gap Index]. *HAK-İŞ Uluslararası Emek ve Toplum Dergisi*, 5(13), 67-81.
- Kasikirik A., & Gulumser, I. (2021). Toplumsal cinsiyet eşitliğinin anayasalara ve uluslararası sözleşmelere yansımaları. *Turkish Journal of Policy Studies*, 1(1), 59-69.
- Klasen, S. (2018). The Impact of gender inequality on economic performance in developing countries. *Annual Review Resource Economics*, 10, 278–279.

- Kosar Tas, C. (2021). Kadınlara karşı ayrımcılığın Sosyal Kurumlar ve Cinsiyet Endeksi temelinde incelenmesi: Türkiye'nin AB üyesi ülkeler ile bazı Orta Doğu ülkelerine göre durumu [Examination of discrimination against women based on Social Institutions and Gender Index: the status of Turkey according to EU member and some Middle East countries]. *Erciyes University Journal of Faculty of Economics and Administrative Sciences*, (60), 161-187.
- Metin Acer, T., & Kurt Topuz, S. (2022). Kadın parlamenter oranlarının ülkelerin Sosyal Kurumlar ve Cinsiyet Endeksi (SIGI)'ndeki yerine etkisi [The ratio of women in national parliaments and its effect on Social Institutions and Gender Index (SIGI) rankings]. *Istanbul University Journal of Women's Studies*, 24, 123-137.
- Ozkan, M. (2019). Doğrusal olmayan kanonik korelasyon analizi ile seçilmiş demografik ve sosyo-kültürel kavramların değerlendirilmesi [Evaluation of selected demographic and socio-cultural concepts by nonlinear correlation analysis]. *Eskişehir Osmangazi University Journal of Economics and Administrative Sciences*, 14(2), 391-408.
- Oztan, E. (2004). Toplumsal cinsiyet eşitliği ve olumlu ayrımcılık [Gender equality policies and positive discrimination]. *Ankara University SBF Journal*, 59(1), 203-235.
- Perrin, F. (2022). Can the historical gender gap index deepen our understanding of economic development?. *Journal of demographic economics*, 88(3), 379-417.
- Ragins, B. R., & Winkel D. E. (2011). Gender, emotion, and power in work relationships. *Human Resource Management Review*, 21, 377-393.
- Ridgeway, C. L. (2011). *Framed by Gender: How gender inequality persists in the modern world*. New York: Oxford University Press. Crossref.
- Santos Silva, M., & Klasen, S. (2021). Gender inequality as a barrier to economic growth: a review of the theoretical literature. *Review of Economics of the Household*, 19(3), 581-614.
- Shen, Y. (2020). Differentially Private Nonlinear Canonical Correlation Analysis. *2020 IEEE 11th Sensor Array and Multichannel Signal Processing Workshop (SAM)*, 1-5.
- Sullivan, T. J. (2003). *Introduction to Social Problems*. Boston: Pearson Education.
- Thanoon, T. Y., Adnan, R., & Saffari, S. E. (2015). Generalized nonlinear canonical correlation analysis with ordered categorical and dichotomous data. *Jurnal Teknologi*, 75(1), 91-99.
- Timm, N. H. (2002). *Applied Multivariate Analysis*. New York: Springer-Verlag.
- Van Der Burg, E., De Leeuw, J., & Dijksterhuis, G. (1994). OVERALS: Nonlinear canonical correlation with k sets of variables. *Computational Statistics & Data Analysis*, 18(1), 141-163.

- Wu, A., & Hsieh, W. W. (2002). Nonlinear canonical correlation analysis of the tropical Pacific wind stress and sea surface temperature. *Climate Dynamics, 19*, 713-722.
- Yazici, A. C., Oğus, E., Ankaralı, H., & Gurbuz, F. (2010). An application of nonlinear canonical correlation analysis on medical data. *Turkish Journal of Medical Sciences, 40*(3), 503-510.
- Yıldırım, F., & Eker, H. (2018). Türkiye’de insani gelişmenin göstergesi olarak toplumsal cinsiyet eşitliği: Toplumsal cinsiyete duyarlı bütçeleme [Gender equality as human development indicator in Turkey: Gender sensitive budgeting]. *The Journal of International Social Research, 11*(8), 507-517.
- Yoon, J., & Klasen, S. (2018). An application of partial least squares to the construction of the Social Institutions and Gender Index (SIGI) and the Corruption Perception Index (CPI). *Social Indicators Research, 138*, 61–88.

### Internet References

- IBM SPSS Categories 28, Retrieved October 12, 2022 from, [https://www.ibm.com/docs/en/SSLVMB\\_28.0.0/pdf/IBM\\_SPSS\\_Categories.pdf](https://www.ibm.com/docs/en/SSLVMB_28.0.0/pdf/IBM_SPSS_Categories.pdf).
- Social Institutions & Gender Index, Retrieved October 13, 2022 from <https://www.genderindex.org/methodology/>.
- Retrieved October 13, 2022 from <https://stats.oecd.org/Index.aspx?DataSetCode=GIDDB2019>.
- WHO, Retrieved October 14, 2022 from <http://www.who.int/gender-equity-rights/understanding/gender-definition/en/>.

“

## Chapter 25

**INVESTIGATION OF FACTORS  
AFFECTING RELIGIOUS COPING IN  
THE PANDEMIC PROCESS: PERCEPTION  
OF SUBJECTIVE RELIGIOSITY,  
PRAYER, WORSHIP, AND SOME SOCIO-  
DEMOGRAPHIC FEATURES**

*Nurten KIMTER<sup>1</sup>*

”

---

<sup>1</sup> Assoc. Prof., Çanakkale Onsekiz Mart University, Theology Faculty, ORCID: 0000-0002-5736-719 , nurtenkimter@comu.edu.tr, Turkey

## INTRODUCTION

Humans, who face many problems throughout their lives, have to constantly struggle to overcome these problems, and therefore, life becomes a kind of struggle for them. In this respect, all the efforts made by people to overcome distressing and painful negative life events such as natural disasters, pandemics, wars, diseases, accidents, losses, and financial and familial problems faced in the life stage, which is a kind of struggle area, is called “coping”. The word “coping” is used in English to refer to the efforts of individuals to eliminate stress and anxiety. Coping, which was derived from the word “colpus” which means “to change” in Latin, is the condition in which a person can produce different solutions for negative life events (Okan & Ören, 2021:363). The first reaction of a person to a stressful situation may be “fight or flight”. When the biological changes occurring in the organism during a reaction to negative life events causing stress and anxiety are not kept under control, people can be physically or mentally harmed (Roskies, 1998: 32). In such a condition, people, who think that their bonds with life are jeopardized, try to regain the control they have lost and find meaning and solace by using several coping methods. Therefore, coping refers to all of the physical, cognitive, emotional, and behavioral efforts that people make to overcome the difficulties faced in life adventure, reduce tensions, and keep the situation under control (Lazarus, 1993: 238-239). In other words, coping means the effort spent to regulate negative emotions and regain lost meaning and control when faced with stress and worrisome events (Folkman & Moskowitz, 2004:747). Coping, in this sense, represents a process of change that enables people to actively participate in life and makes them healthy, strong, dynamic, and energetic under all conditions (Bahadır, 2002). The balance and harmony of people who face many physical, mental, and spiritual stimuli throughout life may be disrupted. Coping methods come into play when people want to regain the harmony and balance that were disrupted by giving meaning to the negative life events and trying to overcome them (Folkman & Moskowitz, 2004:747). The concept of coping was first brought into the agenda by Lazarus et al. in 1966, and it takes its source from ego psychology, developmental psychology, experimental psychology, and social psychology (Pargament, 2003:208-209) and prioritizes cognitive and behavioral elements in coping with stressful life events (Lazarus & Folkman, 1984:142). Coping, which also refers to an active process that requires making important decisions or making choices in difficult and challenging times, is a multidimensional phenomenon with physical, mental, emotional, and behavioral dimensions (Pargament, 1997:84-85). Therefore, according to Folkman and Lazarus, coping is an emotional and behavioral response to control environmental

and internal desires and conflicts and to reduce stress and tension (Folkman, Lazarus, Gruen & DeLongis, 1986). When people evaluate the life events they face as distressing and challenging for themselves, they make some attempts to cope with these events. In this sense, coping is a search for meaning that emerges in challenging times (Lazarus & Folkman, 1984: 90). In other words, coping is an effort to protect and transform the meaning put forward when material and spiritual things that have great importance and value in the life of individuals are damaged or jeopardized (Pargament & Rye, 1998: 60). The defense mechanisms and coping styles of Freud used to cope with stressful events or situations are different from each other. The most important difference between them is that the first involves unconscious processes and the second involves conscious activities (Atkinson, Atkinson, Smith, Bem & Hoeksema, 2010:512).

An individual who faces any life event first decides whether this event or situation is stressful or not. As a result of this primary evaluation, when the person decides that the event is stressful and negative, s/he also considers and evaluates how to cope with it and what resources s/he has at hand for coping. This is called secondary evaluation. Then, the individual engages in any or a few of the coping activities that s/he thinks will work in overcoming this stressful situation (Pargament, 1997: 96-98). As it is understood, coping with stress depends on both the personality of the individual and the characteristics of the stressful event (DeLonghis & Newth, 2001:145). Although the coping process involves several mental, emotional, and behavioral activities, mental activities such as perception, interpretation, evaluation, decision-making, and seeing the logical side of events are more prominent in this process. As a result, the stressful situation or event can be successfully taken under control by using appropriate coping techniques, but it can also be possible to fail in coping activities by using inappropriate and inadequate coping methods (Baltaş & Baltaş, 2012:27; Ekşi, 2001:17). For this reason, when determining the preferred coping method to cope with a negative life event, it is necessary to consider whether this method is suitable to solve the problem. Because basically, no coping method is positive or negative, beneficial or harmful on its own. Right at this point, whether or not the person uses the coping method required by the stressful life event determines whether or not the result is successful (Yöndem, 2002:43-47). It is seen in the literature that different coping styles such as problem-focused, emotion-focused, positive-negative, and active-passive are mentioned. In problem-focused coping, the purpose is to eliminate a stressful situation or event, to solve the problem, or to reduce its negative effects. On the other hand, emotion-focused coping involves controlling the negative emotions caused by the stressful situation and regulating the emotional reactions to the source of

stress. To summarize, emotion-focused coping helps to reduce stress and distress, but problem-focused coping helps to eliminate the stress-causing situation. Emotion-focused coping strategies also involve trying to see the positive side of the event, accepting the truth, and trying to forget everything, but problem-focused coping strategies include making a plan and putting it into action, resisting, and fighting for what is desired. It is possible to apply one of the problem or emotion-focused coping methods or both at the same time depending on the characteristics of the stressful situation and the personal characteristics of the individual. However, to talk about effective coping, both problem-focused and emotion-focused coping must be functional (Lazarus & Folkman, 1984: 141-151, 157; Sears, Peplau & Taylor, 2015: 465). In active coping strategies, individuals actively strive to eliminate the problem, passive coping strategies are a method in which individuals prefer to stay away from the sources of the problem that creates stress. It was reported in previous studies which were conducted to determine which active or passive coping strategy is more effective and correct in coping with stress, it was reported that it is more beneficial to use active coping strategies. Because, although using passive coping strategies is extremely beneficial in the short run, it can cause other problems in the long run (Burger, 2006:199-210).

Methods of coping with stressful negative life events can be religious or non-religious because when worldly life is considered a stage of struggle, it is not possible to disable religion as a phenomenon that has existed with human beings throughout history. It is a well-known fact that religious people with strong and sincere beliefs turn to their beliefs and values and seek help from the supreme and almighty being they believe in overcoming the troubles and difficulties they face in their struggle for life. It is seen that even people who did not have religious beliefs, in other words, non-religious, turn to religion by seeing religious beliefs and values as an alternative when non-religious methods do not work. Right at this point, religion becomes an important coping method for people with its reasonable, satisfactory, and convincing explanations (Karaca, 2011:111-112; Saral, 2013:44-45). For this reason, one of the coping strategies individuals use to cope with stressful life events is religious beliefs. In other words, a person who faces a negative life event can receive help from religious beliefs to eliminate this stress and painful situation and can use religious beliefs and practices as a coping method to cope with the stressful and problematic situation (Kula, 2002: 240-241). In this sense, although there are many coping strategies for people when faced with stressful negative life events, especially religious people can turn to religion and benefit from religious elements as a coping strategy in times of distress or crisis (Pargament, 1997: 166). In this way, the situation of



overcoming negativities by using religious instruments is called religious coping (Aytan, 2012:37-40). In other words, religious coping refers to making use of religious beliefs, values, and religious practices to cope with a problem or stress (Koenig, Pargament & Nielsen, 1998:513-521). According to Pargament (1997:90), when people are faced with stressful situations or negative life events, the beliefs they use in the struggle to cope are called religious coping (Pargament, 1997: 90). It is argued that most people use religious coping methods when faced with serious problems and negative life events in their lives, and these methods give more positive results than non-religious coping methods (Haque, 2012: 153). As a mental schema, religion provides a framework that will enable people to both perceive events and evaluate the events they perceive. Studies conducted previously in this context showed that religion, as a mental schema, makes a significant contribution to coping with stress of people (McIntosh, 1995). Pargament also drew attention to the positive effects of religion on problem-solving and argued that it has important functions such as giving hope, peace, and support to individuals, giving them a sense of purpose and meaning, helping to control events and establishing good relations with other people, and contributing to coping with negative life events. In this respect, religion, which has positive impacts on physical and mental health, constitutes a special reference source for individuals (Pargament, Kenneth I. et al., 1988: 91; Pargament, Smith, Koenig & Perez, 1998: 711). Right at this point, religious coping is a coping activity that includes receiving support from religious and spiritual values in overcoming negativities, troubles, and difficulties in life. Because religion performs important functions such as responding to people's search for meaning, gaining a sense of trust and control, comforting and curing, offering closeness and support, and helping to transform life by contributing to personal development in the coping process (Pargament, 1997: 234- 235, Pargament, Koenig & Perez, 2000: 521). For this reason, it is argued that religious coping activities have 5 basic religious functions which are; seeking meaning, seeking deep knowledge and control, seeking peace and connecting to God, seeking closeness and being close to God, and seeking to transform life (Pargament, Kenneth I. et al., 2000: 521).

As it is understood, religious coping is a process involving religious feelings, thoughts, practices, and objects with religious meaning, although not necessarily. However, religious experiences are not only lived when faced with stressful events in life, but religion is not merely a coping method (Pargament, 1997: 131-139). According to Pargament, religion has 3 aspects in the religious coping process. He argued that religion can either be a natural part of the coping process itself, contribute to the process directly or indirectly, or in some cases, be a product of the

coping process or transform the individual's belief (Pargament, Kenneth I. et al., 1990:796). In situations where people feel helpless when faced with extremely traumatic events such as natural disasters, pandemics, accidents, and death, religious elements such as belief in a powerful creator, optimism, hope, patience, gratitude, resignation, faith in fate, and the hereafter help people cope with negativities. They help to make sense of the event and to endure the stress, pain, and sadness of the problematic event. The use of religious coping helps people find meaning in experiences by giving the feeling that God will help in solving the problems faced in life. Also, with their religious beliefs, people can find solace and hope to a great extent by feeling emotional comfort and calmness in the process of religious coping, finding social support, reducing death anxiety, and seeking wisdom in the diseases and disasters they face (Cohen & Koenig, 2003: 226; Tarakeshwar, 2006: 646-657). Religious practices such as belief in Allah, the Hereafter, and destiny, the perception of the "test", patience, gratitude, *tawakkul*, and prayers are the main elements of religious coping. In this sense, it is stated that the most used religious coping activity was found to be prayer in previous studies (Topuz, 2003: 7-8). Generally, many people tend to pray and worship, especially when they face life difficulties such as illness, accident, war and earthquake, and death (Kula, 2005: 59). Religion, which has the potential to respond to the different needs of people, helps people in solving problems with its support in changing the perspective of events when it is impossible to change the facts, and giving patience by accepting the pain. For this reason, there are practical benefits of religious beliefs and worship when faced with difficulties in daily life (Cüceloğlu, 2001: 183). It is argued that religion also has an effect on providing mental and emotional support to the individual, especially in coping with stressful negative life events (Pargament, Kenneth I. et al., 1988:90). God, who is a safe haven and an ideal attachment figure with His unconditional love and forgiveness for His creatures, helps people to cope with negativities in life by providing a reliable basis in difficult and stressful life situations (Kirkpatrick, 1998: 970). Religion, which offers the most beautiful and special meaning and interpretation framework in his search, has a privileged position in the coping process. Using religious coping methods when people face a stressful event greatly reduces the stress level and acts as a buffer against the negative effects of stress (Ekşi, 2001:21, 51-52).

Researchers who dealt with religious coping mention two types of religious coping in general, positive and negative. According to Pargament (2005), positive religious coping involves a secure relationship with God, the idea that there is meaning in life, the seeking of spiritual support from God, a religious perspective that brings benefit in negative situations, the

seeking of support from the clergy or the members of the congregation, and the seeking of religious support to others as well as charity and religious pardon. Negative religious coping involves consideration of the problematic situations a punishment and refers to a weak relationship with God, a negative and bad worldview, questioning the power of God, expressions of rebellion and anger against God, dissatisfaction with the congregation and the clergy, negative life experiences in situations of distress and stress in life. In other words, positive religious coping involves a close relationship with the sacred, believing that suffering has a spiritual meaning, and establishing cooperation with God in solving problems. Negative religious coping is explained by some features such as spiritual disconnection, doubting the power and love of God, or excluding God from the problem-solving process (Güler Aydın, 2010: 98). In this context, it is seen that the styles of positive religious coping have sub-dimensions such as turning to God, seeing the silver lining in every cloud, religious supplication, religious intimacy, seeking religious direction and religious conversion. On the other hand, it is stated that negative religious coping strategies involve sub-dimensions such as spiritual discontent, attributing evil, and interpersonal religious discontent (Ayten, 2012: 89). Studies generally report that positive religious coping affects health status positively, and negative religious coping affects negatively (Pargament, Kenneth I. et al., 2004:713; Karataş, 2018; Murat, 2018). It was mentioned in previous studies that there are 3 different styles of religious coping. The first one is personal-oriented religious coping in which the person tries to cope with the problem without expecting any help from the God s/he believes in. The second is a religious coping style of leaving the decision to someone else or negative resignation. In this type of coping style, the person expects that God will intervene in the situation without making any effort to solve the problem. For this reason, people who adopt such a religious coping style refer to the solution of the problem to God instead of solving the problem. The third one is showing a tendency to solve problems by cooperating with God. In such a religious coping style, both the individual and God play active roles in solving the problem (Pargament, 2005:286; Ekşi, 2001:42). Three types of religious coping styles are mentioned in relation to the conceptions of God, in other words, to gain a sense of control in the religious coping process. In this respect, a person either sees himself/herself as sufficient in difficult and difficult times and tries to solve the problem, or leaves the solution to Allah completely, or tries to solve the problem in cooperation with Allah (Pargament, 1997:180-182) as a collaborative approach with God. For this reason, one of the religious coping styles, the personal-oriented coping style shows the active coping style of the individual and the divine power is at the lowest level, and the procrastinating style is the individual's waiting for the solution of the

problems from God by remaining passive when faced with the problem. On the other hand, the collaborative style expresses the situation of the individual coping with the problem actively by cooperating with God (Pargament & Park, 1997:47).

There are many factors affecting religion and religiosity, as well as several factors affecting religious coping styles. In this context, the religious coping process in which individuals benefit from religious beliefs can be influenced by several factors, such as values and practices in coping with negative life events that cause stress, gender, age, education and income status, place of residence, religiousness and subjective religiosity perception, prayer, and worship. Because the religious coping methods used by the person in coping with stressful situations can vary depending on a wide variety of factors such as age, gender, culture, and illness, it can be argued that religious coping styles have personal characteristics (Ağargün, M. Yücel et al., 2005). With the declaration of a pandemic by the World Health Organization on March 11, 2020, because of the rapid spread of the Covid-19 virus in all countries of the world, the physical and mental health conditions of people and societies were affected negatively. The findings obtained from many studies conducted during the pandemic period showed that painful extraordinary situations such as illness, material, and moral loss, isolation, and quarantine during this period caused psychological problems (Wang, Cuiyan, et al., 2020; Pillay & Barnes, 2020: 151; Galea, Merchant & Lurie, 2020: 817; Poyrazli and Can, 2020:67; Aslan, 2020:49-51). To cope with the negativities brought by the pandemic, it was seen in the research that there is an orientation toward religion in all people of the world and that religious coping methods are often used in addition to various coping activities in this process (Roman, Mthembu & Hoosen, 2020; Meza, 2020; Kalgi, 2021:116). In the present study, the factors that were effective in people's use of positive and negative religious coping methods during the pandemic process were examined. In other words, whether women or men, the elderly or the young, those with high or low levels of education and income, those living in small settlements or those living in urban centers used positive or negative religious coping styles more in the Covid-19 pandemic. It was also tried to uncover how effective people's perception of themselves as religious was along with the frequency of prayer and worship, and their use of positive and negative religious coping styles.

## **THE STUDY AND METHOD**

### **Purpose and Method**

The purpose of the present study was to examine the factors affecting the religious coping styles of individuals during the Covid-19 pandemic process. In this context, the effects of gender, age, income, educational

status, place of residence, subjective perception of religiosity, and frequency of prayer and worship on positive and negative religious coping styles were uncovered in the study. Ethics committee permissions were obtained before the study commenced, and the online survey technique was used to collect the raw data. The SPSS 25 package program was used in the analysis of the data collected in this quantitative study, which was conducted with the documentation and screening method.

### **Population and Sample**

The population of the study consisted of people over the age of 18 residing in different cities in our country, and the sample consisted of 243 women and 94 men who were determined voluntarily and by random sampling method.

### **Data Collection Tools**

The “Personal Information Form” and “Religious Coping Scale” were used as the data collection tools in the study.

### **Personal Information Form**

The Personal Information Form included questions to measure and record gender, age, income, educational status, marital status, place of residence for a long time, subjective perception of religiosity, and frequency of prayer and worship.

**Religious Coping Scale:** The “Religious Coping Scale” that was used in the data collection in the study was developed by Pargament et al. (1998). The adaptation study of this scale into Turkish was conducted by Ekşi and Sayın (2016). The first seven items (between 1-7) of the scale, which is prepared in a 10-item, 4-point Likert style consisting of two sub-dimensions, measure positive religious coping, and the last three items (range 8-10) measure negative religious coping. The fit index values calculated for the Religious Coping Scale as a result of Confirmatory Factor Analyses (CFA) ( $\chi^2/SD = 2.58$ ;  $RMSEA = .049$ ;  $SRMR = .20$ ;  $GFI = .94$ ;  $CFI = .95$ ;  $NFI = .98$ ;  $NNFI = .93$ ) was at an acceptable level, and the reliability coefficients that were calculated on the study data were high. In this respect, the Cronbach’s Alpha Value that was calculated for the positive religious coping dimension of the Religious Coping Scale was found to be ( $\alpha = .88$ ), and the Cronbach’s Alpha Value that was calculated for the negative religious coping dimension was calculated to be ( $\alpha = .89$ ).

### **The Hypotheses of the Study**

**H(1)** The socio-demographic variables such as gender, age, education, income, occupation, marital status, and place of residence are predictors of positive religious coping.

**H(2)** The subjective religiosity perception, prayer, and worshiping status of the participants are predictors of positive religious coping.

**H(3)** The socio-demographic variables such as gender, age, education, income, occupation, marital status, and place of residence are predictors of negative religious coping.

**H(4)** The subjective religiosity perception, prayer, and worshiping status of the participants are predictors of negative religious coping.

### **Analysis of Data**

The SPSS 25 package program was used in the analysis of the study data. Parametric tests were used in the study because the distribution of the data was normal (*Skewness*= .243 - 1.268; *Kurtosis*= -.059 - 1.854). Exploratory factor analysis, frequency distribution, arithmetic mean, correlation test, and regression analysis were used in the analysis of the raw data collected in the study.

## **RESULTS**

### **1. The Findings on the Socio-Demographic Factor**

A total of 72.1% ( $N=243$ ) of the people who participated in the study were female and 27.9% ( $N=94$ ) were male. The age range of the participants was between 18-75 years, 25.2% ( $N=85$ ) of them were between the ages of 46-55, 23.4% ( $N=79$ ) were between the ages of 36-45, 21.4% ( $N=72$ ) were between the ages of 26-35, 21.4% ( $N=72$ ) were between the ages of 18-25, 6.5% ( $N=22$ ) were between the ages of 56-65 and 2.1% ( $N=7$ ) were between 66-75. A large part of the sample, 77.2% ( $N=260$ ), was college/university graduates, 12.5% ( $N=42$ ) were high school graduates or equivalent, 6.5% primary school ( $N=22$ ) and 3.9% ( $N=13$ ) secondary school graduates. Also, 81.9% ( $N=276$ ) of the participants had moderate income levels, 12.5% ( $N=42$ ) had high income and 5.6% ( $N=19$ ) had low-income levels. Majority of the participants were residents of big cities (43.6%;  $N=147$ ) and city centers (40.7%,  $N=137$ ), 12.2% ( $N=41$ ) lived in towns and 3.6% ( $N=12$ ) were village residents. More than half of them ( $N=188$ ; 55.8%) considered themselves religious in terms of their subjective perception of religiosity, 20.2% ( $N=68$ ) highly religious, 16.3% ( $N=55$ ) somewhat religious, 4.2% ( $N=14$ ) and 3.6% ( $N=12$ ) perceived them as very religious. More than half of the sample (59.1%,  $N=199$ ) worshiped regularly, 17.5% ( $N=59$ ) frequently, 18.7% ( $N=63$ ) occasionally, and 3.9% ( $N=13$ ) stated that they did not worship much, and 0.9% ( $N=3$ ) stated that they did not worship at all. Similarly, most of the participants prayed frequently and regularly (89.6%,  $N=302$ ), 8.6% ( $N=29$ ) stated that they prayed occasionally, and a very few (1.8%,  $N=6$ ) stated that they never prayed.



## 2. The Findings on the Relationships Between Demographic Characteristics and Religious Coping Levels of the Participants (Regression Analyzes)

The multiple regression analysis was performed in the study to determine how much gender, age, income, education level, place of residence, subjective perception of religiosity, and frequency of prayer and worship predicted positive and negative religious coping and the findings are shown in Table 1 and Table 2.

**Table 1.** Predictors of Positive Religious Coping (Enter Multiple Regression Analysis)

Variables	$\beta$	Stand. Er.	$\beta$	t	p	Paired r	Partial r
Constant (Post. Rel. Cop.)	1.807	.223	-	8.091	.000	-	-
1)Gender	-.006	.047	-.005	-.124	.902	.027	-.007
2)Age	.046	.017	.126	2.654	.008	.347	.145
3)Income	-.005	.050	-.004	-.097	.923	.053	-.005
4)Education	-.004	.027	-.007	-.147	.883	-.107	-.008
5)Residential area	.023	.027	.037	.847	.398	.109	.047
6) Subjective religiosity	.106	.029	.179	3.611	.000	.460	.196
7)Frequency of worship	.187	.030	.371	6.291	.000	.600	.328
8)Frequency of prayer	.099	.038	.144	2.614	.009	.494	.143
R=.651	R <sup>2</sup> =.424	F=30.159	P=.000				

According to the regression analysis, when the predictor variables and the partial and binary correlations of the predicted variables were examined, it was found that there is a positive and moderately significant relationship between positive religious coping and the age variable ( $r=.347$ ;  $p<.01$ ), and when other predictive variables were controlled, the result of this relationship was  $r=.145$ . Also, it was determined that there was a moderately significant positive relationship ( $r=.460$ ;  $p<.01$ ) between subjective perception of religiosity and positive religious coping, and when other predictive variables were controlled, this relationship was found to be  $r=.196$ . It was also found that there was a positive and moderate relationship between frequency of worship and positive religious coping ( $r=.600$ ;  $p<0.1$ ), and when other predictive variables were controlled, this relationship was  $r=.328$ . Similarly, it was also determined that there was a positive and moderate relationship between the frequency of praying and positive religious coping ( $r=.494$ ;  $p<.01$ ), and when other predictive variables were controlled, this relationship was  $r=.143$ . Finally, positive religious coping showed a moderately positive relationship with all of its independent variables ( $R=.651$ ,  $R^2=.424$ ,  $P=.000$ ). A total of 8 variables predicting participants' positive religious coping scores explained 42% (.424) of the total variance. Considering the standardized regression coefficients, the relative order of importance of the predictor variables on

positive religious coping were as follows; 7, 6, 2, 8, 5, 4, 1, and 3. When T values were examined, only subjective religiosity perception, frequency of worship and prayer, and age significantly predicted positive religious coping, and the others had no significant effects on positive religious coping. Based on these findings, only the part of the **H(1)** associated with the “age” variable was confirmed in **H(1)** “*The socio-demographic variables such as gender, age, education, income, occupation, marital status, place of residence are predictors of positive religious coping*” and it can be argued that **H(2)** stating “*The subjective perception of religiosity, prayer and worship of the participants predict positive religious coping*” was fully confirmed. The findings on predictors of negative religious coping are shown in Table 2.

**Table 2.** *The Predictors of Negative Religious Coping (Enter Multiple Regression Analysis)*

Variables	$\beta$	Stand. Er.	$\beta$	t	p	Paired r	Partial r
Constant (Negat. Rel. Cop.)	2.716	.401	-	6.767	.000	-	-
1)Gender	-.039	.085	-.026	-4.61	.645	-.002	-.025
2)Age	.044	.031	.088	1.418	.157	.059	.078
3)Income	-.103	.091	-.065	-1.140	.255	-.048	-.063
4)Education	.066	.048	.084	1.374	.170	.041	.076
5)Residential area	-.006	.048	-.007	-1.115	.909	.004	-.006
6)Subjective religiosity	-.016	.053	-.019	-2.96	.768	-.010	-.016
7)Frequency of worship	-.005	.053	-.007	-.094	.926	.005	-.005
8)Frequency of prayer	.012	.068	.013	.178	.859	.016	.010

R=.110

R<sup>2</sup>=.012

F=.503

P=.854

As seen in Table 2, as a result of the study, it was determined that socio-demographic variables such as gender, age, income, education level, and place of residence did not have a significant effect on negative religious coping. In this respect, it was found that H(3) was not confirmed by the study findings as “*The socio-demographic variables such as gender, age, education, income, occupation, marital status, place of residence are predictors of negative religious coping*”. Similarly, subjective religiosity perception, worship, and prayer frequency variables did not have a significant effect on negative religious coping. Therefore, it can be argued that **H(4)**, which said, “*The subjective religiosity perception, prayer and worshiping status of the participants are predictors of negative religious coping*” was also not confirmed.

## DISCUSSION AND CONCLUSION

As a result of the regression analysis that was made to determine the effect of socio-demographic factors in the Personal Information Form on



positive religious coping, it was found that only the age variable, subjective religiosity perception, frequency of worship, and prayer predicted positive religious coping significantly ( $r=.347$ );  $r=.460$ ;  $r=.600$ ;  $r=.494$ ;  $p<.01$ ). It was also found that other variables did not have significant effects on positive religious coping. However, as a result of the regression analysis, it was also found that all independent variables (gender, age, income, education level, place of residence, subjective perception of religiosity, frequency of worship and prayer) did not have any significant effect on negative religious coping ( $p>.05$ ). As in religiosity, many factors can be effective on religious coping. In other words, the coping attitudes of individuals can change depending on a wide variety of factors such as age, gender, culture, and illness, and they have an individual-specific quality (Holahan & Moos, 1987). In this sense, it is suggested that the gender variable is an effective factor in religious coping. However, it was found that different kinds of findings were reached in previous studies on this subject. In some of these, no statistically significant differences were detected in terms of people's use of positive and negative religious coping methods according to gender status, as in the present study findings (Çevik Demir, 2013:194; Şentepe, 2015:186-205; Özdemir, 2016:38,40; Gül, Gül, Erberk Özen & Battal, 2017:250; Salim, 2017; Gümüş, 2017; Kulu, 2019:58; Özkan, 2019:64; Ferah, 2019:157;) In some previous studies, it was found that women used positive religious coping methods significantly more than men, confirming the thesis that women are more religious than men, and no significant differences were detected between both genders in terms of resorting to negative religious coping methods (Topuz, 2003:107; Sağır, 2014:48; Uysal, Göktepe Kaya, Karagöz & İlerisoy, 2017:149-150; Özcan, 2019:138; Bektaş, 2019:99; Çolak, 2020:139; Doğan & Karaca, 2021:340). In a smaller number of studies, men were found to have negative attitudes (Ekşi, 2001; Gencer & Cengil, 2020:339; Akkaya Türköl, 2020:42; Sağır, 2020:25; Angın, 2021:337) or positive religious coping methods significantly more than women (Ayten, 2012; Altıntaş, 2014; Bayraktutar, 2019:113). It was also found that women's use of both positive and negative religious coping styles was significantly higher than men in far fewer studies (Lewis, Maltby & Day, 2005; Ayten & Yıldız, 2016). In brief, although different types of results were obtained regarding individuals' use of positive and negative religious coping styles according to the gender variable, it can be argued that the findings of the present study are in line with the results of the meta-analysis examining the relationship between gender and religiosity (Yapıcı, 2012). For this reason, it can be argued that the view that gender is not a determining factor in the level of individuals' use of positive and negative religious coping styles finds support.

When the relationships between the age variable and religious

coping were examined, it was found that there are findings in the relevant literature supporting the study result, in other words, age level positively and significantly affects positive religious coping (Topuz, 2003:108; Ayten, 2012:98; Acar, 2014:147; Özdemir, 2016; Batan, 2016; Özgül, 2017:76; Özcan, 2019:139; Özkan, 2019:69; Çolak, 2020; Sağır, 2020:22-23; Akkaya Türkol, 2020; Kızılgeçit & Çinici, 2020:56; Angın, 2021:337). Such a result may be associated with the fact that people tend to religion more and their level of religiosity increases depending on the increase in age. It was also found that there is a positive correlation between age and religiosity in many studies both at home and abroad. The level of religiosity gradually increases in the first adulthood after adolescence and especially in middle-aged individuals, which is defined by Jung as the age of inclination towards spirituality (Koenig, 1995; Yapıcı, 2007). Based on this, it is a known fact that people with high religiosity levels resort to positive religious coping styles and activities, which was also revealed by previous studies. In this sense, since the religious coping process includes some religious elements, it can be expected that especially the positive religious coping levels will increase with age in parallel with the increased level of religiosity. In other words, in the process of coping with the difficulties that individuals face as they become older, positive religious copings such as “asking for help from Allah, strengthening the relationship with Allah through worship, prayers, asking for love and mercy from Allah, increasing trust in Allah”. It can be argued that such individuals use dating activities more frequently (Ayten & Sağır, 2014:14). However, it is also possible to see results contrary to this finding in some studies (Çevik Demir, 2013:153; Bayraktutar, 2016:116; Kulu, 2019; Ferah, 2019:160; Sağlam Demirkan, 2020). Considering the relationship between negative religious coping and age, it was found that results are supporting our study findings in the relevant literature (Ayten & Sağır, 2014:14; Özdemir, 2016:38; Uysal et al., 2017:150; Murat, 2018:146; Bektaş, 2019:103; Özkan, 2019:69; Sağır, 2020:22-23; Kızılgeçit & Çinici, 2020:56; Doğan & Karaca, 2021:340; Akkaya Türkol, 2020:43; Çolak, 2020:144-145).

Education level is also among the factors that affect religious coping. In most previous studies, it was found that the religious beliefs of individuals weaken as the education level increases. In this sense, although findings are showing that religious beliefs are weak, especially because of the more rational and critical thinking in individuals educated at the university level, there are also study results showing the contrary status (Batson, Schoenrade & Ventis, 1993). For this reason, when the relevant literature was reviewed, contrary to our findings, there were mostly negative and significant relationships between positive religious coping and education levels (Ekşi, 2001:112, 123; Ayten, 2012:97; Çevik Demir, 2013:197; Sağır,

2014:59; Özdemir, 2016:38,40; Uysal et al., 2017:150; Murat, 2018:147; Kulu, 2019:73; Ferah, 2019:161; Akkaya Türkol, 2020:45). However, the findings of the study conducted by Doğan & Karaca (2021:340) on healthcare employees fully support our findings. Also, as a result of some studies, it was found that education levels did not have significant impacts on negative religious coping, as in our study findings (Çevik Demir, 2013:197, 199; Özdemir, 2016:38, 40; Ferah, 2019:161; Akkaya Türkol, 2020:45).

It can be argued that income status is also an effective factor in religious coping. In the studies conducted in the West and Turkey, it was generally found that religion is a value for people with low-income levels, and there is a decreased adherence to religious beliefs and performing religious worship in parallel with increased income levels ( Kurt, 2009: 37-59; Hökelekli, 2015:97). In some studies conducted in this field, it was found that those who had low and middle incomes applied more positive or negative religious coping methods than those in the higher income group (Ekşi, 2001:134; Çevik Demir, 2013:156; Şentepe, 2015:186-205; Ferah, 2019:163; Bayraktutar, 2019:123-124). It was reported in some studies that income level did not have significant impacts on positive and negative religious coping, supporting our study findings (Karakaş & Koç, 2014:610-631; Özdemir, 2016:40; Murat & Kızılgöç, 2017: 111-151; Bektaş, 2019:105-106). It was found in some studies that as the income levels rise, positive (Bayraktutar, 2019:123-124) or negative religious coping (Topuz, 2003:67) is used more.

The social sphere in which one lives and the cultural structure of the society can be effective in how individuals can choose a religious coping method when faced with distressing and stressful situations. For this reason, it is seen that people who live in different cultures and geographical areas despite belonging to the same religion prefer different religious coping methods against similar problems (Pargament, 1997: 191-192). In this regard, some previous studies showed that people who lived in rural areas such as villages and towns applied to positive religious coping activities significantly more than those living in urban centers such as cities and big cities (Ferah, 2019:164; Çolak, 2020:161). for this reason, it was found that the place of residence or country had significant effects on positive religious coping styles (Kızılgöç & Çinici, 2020:56; Özcan, 2019:138-139). However, in most previous studies, it was also found that the place of residence, where most of the life passes, does not make a significant difference in applying negative religious coping methods, which somewhat supports our study finding (Ferah, 2019:164; Kulu, 2019:78; Çolak, 2020:161; Kızılgöç & Çinici, 2020: 56). However, in another study conducted by Bayraktutar (2019:122) on Imam Hatip High School

students, the social setting (urban or rural environment), it was found that there were no significant differences in both positive religious coping and negative religious coping dimensions ( $p > .005$ ).

Every stressful life event that a person faces disrupts the mental balance. The person, whose mental balance is shaken and deteriorated, resorts to several coping activities to restore the balance. It is expected that a person who has religious beliefs and values and tries to live his life in this direction will naturally resort to coping activities involving religious elements to rebuild the disturbed inner peace. In many previous empirical studies, it was reported that individuals who had stronger religious beliefs and sincere adherence to religion tended to engage in more religious coping activities and used these more frequently. For this reason, the more religious people perceive themselves to be, the more often they can resort to religious coping and especially positive religious coping (Turan, 2018:418). In this context, when the relevant literature was reviewed, it was seen in most of the studies conducted that subjective religiosity perception was positively associated with positive religious coping and negatively associated with negative religious coping, which is partially similar to our study findings. In other words, as the perceptions of subjective religiosity of individuals increase, their frequency of using positive religious coping methods also increases, and when subjective religiosity perception decreases, their level of resorting to negative religious coping styles increases (Turan, 2018:417; Bektaş, 2019:107-108; Bayraktutar, 2019:142; Kulu, 2019:82; Doğan & Karaca, 2021:344). In their study, as in our study, Ayten and Yıldız (2016:297) and Ferah (2019:174) reported a positive and significant relationship between subjective religiosity and positive religious coping, and the relationship between subjective religiosity perception and negative religious coping was not statistically significant. In Sağır's (2014) study, it was reported that a positive and significant relationship was detected between the frequency of participants' use of positive and negative religious coping activities and their subjective religiosity perceptions.

Religion, which provides people with the courage to face and overcome the troubles and difficulties that come their way on the stage of life, also helps transform life by responding to the search for meaning in the coping process with a sense of confidence and control, comforting and healing, offering intimacy and support, and contributing to personal growth with central importance in coping activities (Pargament, 1997:234-235; Pargament, Kenneth, et. al., 2000:521; Pargament, 2005:288-290). In coping with negative situations, religious beliefs and practices help people to feed the sense of hope, provide them with a sense of purpose and transcendence, reduce negative emotions such as fear and anxiety, and have a belief in a loving, protective, all-knowing, omnipotent God and

the Hereafter. It is stated that it can be psychologically relaxing (Dein, Loewenthal, Lewis & Pargament, 2020:3; Rajkumar, 2020:6). Right at this point, it was reported in previous studies conducted abroad and at home that people generally turn to religious activities such as “prayer, worship, and dhikr” to cope with the pandemic process, and for this reason, they frequently used religious coping to cope with the pandemic and the negativities it brought. For example, in a previous study that was conducted in Iran, it was found that Iranian families prayed together and spent more time reading the Qur’an (Fardin, 2020:2). According to Pargament (1997:301), prayer is among the most frequently used religious coping methods. In some studies conducted on religious coping, it was reported that the Qur’an, which supports that prayer is the most frequently used religious coping activity, drew attention to the fact that people who felt helpless when faced with negative life events tended to pray more psychologically (Yunus, 10/12; 22-23; Fussilet 41/51; Al-Rum 30/33; Al-Zumar 29/8). It was reported in the Hadiths that prayer is a shield against accident and prevents many sorrows and disasters that were experienced and will be experienced (Tirmidhi, “Daavat”, 145; Tirmidhi, “Salat”, 13) and it should be noted that prayer is an effective method in dealing with negative life events and believers are advised to pray when faced with troubles and difficulties. Prayer is considered the beginning of religious coping for a person who faces stress and negative life events and expresses the person’s request for help from the divine power (Arıcı, 2005:84). For this reason, prayer is an effective coping strategy with the function of creating a sense of control for people who face negativities in life (Rusu & Turliuc, 2017:488). Prayer, which is a way of connecting directly with the believed superior and supreme being, is the communication of the weak, helpless and ephemeral person with the almighty and eternal Supreme Being and asking for help from Him (Kayıklık, 2011:129). Prayer is also the state of knowing that God is the only cure for troubles, rather than telling God about troubles by praying (Albayrak, 2007: 189-201). Therefore, it can be argued that prayer is a way of salvation, and a glimmer of hope, in a way, is also a source of hope for the individual, making a great contribution to overcoming the feelings of hopelessness, pessimism, and loneliness, and gives the joy of living by keeping the individual alive (Kımtır, 2002:183-208). In this sense, the person who prays is aware that s/he is not alone when faced with the negative life event experienced, and that the being who sees and knows his/her pain, distress, and grief and hears his/her call for help will definitely show a way out and extend a helping hand. For this reason, prayer plays major roles in emotion-focused coping and also plays an active role in problem-focused coping because of the clarity it provides in the mind about the solution to the problem (Esen Ateş, 2019:43). In this respect, the disturbed soul balance of the person is re-established with

prayer, and feelings such as loneliness, helplessness, and insolubility are replaced by strength and fortitude (Karaca, 2011:147).

When people who face a stressful and worrisome situation or event feel powerless and helpless, they feel the need to take shelter in a superior and powerful being and turn to religious worship and rituals besides prayer presenting their troubles to the Almighty Allah, with whom they communicate through prayers and worship, and ask Him for help. In such troubled and stressful conditions, appealing of people to Allah and presenting their troubles to Him is not an escape or abandonment behavior, but a religious attitude that one takes to cope with negative emotions such as fear, sadness, hopelessness, and insecurity (Hökelekli, 1993: 114-115). Previous studies showed that people tend to pray and worship more in stressful situations (Pargament & Brant, 1998: 124). For this reason, the tendency to pray and worship emerges in many people when they face distressing and stressful life events such as wars, earthquakes, diseases, accidents, and deaths (Kula, 2005: 59). In this sense, studies conducted abroad and in the country show that people all over the world turn to religious beliefs and worship, especially prayer, to cope with the negativities caused by the Covid-19 pandemic. In other words, some people turned to more religious worship (praying, prayers, reading scriptures, etc.) to be closer to God, while others behaved in ways that would gain God's consent and pleasure (being generous, sharing, being humble, etc.) in this process (Kalgı, (2021: 134) because practices such as prayer, worship, and ritual give the believer a sense of being with God, creating a sense of insight and peace (Horozcu, 2012:182). Previous studies also revealed that people who pray and worship frequently and regularly are psychologically protected against stress and anxiety (Koç, 2000:160). Therefore, praying and worshipping, which are the indicators of religiosity in the real world, affect religious coping (Hayta, 2000: 128). Empirical studies also support this finding issue. In this context, similarly, in a study conducted on prayer and religious coping, it was found that there were significant relationships between concentration in prayer and frequency of prayer and positive coping (Arıç, 2005: 158). Similar findings were reported in studies that investigated the relationship between worship and religious coping. In other words, in parallel with our study findings, in other studies, it was reported that the state of performing religious prayers positively affects positive religious coping, and there is a positive and significant relationship between fulfilling religious prayers and positive religious coping (Şentepe, 2015:199; Ferah, 2019:175; Bayraktar, 2019:106; Altun, 2021: 565-568). However, in some studies, as in our study result, although no statistically significant relationship was reported between the state of performing prayers and the use of negative religious coping methods (Şentepe,



2015:199; Ferah, 2019:175), it was determined in some studies that there is a negative and significant relationship between the state of worship and negative religious coping (Bayraktutar, 2019:106; Altun, 2021: 568).

To summarize, as a result of the study, it was found that although age variable, subjective religiosity perception, and frequency of performing prayers and prayers were statistically effective on positive religious coping styles of individuals, other variables did not have significant effects on positive religious coping. Also, socio-demographic and cultural characteristics such as gender, age, income, education level, place of residence, as well as subjective religiosity perception, and frequency of prayer and worship did not have statistically significant effects on negative religious coping styles. Depending on the place where the study is conducted, the time, the sample group, and the different measurement tools used, the effects of factors affecting the religious coping styles of individuals may vary. To uncover the effects of these factors on religious coping styles more clearly, it may be useful to conduct other studies using different measurement tools on different sample groups. Considering the subjective perception of religiosity, prayer, and worship, which are the predictors of positive religious coping, might be beneficial in terms of treatment in religiously structured therapies. Since the data obtained from the study were limited to the sample group from which the data were collected, the time of the study, and the measurement tools used, the generalization of the study findings may be scientifically misleading.

## REFERENCES

- Acar, H. (2014). *Kur'an Kurslarına Devam Eden Kadınlar Arasında Dindarlık Biçimleri, Dini Başa Çıkma Faaliyetleri ve Psikolojik İyilik Halleri*. Yayınlanmamış doktora tezi, Dokuz Eylül Üniversitesi, İzmir.
- Ağargün, M. Y., Beşiroğlu, L., Kıran, Ü. K., Özer, Ö. A. & Kara, H. (2005). COPE (Başa çıkma tutumlarını değerlendirme ölçeği): Psikometrik özelliklere ilişkin bir ön çalışma. *Anadolu Psikiyatri Dergisi*, 6(4), 221-226.
- Akkaya Türkol, Y. (2020), *Kişilik Özellikleri ve Dini Başa Çıkma Arasındaki İlişkinin İncelenmesi (Çorum Örneği)*. Yayınlanmamış yüksek lisans tezi, Hitit Üniversitesi, Çorum.
- Albayrak, A. (2007). Dindarlık Tipleri Açısından Dua Formları. *Marife Dergisi*, 7(2), 189-201.
- Altıntaş, S. (2014). *Depresyon ile Dinsel Başa Çıkma Arasında İlişki Üzerine Bir Çalışma*. Yayınlanmamış doktora tezi, Dokuz Eylül Üniversitesi, İzmir.
- Altun, V. K. (2021). Din Eğitimi Açısından Dindarlık ve Olumlu Dini Başa Çıkma Arasındaki İlişkinin İncelenmesi. *Kilis 7 Aralık Üniversitesi İlahiyat Fakültesi Dergisi*, 8 (2), 549-571.
- Angın, Y. (2021). Covid-19 Pandemi Sürecinden Geçerken Sağlık Çalışanlarında Dinî Başa Çıkma ve Psikolojik Sağlık İlişkisi Üzerine Bir Araştırma. *Cumhuriyet İlahiyat Dergisi*, 25(1), 331- 345.
- Arıcı, A. (2005). *Ergenlerde Dini Başa Çıkma Yöntemi Olarak Dua*. Yayınlanmamış yüksek lisans tezi, Uludağ Üniversitesi, Bursa.
- Aslan, R. (2020). Kovid-19 fizyoloji ve psikolojiyi nasıl etkiliyor? *Ayrıntı Dergisi*, 8(88), 47-53.
- Ayten, A. (2012). *Tanrıya Sığınmak: Dinî Başa Çıkma Üzerine Psiko-Sosyal Bir Araştırma*. İstanbul: İz Yayıncılık.
- Atkinson, R.L., Atkinson, R. C., Smith, E. E., Bem, D. J. & Hoeksema, S. N. (2010). *Psikolojiye Giriş* (6.Bsk.). Yavuz Alogan (Çev.). Ankara: Arkadaş Yayınları.
- Ayten, A.& Yıldız, R. (2016). Dindarlık, Hayat Memnuniyeti İlişkisinde Dini Başa Çıkmanın Rolü Nedir? Emekliler Üzerine Bir Araştırma. *Dinbilimleri Akademik Araştırma Dergisi*, 16(1), 281-308.
- Ayten, A. & Sağır, Z. (2014). Dindarlık, Dinî Başa Çıkma ve Depresyon İlişkisi: Suriyeli Sığınmacılar Üzerine Bir Araştırma. *Marmara Üniversitesi İlahiyat Fakültesi Dergisi*, 47, 5-18. DOI 10.15370/muifd.86222.
- Bahadır, A. (2002). *İnsanın Anlam Arayışı ve Din*. İstanbul: İnsan Yayınları.
- Baltaş, Z. & Baltas, A. (2012). *Stres ve Başa Çıkma Yolları*. İstanbul: Remzi Kitapevi.



- Batan, N. (2016). *Yetişkinlerde Psikolojik Dayanıklılık ve Dini Başa Çıkmanın Yaşam Doyumuna Etkileri*. Yayınlanmamış doktora tezi, Marmara Üniversitesi, İstanbul.
- Batson, C. D., Schoenrade, P. A. & Ventis, W. L. (1993). *Religion and The Individual. A Social Psychological Perspective*. New York: Oxford University Press.
- Bayraktutar, M. (2019), *İmam Hatip Lisesi Öğrencileri Örnekleminde Dinî Başa Çıkma ve Tanrı Tasavvuru İlişkisi*. Yayınlanmamış yüksek lisans tezi, Marmara Üniversitesi, İstanbul.
- Bektaş, S. (2019). *Ergenlerde Benlik Saygısı ve Dinî Başa Çıkma (İmam Hatip Lisesi Öğrencileri Örneği)*. Yayınlanmamış yüksek lisans tezi, Marmara Üniversitesi, İstanbul.
- Burger, J. M. (2006). *Kişilik*. İnan Deniz Erguvan Sarıoğlu (Çev.). İstanbul: Kaknüs Yayınları.
- Cohen, A. B., & Koenig, H. G. (2003). Religion, religiosity and spirituality in the biopsychosocial model of health and ageing. *Ageing international*, 28(3), 215-241.
- Cüceloğlu, D. (2001). *İyi Düşün Doğru Karar Ver (37.Bsk.)*. İstanbul: Remzi Kitabevi.
- Çevik Demir, Ş. (2013). *Ergenlerde Benlik Saygısı ve Dinî Başa Çıkma*. Yayınlanmamış doktora tezi, Uludağ Üniversitesi, Bursa.
- Çolak, M. B. (2020), *İşsizlik, Stres ve Dini Başa Çıkma*, Yayınlanmamış yüksek lisans tezi, Hitit Üniversitesi, Çorum.
- Dein, S., Loewenthal, K., Lewis, C. A. & Pargament, K. I. (2020). COVID-19, mental health and religion: An agenda for future research. *Mental Health, Religion & Culture*, 23(1), 1-9.
- Delonghis, A. & Newth, S. (2001). *Coping with Stress, Assesment And Therapy*. Howard S.Friedman (Ed.). California: Academic Press.
- Doğan, M. ve Karaca, F. (2021). Covid-19 Salgın Sürecinde Aktif Çalışan Sağlık Çalışanlarında Ölüm Kaygısı ile Dini Başa Çıkma Arasındaki İlişki Üzerine Bir Araştırma. *İlahiyat Tetkikleri Dergisi*, 55, 327-351.
- Ekşi, H. (2001). *Baş a Çıkma, Dini Baş a Çıkma ve Ruh Sağ lığı İlişkisi Üzerine Bir Araştırma*. Yayınlanmamış doktora tezi, Uludağ Üniversitesi, Bursa.
- Haque, A. (2012). Psikoloji ve Dinin Etkileşimi: Trendler ve Gelişmeler. *A.Ü. İlahiyat Fakültesi Dergisi*, N. Erdoğan Korkmaz (Çev.). 53(1), 149-166.
- Esen Ateş, N. (2019). Dua ve Dinî Baş a Çıkma: Şehit Aileleri, Gaziler ve Gazi Aileleri Örneği. *KSÜ İlahiyat Fakültesi Dergisi*, 33, 35-64. <https://doi.org/10.35209/ksuifd.558288>.

- Fardin, M. A. (2020). Covid-19 Epidemic and Spirituality, A Review of the Benefits of Religion in Times of Crisis. *Journal of Chronic Disease Care* 9(2), 1-5. <https://doi.org/10.5812/jjcd.104260>.
- Ferah, N. (2019), *Boşanma Sürecindeki Bireylerde Din Başa Çıkma Davranışının Analizi*. Yayınlanmamış doktora tezi, Sakarya Üniversitesi, Sakarya.
- Folkman, S. & Moskowitz, J. T. (2004). Coping: Pitfalls and promise. *Annual Review of Psychology*, 55, 745-774.
- Folkman, S., Lazarus, R. S., Gruen, R. J. & DeLongis, A. (1986). Appraisal, coping, health status, and psychological symptoms. *Journal of personality and social psychology*, 50(3), 571-579.
- Galea, S., Merchant, R. M. & Lurie, N. (2020). The mental health consequences of COVID-19 and physical distancing: the need for prevention and early intervention. *JAMA internal medicine*, 180(6), 817-818.
- Gencer, N. & Cengil, M. (2020). Travma Sonrası Büyüme ve Din, *Dindarlık*. Nevzat Gencer & Muammer Cengil (Eds), *Kişilik ve Ruh Sağlığı* içinde (s.323-358). İstanbul: Çamlıca Yayınları.
- Gül, A., Gül, H., Erberk Özen, N. & Battal, S. (2017). Major Depresyon Hastalarında Çocukluk Çağı Travmaları ve Başa Çıkma Tutumlarının Cinsiyete Özgü Farklılıkları. *Türk Psikiyatri Dergisi*, 28(4), 246-254.
- Güler Aydın, Ö. (2010). Dini İnanç ve Psikolojik Sağlık İlişisine Dair Bir Değerlendirme, *Toplum Bilimleri Dergisi*, 4(8), 95-105.
- Gümüş, R. (2017). *Evde Bakım Ücretinden Yararlanan Bakıcılarda Dinî Başa Çıkma: Bucak Örneği*. Yayınlanmamış yüksek lisans tezi, Süleyman Demirel Üniversitesi, Isparta.
- Hayta, A. (2000). U.Ü İlahiyat Fakültesi Öğrencilerinin İbadet Ve Ruh Sağlığı (psiko-Sosyal Uyum) İlişkisi Üzerine Bir İnceleme. *Uludağ Üniversitesi İlahiyat Fakültesi Dergisi* 9(9), 487-506.
- Holahan. C. & Moos RH. (1987). Personal and contextual determinants of coping strategies. *J Pers Soc Psychol*, 52, 946-955.
- Horozcu, Ü. (2012). Ruh Sağlığı ve Din. M. Doğan Karacoşkun (Ed.), *Din Psikolojisi El Kitabı* içinde (s. 177-190). Ankara: Grafiker Yayınları.
- Hökelekli, H. (2015). *Din Psikolojisine Giriş*, İstanbul:Dem Yayınları
- Hökelekli, H. (1993). *Din Psikolojisi*. Ankara: TDV Yayınları.
- Kalgı, M. E. (2021). Covid-19 Salgınına Yakalanan Kişilerde Dindarlık ve Dinî Başa Çıkma. *Marife*, 21 (1), 131-150. <https://doi.org/10.33420/marife.908432>.
- Kalgı, M. E. (2021). Koronavirüs Salgını ve Dindarlıkla İlgili Yapılmış Ampirik Çalışmaların Analizleri. *DEUİFD*, 53, 111-132.
- Karaca, F. (2011). *Din Psikolojisi*. Trabzon: Eser Ofset Matbaacılık.

- Karakaş, A. C. & Koç, M. (2014). Stresle Başa Çıkma ve Dini Başa Çıkma Yöntemleri Arasındaki İlişkinin Çeşitli Değişkenler Açısından İncelenmesi. *İnsan ve Toplum Bilimleri Araştırmaları Dergisi*, 3(3), 610-631.
- Karataş, M. (2018). *Görme Engelli Çocukların Ebeveynlerinde Dini Başa Çıkma*. Yayınlanmamış yüksek lisans tezi, Marmara Üniversitesi, İstanbul.
- Kayıklık, H. (2011). *Din Psikolojisi: Bireysel Dindarlık Üzerine*. Adana: Karahan Kitabevi.
- Kirkpatrick, L. A. (1998). God as a substitute attachment figure: A longitudinal study of adult attachment style and religious change in college students. *Personality and social psychology bulletin*, 24(9), 961-973.
- Kızılgöç, M. ve Çinici, M. (2020). Koronavirüs (Covid-19) Sürecinde Yapay Sinir Ağları Yöntemiyle Bireylerin Dini Başa Çıkma Düzeylerinin Tahmini. *İlahiyat Tetkikleri Dergisi*, 45-65.
- Kımtır, N. (2002). Dinî İnanç, İbadet ve Duanın Umutsuzlukla İlişkisi Üzerine. Hayati Hökelekli (Ed.), *Gençlik, Din ve Değerler Psikolojisi* içinde (s.183-208). Ankara: Ankara Okulu Yayınları.
- Koç, M. (2000). Dinsel Pratiklerin Sıklık Düzeyleri İle Dinî Başa Çıkma Arasındaki İlişki: Ergenler Üzerine Ampirik Bir Araştırma. *Bilimname*, 16(1), 140-182.
- Koenig, H. G. (1995). Religion and Older Man in Prison. *International Journal of Geriatric Psychiatry*, 10, 219-230.
- Koenig, H.G, Pargament, K.I., Neilsen, J. (1998). Religious Coping and Health Status Medically Ill Hospitalized Older Adults. *Journal of Nervous and Mental Disease*, 186(9), 513-521.
- Kulu, F. (2019), *Ergenlik Döneminde Dinî Başa Çıkma Ve Anlam Arayışı*. Yayınlanmamış yüksek lisans tezi, Marmara Üniversitesi, İstanbul.
- Kula, N. (2005). *Bedensel Engellilik ve Dini Başa Çıkma*. İstanbul: Dem Yayınları.
- Kula, N. (2002). Deprem ve Dinî Başa Çıkma. *Gazi Üniversitesi Çorum İlahiyat Fakültesi Dergisi*, 1(1), 234-255.
- Kurt, A. (2009). Bireyselden Toplumsala Geçişte Din. *Uludağ Üniversitesi İlahiyat Fakültesi Dergisi*, 18 (1), 37-59.
- Lazarus, R.S. (1993). Coping Theory and Research: Past, Present, and Future. *Psychosomatic Medicine* 55, 234-247.
- Lazarus, R. S. & Folkman, S. (1984). *Stress, Appraisal and Coping*. New York: Springer Publishing.
- Lewis, C., Maltby, J. & Day, L. (2005). Religious Orientation, Religious Coping and Happiness Among UK Adults. *Personality ve Individual Differences*, 38, 1193-1202.

- McIntosh, D. N. (1995). Religion-as-schema, with implications for the relation between religion and coping. *The International Journal for the Psychology of Religion*, 5(1), 1-16.
- Meza, D. (2020). In a pandemic are we more religious? Traditional practices of catholics and the COVID-19 in Southwestern Colombia. *International Journal of Latin American Religions*, 4(2), 218-234.
- Murat, A. (2018). *Yas ve Dinî Başa Çıkma: Bir Klinik Örneklem Değerlendirmesi*. Yayınlanmamış yüksek lisans tezi, Recep Tayyip Erdoğan Üniversitesi, Rize.
- Murat, A. ve Kızılgeçit, M. (2017). Dini Başa Çıkma ve Psikopatoloji İlişkisi (Rize Örneği). *Recep Tayyip Erdoğan Üniversitesi İlahiyat Fakültesi Dergisi*, 6(11), 111-151.
- Okan, N. ve Ören, A. (2021). Covid-19 Sürecinde Yaşanılan Olumsuz Duygularda Dini Başa Çıkma'nın Rolü, *İlahiyat Tetkikleri Dergisi*, 56, 359-380.
- Özcan, Z. (2019). Mülteci Öğrencilerin Kültürel Uyumları ile Dinî Başa Çıkmaları Arasındaki İlişki Üzerine Bir Araştırma. *Cumhuriyet İlahiyat Dergisi*, 23(1), 127-147.
- Özdemir, F. (2016), *Palyatif Bakım Alan Hastaların Yakınlarının Yaşadıkları Psikososyal Sorunlar İle Dinî Başa Çıkma Tarzları Arasındaki İlişkinin İncelenmesi*. Yayınlanmamış yüksek lisans tezi, Medipol Üniversitesi, İstanbul.
- Özgül, M. (2017). *Dinî Başa Çıkma ile Sürekli Öfke-Öfke İfade Tarzları İlişkisi Üzerine Bir Araştırma*. Yayınlanmamış yüksek lisans tezi, Kastamonu Üniversitesi, Kastamonu.
- Özkan, B. (2019). Yetişkinlerde Bağlanma Stilleri ve Dinî Başa Çıkma İlişkisi. Yayınlanmamış yüksek lisans tezi, Marmara Üniversitesi, İstanbul.
- Pargament, K. I. (2005). Acı ve Tatlı: Dindarlığın Bedelleri ve Faydaları Üzerine Bir Değerlendirme. Ali Ulvi Mehmedoğlu (Çev.). *ÇÜİFD*, 5(1), 279-313.
- Pargament, K. I. (1997). *The Psychology of Religion and Coping Theory, Research, Practice*. New York: The Guilford Press.
- Pargament, K. I. & Brant, C. (1998). Religion and coping. In: H Koenig (Ed.). *Handbook of Religion and Mental Health*. San Diego: Academic Press.
- Pargament, K. I., Smith, B. W., Koenig, H. G. & Perez, L. (1998). Patterns of positive and negative religious coping with major life stressors. *Study of Religion 37, Journal for the Scientific*, 37(4), 710-724.
- Pargament, K. I., Koenig, H. G. & Perez, L. M. (2000). The many methods of religious coping: Development and initial validation of the RCOPE. *Journal of clinical psychology*, 56(4), 519-543.
- Pargament, K. I. (2003). Din psikolojisi açısından başa çıkmanın teorik çatısına doğru. Ahmet Albayrak (Çev.). *Tabula Rasa Dergisi*, 3(9), 207-227.

- Pargament, K. I., & Rye, M. S. (1998). Forgiveness as a method of religious coping. *Dimensions of forgiveness: Psychological research and theological perspectives, 1*, 59-78.
- Pargament, K. I., Kennell, J., Hathaway, W., Grevengoed, N., Newman, J. & Jones, W. (1988). Religion and the problem-solving process: Three styles of coping. *Journal for the scientific study of religion, 27*(1), 90-104.
- Pargament, K. I., Koenig, H. G., Tarakeshwar, N. & Hahn, J. (2004). Religious coping methods as predictors of psychological, physical and spiritual outcomes among medically ill elderly patients: A two-year longitudinal study. *Journal of health psychology, 9*(6), 713-730.
- Pargament, K. I., Ensing, D. S., Falgout, K., Olsen, H., Reilly, B., Van Haitsma, K. & Warren, R. (1990). God help me:(I): Religious coping efforts as predictors of the outcomes to significant negative life events. *American journal of community psychology, 18*(6), 793-824.
- Pargament, K.I. & Park, C. L. (1997). *The Psychology of Religion, Theoretical Approaches*, Part 2.B. Spilka, and D. N. McIntosh (Eds.). USA: Westview Press.
- Pillay, A. L. & Barnes, B. R. (2020). Psychology and COVID-19: Impacts, themes and way forward. *South African Journal of Psychology, 50*(2), 148-153.
- Poyrazli, S. & Can, A. (2020). Çevrim içi Psikolojik Danışma: Etik Kuralları, COVID-19 Süreci, Öneriler. *Okul Psikolojik Danışmanlığı Dergisi, 3*(1), 59-83.
- Rajkumar, P. R. (2020). The Relationship Between Measures of Religiosity and the Prevalence and Outcome of Covid-19, a Population-level Pilot Study. <https://www.researchsquare.com/article/rs-33245/v1> (Erişim 20.10.2021).
- Roman, N. V., Mthembu, T. G. & Hoosen, M. (2020). Spiritual care—‘A deeper immunity’—A response to Covid-19 pandemic, *African Journal of primary health care and family medicine, 12*(1), 1-3.
- Roskies, E. (1998). *Savaş Ya da Kaç Tepkisi: Strese Gösterilen İlk Tepkiler*. N. H. Şahin (Çev.). Ankara: Türk Psikologları Derneği Yayınları.
- Rusu, P. P. & Turliuc, M. N. (2017). Psikolojik Araştırmalarda Dindarlığa Yaklaşım Tarzları. Fatma Kırman (Çev.). *Çukurova Üniversitesi İlahiyat Fakültesi Dergisi, 17* (1), 481-499.
- Sağır, Z. (2014). *Suriyeli Mültecilerde Dinî Başa Çıkma ve Ruh Sağlığı*. Yayınlanmamış yüksek lisans tezi, Marmara Üniversitesi, İstanbul.
- Sağır, Z. (2020). Kültürleşme, Dini Başa Çıkma ve Yaşam Memnuniyeti: Türkiye’de Yaşayan Yabancı Öğrenciler Üzerine Nicel Bir Araştırma, *Kilitbahir, 17*, 5-37.
- Sağlam Demirkan, F. (2020). *Diyaliz Hastalarında Bağlanma, Dini Başa Çıkma ve Yaşam Memnuniyeti Arasındaki İlişki Üzerine Bir Araştırma*. Yayınlanmamış Doktora Tezi, İstanbul Üniversitesi, İstanbul.

- Salim, E. (2017). *Boşanma Sürecindeki Bireylerde Başa Çıkma Stratejileri ve Dini Başa Çıkma: Isparta Örneği*. Yayınlanmamış yüksek lisans tezi, Süleyman Demirel Üniversitesi, Isparta.
- Saral, K. (2013). *Yetiştirme Yurdunda Kalan Ergenlerin Stresle Başa Çıkma Tarzları Eğitim Öğretim Yaşantılarında Stresle Başa Çıkma ve Sosyal Karşılaştırma Düzeylerinin Bazı Değişkenler Açısından İncelenmesi*. Yayınlanmamış yüksek lisans tezi, İstanbul Arel Üniversitesi, İstanbul.
- Sears, D.O., Peplau, L. A. & Taylor, S. E. (2015). *Sosyal Psikoloji* (5. baskı). A. Dönmez (Çev.). Ankara: İmge Kitabevi Yayınları.
- Şentepe, A. (2015). Yaşlılık Döneminde Dinî Başa Çıkma, *İnsan ve Toplum Bilimleri Araştırmaları Dergisi*, 4(1), 186-205.
- Tarakeshwar, N., Vanderwerker, L. C., Paulk, E., Pearce, M. J., Kasl, S. V. & Prigerson, H. G. (2006). Religious coping is associated with the quality of life of patients with advanced cancer. *Journal of palliative medicine*, 9(3), 646-657.
- Topuz, İ. (2003). *Dini Gelişim Seviyeleri ile Dini Başa Çıkma Tutumları Arasındaki İlişki Üzerine Bir Araştırma*. Yayınlanmamış doktora tezi, Uludağ Üniversitesi, Bursa.
- Turan, Y. (2018). Yalnızlıkla Başa Çıkma: Yalnızlık, Dinî Başa Çıkma, Dindarlık, Hayat Memnuniyeti ve Sosyal Medya Kullanımı. *Cumhuriyet İlahiyat Dergisi*, 22 (1), 395-434.
- Uysal, V., Göktepe Kaya, A., Karagöz, S., İlerisoy, M. (2017). Dinî Başa Çıkma ile Umut, Hayat Memnuniyeti ve Psikolojik Sağlık Arasındaki Etkileşim Üzerine Bir Araştırma, *Marmara Üniversitesi İlahiyat Fakültesi Dergisi*, 52, 139-160. DOI: 10.15370/maruifd.333535.
- Wang, C., Pan, R., Wan, X., Tan, Y., Xu, L., Ho, C. S., & Ho, R. C. (2020). Immediate psychological responses and associated factors during the initial stage of the 2019 coronavirus disease (COVID-19) epidemic among the general population in China. *International Journal of Environmental Research and Public Health*, 17(5), 1729. <https://doi.org/10.3390/ijerph17051729>.
- Yapıcı, A. (2012). Türk Toplumunda Cinsiyete Göre Dindarlık Farklılaşması: Bir Meta-analiz Denemesi. *Fırat Üniversitesi İlahiyat Fakültesi Dergisi*, 17(2), 1-34.
- Yapıcı, A. (2007). *Ruh Sağlığı ve Din Psiko-Sosyal Uyum ve Dindarlık*. Adana: Karahan Kitabevi.
- Yöndem, Z. D. (2002). Stresle başatma stratejileri ölçeği (SBSÖ): Eleştirel bir değerlendirme. *Türk Psikolojik Danışma ve Rehberlik Dergisi*, 2(18), 43-47.

“

## Chapter 26

**MONETARY POLICY UNCERTAINTY AND  
STOCK MARKETS IN GCC COUNTRIES:  
EVIDENCE FROM METHOD OF  
MOMENTS QUANTILE REGRESSION  
APPROACH**

*Murat GUVEN<sup>1</sup>*

*Merve ALTAYLAR<sup>2</sup>*

”

---

1 Asst. Prof. Dr., Sakarya University, Faculty of Science, Department of Statistics, e-posta: muratguven@sakarya.edu.tr, orcid id: 0000-0001-5604-4369

2 MS Student, Koç University, Graduate School of Sciences and Engineering, Data Science, e-posta: maltaylar21@ku.edu.tr, orcid id: <https://orcid.org/0000-0001-5413-5048>

## 1. Introduction

The influence of monetary policy uncertainty(MPU) on the economies has recently been a prevalent issue. Many events, such as the global financial crisis, political disputes, Brexit, and the COVID-19 pandemic crisis, have revealed the importance of MPU on several economic and financial fundamentals. Monetary policy(MP) undertakes the success of a bunch of targets that are expressed in terms of macroeconomic indicators such as inflation, real output, and employment. Moreover, MP decisions such as changes in discount rates have an indirect impact on these indicators. Financial markets such as the stock market rapidly incorporate new information. Thus, a more direct and quick effect of changes in the MP instruments may be revealed utilizing financial-based data (Ioannidis and Kontonikas, 2008). Existing cumulative knowledge obtained from many research has provided much to understanding the influence of the US MP on stock market returns. The consensus is that MP has predictive power on stock market returns(Cai, 2018). Most studies evaluate the association between MPU and stock market returns.(e.g, Wen et al., 2022; Paule-Vianez et al., 2020b; Paule-Vianez et al., 2020a). These studies generally evaluate the link between MPU and stock market returns over country or country groups without considering the control variables. Hence, this motivates us to extend the study to different country groups using the control variable.

The existing financial literature does not ensure satisfying evidence of the MPU's impact on stock markets, taking into account control variables for the Gulf region. We explore the relationship between MPU and the stock market returns controlling industrial production(IP) in GCC regions. The stock return(SR)s are, in general, regarded as being highly sensitive to economic positions and among the most closely followed asset prices in countries' economies. In this research, the impact of the MPU index and IP on stock markets of the GCC countries(Qatar, Saudi Arabia, Kuwait, Bahrein, UAE, and Oman ) by considering the SRs percentiles are explored. Thus, we identify the impact of MPU index and IP on various positions of SRs in GCC countries

The purpose of this study is to explore the relationship between IP, MPU, and SRs in GCC countries, utilizing method of moments panel quantile regression(MMQR) estimator and investigate the pairwise causal relationship between the mentioned variables, utilizing Dumitrescu–Hurlin (DH) panel non-homogenous causality test employing monthly data for period January 2007 -December 2021. We find MPU index has a significantly negative impact on SR at the higher quantile of the bearish market (Q0.25), in the normal market, and in the bullish market in GCC countries. We also find that IP has a significantly positive impact in bearish market and a negative impact at the higher quantile of bullish market.



Finally, we find a bidirectional causal relationship between SR and IP and unidirectional causal relationship running from IP to MPU index

Our study differs from other studies in three important ways. First, our study explores the effect of MPU on SRs in GCC countries. Second, our study considers the impact of IP while testing the impact of MPU on the SRs of these countries. Finally, we use MMQR to acquire the influence of MPU and IP on various positions(different quantiles) of SRs in GCC countries. Hence, this is the first study that investigates the relationship between IP, MPU, and SRs in GCC countries, utilizing MMQR estimator and evaluates the pairwise causal relationship between the mentioned variables, utilizing DH panel non-homogenous causality test employing monthly data for the period January 2007-December 2021 to the best of my knowledge.

The following section presents a literature review. Section 3 illustrates data and section 4 presents methodology. Section 5 reports the results. Section 6 shows the conclusions.

## 2. Literature Review

This section covers a summary review of previous studies investigating the relationship between MPU, IP, and stock market returns. Different recent studies have examined the association between the MPU and stock market returns for a diverse group of economies by spanning various periods (Jansen and Tsai, 2010;Cai, 2018; Tiryaki et al., 2019; Paule-Vianez et al., 2020a, Paule-Vianez et al., 2020b;Chiang, 2021; Wen et al., 2022).

Jansen and Tsai(2010) examine how to impact the asymmetries in the MP changes to stock market returns in bearish and bullish market conditions for the period 1994 -2005. The results demonstrate that changes in MP when the market is bearish have negative and higher influences on stock market returns.

Cai(2018) focuses on New Zealand and Australia to explore the causality between MPU and SR(S&P/ASX and S&P/NZX, respectively) in the period 1992M10–2017M07 (the period is different according to countries, New Zealand covers the 2002M10-2017M07 period). Finding that demonstrates the unidirectional causality running from Australia's SRs to MPU is detected just during the Dot-com bubble period. On the other hand, the finding illustrates a unidirectional negative causality running from MPU to New Zealand's SR in the few months of 2010.

Tiryaki et al. (2019) study the influence of real effective exchange rate, money supply, and industrial production on SR, focusing on the Turkish economy. The study that covers the 1994-2017 period and applies the NARDL model shows that the changes in industrial production, money

supply, and real effective exchange rate on stock market returns are asymmetric.

The recent study of Paula-Vianez et al. (2020b) examines the impact of MPU on the stock market, controlling the IP for the period January 1985 - March 2020. In the research that utilizes the regression model, findings show that MPU along with IP have negative influences on SRs, and especially the most subjective and difficult-to-arbitrate stocks is more sensitive to MPU.

Paule-Vianez et al. (2020a) evaluate the impact of MPU on the SRs of the NASDAQ100 and S&P500, applying the regression analysis technique. The data in this study covers the period January 1990-December 2014. The findings demonstrate the impact of MPU on SR in periods of expansion and the role of uncertainty while preventing the damaging influence of MPU.

Another study by Chiang (2021) examines the impact of MPU, taking into account equity market volatility and dividend yield on international SRs. This study's findings show that MPU has significant negative effects, considering the influence to one month lag on stock market return in North America. The findings of this paper also illustrate the transmission of the increase in MPU to international stock market returns.

Wen et al. (2022) explore the heterogeneous and asymmetric effect of MPU on SR in G7 and BRICS countries, using the quantile-on-quantile regression technique to reveal the gradual structure. The results of the paper demonstrate that MPU has a negative impact on SRs for most countries in case of high MPU and low returns. Furthermore, these results show the reduction in returns due to the increased uncertainty in case of of crash due. This paper also indicates that the stock market responses of BRICS are less volatile than stock market responses of G7 countries to MPU shocks.

Most of these papers examine the association between stock market returns and the MPU index using different econometric techniques over advanced economies. However, fewer Studies consider the essential control variables while evaluating this association over the alternative country groups . To fill this gap in the financial literature, we explore the relationship between MPU and the stock market returns controlling the IP in the Gulf region economies, implementing the MMQR method.

### **3. Data**

In our study, we use monthly observations of MPU, stock market returns and IP in GCC countries. We collect the data of MPU index developed by Baker et al.(2016) from [www.policyuncertainty.com](http://www.policyuncertainty.com). Baker et al.(2016)

develop this MPU index for USA, using newspaper articles that considers several criteria. We also collect stock index data from Refinitive Eikon and IP data from <https://fred.stlouisfed.org/>(see Table 1 for variables). We employ the first difference of the logarithmic GCC countries' stock market index to obtain the stock market return. We also employ the first difference of the logarithmic MPU and industrial production.

The sample period is January 2007 - December 2021 for our observations. We select this period since it includes the global financial crisis that outbreaks in the USA in 2008, the debt crisis in the Euro Zone, and the COVID-19 pandemic that impacted the whole world in 2020. Figure 1 plots the SRs by countries, and MPU index and IP for this period. The top of Figure 1 depicts the MPU index and IP. IP is not a very active series in general; just like the MPU index, it has been subject to decreases during the financial crisis and pandemic periods. Figure 1 clearly displays that SRs by countries move quite similar to each other (especially in the period of global financial crisis, Arab Spring, COVID-19 pandemic) for the same period. Among the GCC countries, the sharpest decline in SRs occurred in Qatar, Oman, and Saudi Arabia (-0.32; -0.31 and -0.30, respectively) due to the 2008 crisis. Considering their financial structures and political relations, these countries are more dependent on the USA than other GCC countries. In addition, SRs of countries other than Oman did not reach the values they had taken in the periods before 2008. It is possible to remark from the graphs (individual) that the negative impact of the Arab spring on the markets was felt for a long time.

**Table 1. Variables**

Variables	Source	Abbreviation	Period
Stock Return	Refinitive Eikon	SR	2007 February- 2021 December
Monetary Policy Uncertainty	<a href="https://www.policyuncertainty.com/">https://www.policyuncertainty.com/</a>	MPU	2007 February- 2021 December
Industrial Production	<a href="https://fred.stlouisfed.org/">https://fred.stlouisfed.org/</a>	IP	2007 February- 2021 December

We first provide detailed descriptive statistics about our variables in Table 2. SR in Table 2 has values from -0.3193185 to 0.2307257. The mean, median, and standard deviation of the SR is 0.004698, 0.0063084, and 0.0582233, respectively. Finally, The Jarque-Bera (JB) test statistics show that we reject the null of normal distribution for SR and both Figures show the outliers (negative or positive). Thus, quantile regression is appropriate for analyzing the SRs of GCC countries.

**Table 2.** Descriptive Statistics

Variables	Mean	Median	St. Dev.	Maximum	Minimum	Skewness	Kurtosis	JB
Stock Return	0.004696	0.0063084	0.0582233	0.2307257	-0.3193185	-1.023005	8.354266	1470.2***
MPU Index	0.0054727	-0.0350522	0.3592652	1.489216	-0.969063	0.6464691	4.44542	28.050***
IP	0.0001129	0.0009535	0.0144732	0.0608633	-0.1415183	-5.069993	54.50409	20551.4***

Note: \*\*\* shows 1% level of significance.

Table 3 illustrates the pairwise correlations between MPU, IP and SR. Results in Table 3 show that MPU and SR are significantly negatively correlated. This result also demonstrate a statistically significant positive correlation between IP and SR.

**Table 3.** Pairwise Correlations

Variables	Stock Return	MPU Index	IP
Stock Return	1		
MPU Index	-0.1179* (0.0001)	1	
IP	0.0608** (0.0465)	-0.0087 (0.7768)	1

Note: i.\* and \*\*show 10%, and 5% level of significance, respectively.

ii. Parentheses indicate probabilities for correlation coefficients.

On the other hand, a low pairwise correlation (statistically insignificant) between MPU index and IP indicates a lower chance of a multicollinearity problem in our regression model.

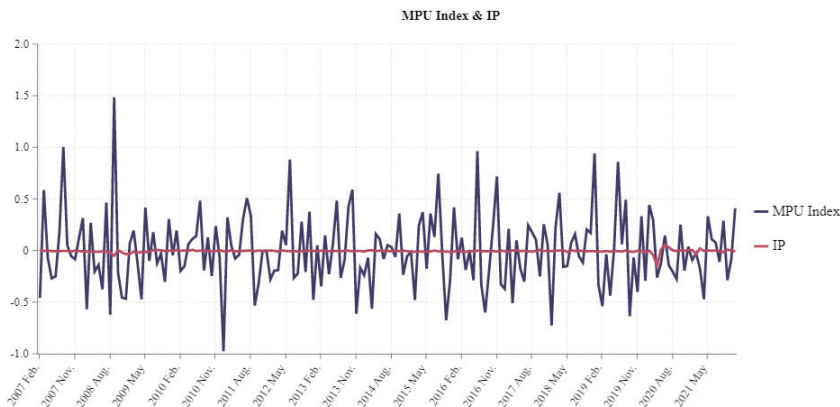

**Figure 1.** MPU Index, IP (overall index), and Stock Return (by countries)

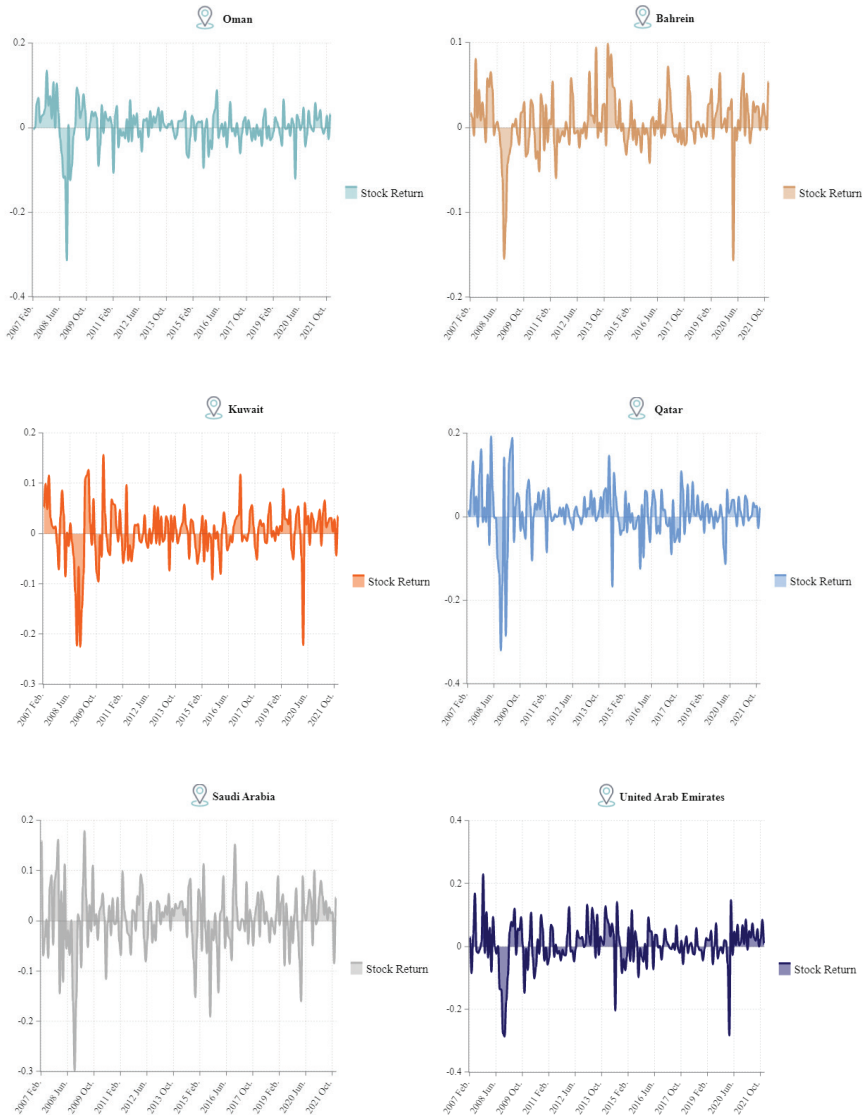

**Source:** By authors.

#### 4. Methodology

Utilizing the studies of Wen et al. (2022) and Paule-Vianez et al.(2020b), we evaluate the link between stock market returns, MPU, and IP in GCC countries within a panel data framework (Baltagi, 2013) as follows:

$$SR_{it} = \beta_0 + \beta_1 MPU_{it} + \beta_2 IP_{it} + \varepsilon_{it}$$

In our model,  $i$  and  $t$  represent the country and month, respectively.  $\beta_0$  denotes constant.  $\beta_1$  and  $\beta_2$  are the coefficients of MPU and IP, respectively.  $\varepsilon_{it}$  represents the disturbance.

We first test the cross-section dependence(CSD) among the GCC countries to identify the appropriate panel unit root(UR) test used to investigate the stationarity of the variables. To this end, we employ Breusch and Pagan LM Test (Breusch and Pagan, 1980) under the null of no CSD due to the large  $T$  in data set. After testing the CSD, we apply panel UR test, employing CIPS statistics, developed by (Pesaran, 2007) and MADF Panel UR test (Sarno and Taylor, 1998; Taylor and Sarno, 1998) under the null of UR as they allow for CSD across the GCC countries. In addition, we implement Augmented Dickey-Fuller (ADF) UR test (Dickey and Fuller, 1979, 1981), Philips-Perron (PP) UR test (Phillips and Perron, 1988) and Kwiatkowski, Philips, Schmidt and Shin (KPSS) UR test(Kwiatkowski et al., 1992) under the null of UR (for KPSS, null of stationarity) to investigate the the stationarity of cross-sectionally invariant variables in our model.

We utilize the MMQR introduced by Machado and Santos Silva (2019) to estimate the effect of MPU, and IP on stock market returns for seven quantiles. Among the seven quantiles, Q0.05, Q0.10, and Q0.25 denote the bearish market. Q0.5 represents the normal market. Finally, Q0.75, Q0.90, and Q0.95 show the bullish market. Moreover, we apply DH non-homogenous panel causality test developed by Dumitrescu and Hurlin (2012) to reveal the pairwise causal link across the stock market returns, MPU, and industrial production.

## 5. Results

Before estimating our model, utilizing the MMQR, we utilize several standard preliminary tests to capture the panel time series properties of the series. To abstain from spurious regression due to the non-stationary variables, we apply three different UR tests as mentioned in the section of methodology. Table 4 illustrates the results of UR tests for stationarity of the cross-sectionally invariant variables (MPU and IP). The findings clearly show that all three formal tests (ADF, PP, and KPSS) support each other in that MPU index and IP series are stationary.

**Table 4.** UR Tests Results

Variables	ADF UR Test		PP UR Test		KPSS UR Test	
	Intercept	Intercept& Trend	Intercept	Intercept& Trend	Intercept	Intercept& Trend
MPU Index	-10.93499***	-10.90754***	-24.75918***	-24.82826***	0.081534	0.074651
IP	-10.35887***	-10.35428***	-10.46272***	-10.44270***	0.059491	0.072045

*Note:* \*\*\* shows 1% level of significance.

For the stationarity of SR, we first perform the Breusch Pagan CSD test to check the presence of CSD across the GCC countries. Therefore, we avoid the over-rejection problem in panel UR tests for SRs (cross-sectionally variant variable). Breusch and Pagan LM test results in Table 5 show the existence of CSD across the GCC countries. Thus, we decide to implement the second-generation panel UR tests to remove the over-rejection problem. The results of CIPS and

**Table 5. Panel UR Tests and CSD Test Results**

	CIPS		MADF	Breusch & Pagan LM
Variable	Intercept	Intercept& Trend	Intercept	LM Statistic
Stock Return	-6.190***	-6.420***	962.333**	825.5048***

*Note: i.\*, \*\*, and \*\*\* show 10%, 5%, and 1% level of significance.*

*ii. The critical values for the CIPS test at 01%, 5% and 1% significance levels are -2.21, -2.32 and -2.53, respectively, the critical value of the MADF test at the 5% significance level is 14.719.*

MADF as second-generation panel UR rests are also given in Table 5. The CIPS and MADF panel UR tests results in Table 5 show that the SR variable is stationary. Hence, all of three variables used in our model are stationary. Therefore, we estimate our regression model, utilizing MMQR estimator in this paper. We illustrate the MMQR estimation results in Table 6. Table 6 shows

**Table 6. MMQR Estimation Results**

Regressors	Quantiles (Percentiles, %)						
	Q0.05	Q0.10	Q0.25	Q0.50 (LAD)	Q0.75	Q0.90	Q0.95
MPU Index	-0.01514 (0.01197) [-1.26]	-0.01618 (0.00986) [-1.64]	-0.01772** (0.00720) [-2.46]	-0.01911*** (0.00581) [-3.29]	-0.02049*** (0.00612) [-3.35]	-0.02199*** (0.00812) [-2.71]	-0.0233** (0.01055) [-2.21]
IP	1.50531** (0.66311) [2.27]	1.16475** (0.5373) [2.17]	0.66554* (0.39023) [1.71]	0.21235 (0.31536) [0.67]	-0.23763 (0.33366) [-0.71]	-0.72572 (0.44565) [-1.63]	-1.15038** (0.57710) [-1.99]
Intercept	-0.0758* (0.00667) [-11.37]	-0.0544 (0.00335) [-16.23]	-0.02267* (0.00192) [-11.84]	0.00686* (0.00171) [4.01]	0.03564* (0.00212) [16.81]	0.06730* (0.00391) [17.22]	0.094924* (0.00454) [20.92]

*Note: i.\*, \*\*, and \*\*\* show 10%, 5%, and 1% level of significance.*

*ii. Parentheses and brackets indicate standard errors and t statistics, respectively.*



that MPU index has no significant influence on SR at the lower quantiles of bearish market (Q0.05 and Q0.10). However, MPU index has significantly negative impact on SR at the higher quantile of bearish market (Q0.25), in normal market conditions, and bullish market in GCC countries. IP has significantly positive impact in bearish market and negative impact at the higher quantile of bullish market(Q0.95), while. IP has no significant effect on SR in normal market and at the lower quantile of bullish market (Q0.75 and Q0.90). We then test the pairwise causality, applying DH panel causality test and illustrate the results in Table 7. Table 7 shows no bidirectional causal relationship between

**Table 7. Panel Causality Test Results**

Direction of Causality		W Statistics	Z-bar Statistics	P-value	Direction Results
Stock Return	MPU	1.51	0.86	0.38	-
MPU Index	Stock Return	0.61	-0.67	0.50	-
Stock Return	IP	15.3***	24.27	0.00	
IP	Stock Return	2.17**	1.96	0.04	
MPU Index	IP	0.17	-1.41	0.15	-
IP	MPU Index	0.03*	-1.66	0.09	

*Note:\*, \*\*, and \*\*\* show 10%, 5%, and 1% level of significance.*

SR and MPU Index. Table 7 also illustrates a bidirectional causal relationship between SR and IP. Lastly, Table 7 presents no unidirectional causality running from the MPU index to IP, while a unidirectional causality running from IP to the MPU index.

## 6. Conclusions

In our paper, we evaluate the link between IP, MPU, and SRs in GCC countries, utilizing MMQR estimator and investigate the pairwise causal relationship between the mentioned variables, utilizing DH panel non-homogenous causality test employing monthly data for the period January 2007 -December 2021.

Our findings demonstrate that the MPU index has a significantly negative impact on SR at the higher quantile of bearish market (Q0.25), in normal market, and in bullish market in GCC countries. This result presents that a rise in the MPU index causes a reduction in SR in different market conditions of GCC countries. These findings are supported by the findings of Wen et al.(2022), Chiang (2021), and Paule-Vianez et al.(2020b). Our findings also demonstrate that IP has significantly positive impact in bearish market and negative impact at the higher quantile of bullish market.



This result indicate that a rise in IP leads to increase in bearish market and reduction at the higher quantile of bullish market. This finding, negative impact at the higher quantile of bullish market, is supported by (Paule-Vianez et al., 2020b). Finally, Our findings demonstrate a bidirectional causal relationship between SR and IP and a unidirectional causal relationship running from IP to MPU index

In this study, we acquire some findings regarding the GCC countries, implementing MMQR approach. These findings provide better information on the impact of MPU along with IP on stock markets in different market conditions in GCC countries. Therefore, investors can employ these findings to predict the response of stock markets in GCC countries.

## REFERENCE

- Baker, S. R., Bloom, N., & Davis, S. J. (2016). Measuring economic policy uncertainty. *Quarterly Journal of Economics*, 131(4), 1593–1636. <https://doi.org/10.1093/qje/qjw024>
- Baltagi, B. H. (2013). *Econometric Analysis of Panel Data - Fifth Edition*. In *John Wiley & Sons*, 2013.
- Breusch, T. S., & Pagan, A. R. (1980). The Lagrange Multiplier Test and its Applications to Model Specification in Econometrics. *The Review of Economic Studies*, 47(1), 239. <https://doi.org/10.2307/2297111>
- Cai, Y. (2018). Predictive Power of us Monetary Policy Uncertainty Shock on Stock Returns in Australia and New Zealand. *Australian Economic Papers*, 57(4), 470–488. <https://doi.org/10.1111/1467-8454.12130>
- Chiang, T. C. (2021). Spillovers of U.S. market volatility and monetary policy uncertainty to global stock markets. *North American Journal of Economics and Finance*, 58. <https://doi.org/10.1016/j.najef.2021.101523>
- Dickey, D. A., & Fuller, W. A. (1979). Distribution of the Estimators for Autoregressive Time Series with a Unit Root. *Journal of the American Statistical Association*, 74(366a), 427–431. <https://doi.org/10.1080/01621459.1979.10482531>
- Dickey, D. A., & Fuller, W. A. (1981). Likelihood Ratio Statistics for Autoregressive Time Series with a Unit Root. *Econometrica*, 49(4), 1057. <https://doi.org/10.2307/1912517>
- Dumitrescu, E. I., & Hurlin, C. (2012). Testing for Granger non-causality in heterogeneous panels. *Economic Modelling*, 29(4), 1450–1460. <https://doi.org/10.1016/j.econmod.2012.02.014>
- Ioannidis, C., & Kontonikas, A. (2008). The impact of monetary policy on stock prices. *Journal of Policy Modeling*, 30(1), 33–53. <https://doi.org/10.1016/j.jpolmod.2007.06.015>
- Jansen, D. W., & Tsai, C. L. (2010). Monetary policy and stock returns: Financing constraints and asymmetries in bull and bear markets. *Journal of Empirical Finance*, 17(5), 981–990. <https://doi.org/10.1016/j.jempfin.2010.08.002>
- Kwiatkowski, D., Phillips, P. C. B., Schmidt, P., & Shin, Y. (1992). Testing the null hypothesis of stationarity against the alternative of a unit root. *Journal of Econometrics*, 54(1–3), 159–178. [https://doi.org/10.1016/0304-4076\(92\)90104-Y](https://doi.org/10.1016/0304-4076(92)90104-Y)
- Machado, J. A. F., & Santos Silva, J. M. C. (2019). Quantiles via moments. *Journal of Econometrics*, 213(1), 145–173. <https://doi.org/10.1016/j.jeconom.2019.04.009>

- Paule-Vianez, J., Gómez-Martínez, R., & Prado-Román, C. (2020). Effect of Economic and Monetary Policy Uncertainty on stock markets. Evidence on return, volatility and liquidity. *Economics Bulletin*, 40(2), 1261–1271.
- Paule-Vianez, J., Prado-Román, C., & Gómez-Martínez, R. (2020). Monetary policy uncertainty and stock market returns: influence of limits to arbitrage and the economic cycle. *Studies in Economics and Finance*, 37(4), 777–798. <https://doi.org/10.1108/SEF-04-2020-0102>
- Pesaran, M. H. (2007). A Simple Panel Unit Root Test in the Presence of Cross-Section Dependence. *Journal of Applied Econometrics*, 22, 265–312. <https://doi.org/10.1002/jae>
- Phillips, P., & Perron, P. (1988). Testing for a Unit Root in Time Series Regression. *Biometrika*, 75(2), 335–346.
- Sarno, L., & Taylor, M. P. (1998). Real exchange rates under the recent float: unequivocal evidence of mean reversion. In *Economics Letters* (Vol. 60).
- Taylor, M. P., & Sarno, L. (1998). The behavior of real exchange rates during the post-Bretton Woods period. In *Journal of International Economics* (Vol. 46).
- Tiryaki, A., Ceylan, R., & Erdoğan, L. (2019). Asymmetric effects of industrial production, money supply and exchange rate changes on stock returns in Turkey. *Applied Economics*, 51(20), 2143–2154. <https://doi.org/10.1080/00036846.2018.1540850>
- Wen, F., Shui, A., Cheng, Y., & Gong, X. (2022). Monetary policy uncertainty and stock returns in G7 and BRICS countries: A quantile-on-quantile approach. *International Review of Economics and Finance*, 78, 457–482. <https://doi.org/10.1016/j.iref.2021.12.015>